

*InSight*TM V5

Veterinary Haematology Analyser Operator's Manual



 **PRAXISDIENST**
Medical Supplies since 1953

 **Order here!**



Preface

Thank you for purchasing the InSight V5 Veterinary Haematology Analyser manufactured by Woodley Equipment Company.

Please read and understand the entire operator's manual before operating this device. Store this operator's manual properly for future reference.

Product Name: Veterinary Haematology Analyser

Model: InSight V5

Product Components: Blood Aspiration Module, Dilution Unit, Cleaning Unit, Analysing and Measuring Unit and Microprocessor

Scope of Use: blood cell counting, white blood cell 5-part classification and haemoglobin concentration measurement in clinical examinations

Contact Info for After-Sales Services



Woodley Equipment Company Ltd

Old Station Park Buildings, St John Street, Horwich, Bolton, Lancashire, BL6 7NY, UK

Tel: +44 (0) 1204 669033

Fax: +44 (0) 1204 669034

Email: sales@woodleyequipment.com

Website: www.woodleyequipment.com

Copyright

© Woodley Equipment Company Ltd. All rights reserved. This document contains proprietary information of Woodley Equipment Company Ltd. No part of this document may be reproduced, copied, modified, disclosed, or transmitted in any form or by any means without prior written consent of Woodley Equipment Company. This document is intended for users of Woodley Equipment Company equipment, whom are authorised to use this document as they purchase Woodley Equipment Company equipment. Unauthorised persons are not allowed to use this document.

All information in this document does not constitute a warranty of any kind, express or implied, including, but not limited to, the implied warranties of merchantability and fitness for a particular purpose. Every effort has been made in the preparation of this document to ensure accuracy of the contents. However, Woodley Equipment Company assumes no liability or responsibility for any errors or omissions in the contents of this document. Woodley Equipment Company reserves the right to improve any products to enhance product reliability, functionality, or design.

InSight V5 is a trademark of Woodley Equipment Company Ltd.

Declaration

This operator's manual may be modified without notice.

Woodley Equipment Company reserves the right of final interpretation of this operator's manual.

The pictures in this operator's manual are for reference only. If there is inconsistency between the pictures and the actual product, the actual product shall prevail. Do not use the pictures for anything other than intended use.

Woodley Equipment Company shall be responsible for the safety, security, and performance of the product only when all of the following conditions are met:

- The assembly, re-commissioning, extension, modification, and repair of the product are performed by the authorised personnel of Woodley Equipment Company.
- The product is operated based on this operator's manual.
- The electrical appliances in the relevant working room comply with applicable national and local requirements.

Contents

Preface	i
Copyright	ii
Contents	vii
1 Manual Overview	1
1.1 Introduction	1
1.2 Who Should Read This Manual	1
1.3 How to Find Information.....	1
1.4 Conventions Used in This Manual	2
1.5 Symbol Conventions	2
1.6 Safety Information.....	5
2 Installation	6
2.1 Introduction	6
2.2 Installation Personnel	6
2.3 Installation Requirements	6
2.4 Damage Inspection	8
2.5 Unpacking	8
2.6 Connecting the Analyser System.....	9
2.6.1 Electrical Connections.....	9
2.6.2 Reagent Connections.....	9
2.6.3 Installing the Diluent Float Sensor and Replacing the Reagents.....	10
2.6.4 Installing the Waste Float Sensor	11
2.6.5 LIS Connection.....	12
2.7 Installing Thermal Paper	15
3 System Overview	17
3.1 Introduction	17
3.2 Who Should Read This Manual	17
3.3 Measurement Parameters	17
3.4 Structure of the Analyser	19
3.4.1 Main unit.....	19
3.4.2 Touch screen	21
3.4.3 Aspirate key.....	21
3.4.4 Power/Status indicator	21
3.4.5 Power switch	21
3.4.6 Thermal Printer.....	22
3.4.7 Paper Feed Key	22
3.4.8 Key for opening the paper compartment of the thermal printer	22
3.4.9 USB interface	22
3.4.10 Network interface	22
3.4.11 External Equipment (Optional)	22
3.5 User Interface	23
3.6 Reagents, Controls and Calibrators	24
3.6.1 Reagents.....	25

3.6.2 Controls and Calibrators	25
4 Working Principle	26
4.1 Introduction	26
4.2 Aspiration	26
4.3 Dilution	26
4.3.1 Dilution Procedure in Whole-blood CBC+DIFF Mode.....	27
4.3.2 Dilution Procedure in Predilute CBC+DIFF Mode.....	28
4.4 WBC Measurement	28
4.4.1 Working Principle of Laser-based Flow Cytometry	28
4.4.2 Derivation of WBC-Related Parameters	30
4.5 HGB Measurement	31
4.5.1 Colorimetric Method	31
4.5.2 HGB.....	31
4.6 RBC/PLT Measurement	31
4.6.1 Electrical Impedance Method.....	31
4.6.2 RBC.....	32
4.6.3 PLT	33
4.7 Flushing	33
5 Setup.....	34
5.1 Introduction	34
5.2 Interface Introduction	34
5.3 System Settings	35
5.3.1 Date and Time	35
5.3.2 Input Settings	37
5.3.3 Lab Information	37
5.3.4 Auto Maintenance	39
5.3.5 Self-programmed Species.....	39
5.4 Parameter Settings	42
5.4.1 Parameter Unit	42
5.4.2 Ref. Range	44
5.4.3 Customised Parameters.....	48
5.5 Meterage Settings.....	51
5.5.1 Gain Settings.....	51
5.5.2 Flag	52
5.6 Communication Settings.....	53
5.6.1 Host Network Settings.....	53
5.6.2 LIS Communication	55
5.7 User management	59
5.7.1 Accessing the Interface	60
5.7.2 Creating a User	60
5.7.3 Editing a User.....	61
5.7.4 Deleting a User	61
5.7.5 Setting the Default User	61
5.7.6 Changing Password	62
5.7.7 Resetting Password	63

5.8 Print Settings.....	63
5.9 Auxiliary Settings	68
5.10 Thermal Printer Settings	71
6 Daily Operations	72
6.1 Introduction	72
6.2 Pre-operation Preparation	72
6.3 Startup	73
6.4 Daily Quality Control	75
6.5 Sample Collection and Handling.....	75
6.5.1 Running the Whole Blood Samples	75
6.5.2 Prediluted Samples	76
6.6 Sample Analysis.....	78
6.7 Shutdown	78
7 Sample Analysis	80
7.1 Introduction	80
7.2 Interface Introduction	80
7.3 Entering Sample Information	82
7.4 Running Samples	86
7.5 Dealing with the Analysis Results	87
7.5.1 Automatic saving of analysis results	87
7.5.2 Parameter Flags.....	87
7.5.3 Flags of Abnormal Blood Cell Differential or Morphology	87
7.6 Functions of the Buttons	90
7.6.1 Previous/Next.....	90
7.6.2 Next Sample.....	90
7.6.3 Validate/Cancel Validation.....	90
7.6.4 Print.....	90
7.6.5 Sample Information	91
7.6.6 Customised Parameters.....	94
7.6.7 Communication	95
7.6.8 Edit Result	96
7.6.9 Delete	97
8 Result Review	98
8.1 Introduction	98
8.2 Interface Introduction	98
8.3 Sample List	99
8.4 Functions of the Buttons	99
8.4.1 Validate.....	99
8.4.2 Cancel Validation.....	100
8.4.3 Print.....	101
8.4.4 Sample Info.	101
8.4.5 Graph	104
8.4.6 Run Chart.....	105
8.4.7 Customised Parameters.....	108
8.4.8 Export	108

8.4.9 Edit Result	112
8.4.10 Query	112
8.4.11 Delete	114
8.4.12 Communication	115
9 Quality Control.....	118
9.1 Introduction	118
9.2 L-J Quality Control	118
9.2.1 QC Principle	118
9.2.2 QC Settings.....	119
9.2.3 Quality Control Analysis	128
9.2.4 QC Result Review	135
10 Calibration	147
10.1 Introduction	147
10.2 When to Calibrate	147
10.3 How to Calibrate	148
10.3.1 Preparation.....	148
10.3.2 Manual Calibration	149
10.3.3 Auto Calibration Using Calibrators	151
10.4 Verifying Calibration Coefficients	153
11 Reagent Management.....	154
11.1 Accessing the Interface.....	154
11.2 Setting Reagent Information	155
11.2.1 Open system	155
11.2.2 Closed system.....	157
11.3 Replacing Reagents.....	159
12 Service	160
12.1 Introduction	160
12.2 Maintenance	160
12.2.1 Reagent Replacement	160
12.2.2 Cleaning	162
12.2.3 Maintenance.....	164
12.2.4 Comprehensive Device Maintenance	168
12.2.5 Auto Clean.....	173
12.2.6 Auto Prompt for Cleanser Soak	173
12.2.7 Auto Sleep.....	174
12.3 Self-test.....	174
12.3.1 Syringe and Sampling Mechanism	175
12.3.2 Pressure and Vacuum.....	175
12.3.3 Valve & Pump.....	176
12.3.4 Others.....	177
12.4 System Status.....	178
12.4.1 Temperature	178
12.4.2 Voltage and Current	179
12.4.3 Disk Information	180

12.5 Data Cleanup	180
12.6 Version Information	182
12.7 Screen Test	183
12.8 Touch Screen Calibration	184
12.9 Log	184
12.9.1 All Logs	185
12.9.2 Parameter Revision Logs	185
12.9.3 Fault Logs	186
12.9.4 Other Logs	187
12.10 Downloading Service Logs	188
13 Troubleshooting	189
13.1 Introduction	189
13.2 Dealing with Error Messages	189
13.3 Error Message Reference	190
Appendix A Specifications	195
A.1 Classification	195
A.2 Reagents	195
A.3 Parameters	195
A.4 Performance Specifications	196
A.4.1 Display Range	196
A.4.2 Normal Background	197
A.4.3 Linearity Range	197
A.4.4 Repeatability	197
A.4.5 Carryover	199
A.5 Sample Interference	200
A.6 Input/output Device	201
A.7 Power	201
A.8 Fuse	201
A.9 EMC Description	201
A.10 Environment Conditions	202
A.11 Dimensions and Weight	203
A.12 Contraindications	203
Appendix B Terms and Abbreviations	204
Appendix C Packing List	205

1 Manual Overview

1.1 Introduction

This chapter explains how to use this operator's manual of the InSight V5 Haematology Analyser, which is shipped with the analyser and contains reference information about the analyser and procedures for operating, troubleshooting and maintaining the analyser.

Read this manual carefully before operating the analyser and operate your analyser in strict accordance with this manual.

1.2 Who Should Read This Manual

This manual contains information written for clinical laboratory professionals to:

- Learn about the hardware and software of the analyser.
- Customise system settings.
- Perform daily operations.
- Perform system maintenance and troubleshooting.

1.3 How to Find Information

This operator's manual comprises 13 chapters and 3 appendices. Find the information you need by referring to the table below.

See...	You can find...
1 Manual Overview	Instructions for using the auto haematology analyser..
2 Installation	Installation requirements for the auto haematology analyser..
3 System Overview	Applications, measurable parameters, instrument configuration, software interface and software operations of the auto haematology analyser..
4 Working Principle	Measuring principle and procedures of the auto haematology analyser..
5 Setup	Settings of the system parameters such as the software date format and parameter units.
6 Daily Operations	Daily operations such as sample collection and preparation, the analysis procedures, startup and shutdown of the instrument.
7 Sample Analysis	Sample analysis procedure and handling of the analysis results.

See...	You can find...
8 Result Review	Review of the analysis results.
9 Quality Control	Basic requirements for quality control and the quality control methods provided by the auto haematology analyser..
10 Calibration	Basic requirements for calibration and the calibration methods provided by the auto haematology analyser..
11 Reagent Management	Settings and management of the reagents for the auto haematology analyser..
12 Service	Methods for maintaining and testing the auto haematology analyser..
13 Troubleshooting	Troubleshooting methods for the auto haematology analyser..
Appendix A Specifications	Specification indicators of the auto haematology analyser..
Appendix B Terms and Abbreviations	Terms and abbreviations for the auto haematology analyser..
Appendix C Packing List	Packing list for the auto haematology analyser..



1.4 Conventions Used in This Manual



The texts with special meaning in the manual are highlighted by different fonts and formats.

Format	Meanings
[XX]	All uppercase characters enclosed in [] indicate the name of a key on the analyser or the peripheral keyboard, such as [ENTER].
XX	Bold characters indicate text displayed on the screen, such as Report .
XX	XX indicates variables and the specific content depends on the actual situation.
<i>XX</i>	Bold and italic characters indicate chapter titles, such as <i>1.1 Introduction</i> .

1.5 Symbol Conventions

The following symbols are used to indicate danger and alert messages in this manual.







When you see ...	Then ...
	Follow the instruction below the symbol to avoid potential biocontamination.
 WARNING	Follow the instruction below the symbol to avoid personnel injury.















When you see ...	Then ...
 CAUTION	Follow the instruction below the symbol to avoid analyser damage and failure, or unreliable analysis results.
NOTE	Follow the instruction below the symbol. The symbol highlights the important information in operating procedures that calls for special attention.
	Puncture Warning: The sampling probe is sharp and may contain biohazardous materials. Special care should be taken when working with it.
	Laser Warning: This sign serves as a reminder of laser radiation.

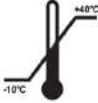

The analyser or the outer packaging may have the following labels or symbols.

NOTE

- If the labels are damaged or missing, please contact Woodley Equipment Company or Woodley Equipment Company's agents for replacement.
- All illustrations in this manual are provided as references only. They may not necessarily reflect actual analyser configuration or display.

When you see ...	It means
	Caution
	Biohazard
	Exercise caution to prevent puncture
	Laser radiation warning: It is a Class 3R laser product with 5.0 mW of maximum power output at 635 nm. Avoid direct eye exposure to the laser beam.
	Instruction for Moving
	Network interface
	Protective grounding

When you see ...	It means
	Alternating current (AC)
	Lot Number
	Expiry date
	Serial number
	European CE declaration of conformity
	Date of manufacture
	Manufacturer
	Storage temperature
	Humidity level for storage
	Atmospheric pressure level for storage
	Consult the operator's manual
	Keep away from sunlight
	Keep dry
	No rolling
	No Stacking
	Let this side face upward

When you see ...	It means
	Fragile, handle with care
	Recyclable materials
	The analyser, after being scrapped, should not be disposed with other household garbage; instead, it should be collected and recycled following the disposal instructions for scrapped electronic and electrical equipment.

1.6 Safety Information



- All the samples, controls, calibrators, reagents, wastes and areas in contact with them are potentially biohazardous. Wear proper personal protective equipment (e.g. gloves, lab uniforms, etc.) and follow laboratory safety procedures when handling them and the relevant areas in the laboratory.
- If the analyser leaks, the leaked liquid is potentially biohazardous.



WARNING

- Please check the firmness of all the doors/covers/panels before running the analyser to prevent unexpected opening or loosening when the analyser is working.
- Make sure all the safety measures are taken. Do not disable any safety device or sensor.
- Please respond to any alarm or error message immediately.
- Do not touch the moving parts.
- Contact Woodley Equipment Company or Woodley Equipment Company-authorized agents upon the identification of any damaged part.
- Be careful when opening/closing and removing/installing the doors, covers and panels of the analyser.
- Dispose of the analyser according to government regulations.



CAUTION

- Please use the analyser in strict accordance with this manual.
- Please take proper measures to prevent the reagents from being polluted.

2 Installation

2.1 Introduction



WARNING

Installation by personnel not authorised or trained by Woodley Equipment Company may cause personal injury or damage to the analyser. Do not install the analyser without the presence of Woodley-authorised personnel.

Your analyser has passed strict tests before it was shipped from the factory.

Internationally-recognized symbols and instructions show the carrier how to properly handle this electronic instrument in transportation. When you receive your analyser, carefully inspect the packaging. If you see any sign of mishandling or damage, contact our customer service department or your local agent immediately.

2.2 Installation Personnel

The analyser should only be installed by Woodley Equipment Company or its authorised agents. You need to provide the appropriate environment and space. When the analyser needs to be relocated, please contact Woodley Equipment Company or your local agents.

When you receive the analyser, please notify Woodley Equipment Company or your local agent immediately.

2.3 Installation Requirements



WARNING

- Connect only to a properly grounded outlet.
 - Before turning on the analyser, make sure the input voltage meets the requirements.
 - To prevent fire, use the fuses with specified model number and working current.
-

**CAUTION**

- Using a patch board may introduce electrical interference and generate incorrect analysis results. Please place the analyser near the electrical outlet to avoid using the patch board.
- Please use the original electrical wires shipped with the analyser. Using other electrical wires may damage the analyser or generate incorrect analysis results.

Installation requirements for the analyser are as follows.

Installation Environment	Requirements
Site	<ul style="list-style-type: none"> • Level ground and stable workbench with load capacity $\geq 50\text{kg}$. • Free of dust, mechanical vibration, heat and wind sources, contamination, heavy-noise source or electrical interference. • Avoid direct sunlight and keep good ventilation. • It's recommended to evaluate the electromagnetic environment of the laboratory before operating the analyser. • Keep the analyser away from sources of strong electromagnetic interference, otherwise, its proper functioning may be affected.
Space (In addition to the space required for the analyser itself, set aside:)	<ul style="list-style-type: none"> • At least 50 cm from each side, which is the preferred access to perform service procedures. • At least 20 cm from the back for cabling and ventilation. • Enough room on and below the countertop to accommodate for the diluent and waste containers. • Place the analyser near the electrical outlet and avoid being blocked by any objects, so that you can disconnect the power plug easily as required.
Temperature	10°C~30°C (50°F~86°F)
Relative humidity	20%~85%
Operating atmospheric pressure	70kPa~106kPa
Ventilation	Keep air exchange to ensure good air circulation. The wind should not blow directly at the analyser.
Power Requirements	AC100V~240V, Input Power $\leq 200\text{VA}$, 50/60HZ.
Electromagnetic Wave	Keep the analyser away from electric-brush motors, flashing fluorescent and electric-contact equipment which is switched on/off frequently.
Waste Disposal	Dispose of the waste as per the requirements of the local environment protection authorities.

2.4 Damage Inspection

Before packing and shipping, Woodley Equipment Company has applied rigid inspection on the analyser. Upon receiving the analyser, please check carefully before unpacking to see if there are any of the following damages:

- The outer packaging is placed upside down or distorted.
- The outer packaging shows obvious signs of having been exposed to humid conditions.
- The outer packaging shows obvious signs of having been crashed.
- The outer packaging shows signs of having been opened.

Once you find the above damages, please notify your local agent immediately.

If the packaging is intact, please open the packaging in the presence of personnel from Woodley Equipment Company or its agents and apply the following inspections:

- Check if all the items listed in the packing list are in the packaging.
- Carefully inspect the appearance of all the items to check if they are damaged or distorted.

2.5 Unpacking

Please unpack the analyser by taking the following steps:

1. Open the outer packing box; take out the accessory pack; take out the analyser together with the protective and cushioning materials.
2. Remove the foam and the protective PE bag.
3. Open the right door (open the linear-shaped cam lock on the right door with a slotted screwdriver).
4. Remove the binder clips, which are used for fixating two conveyor belts.

To avoid the possible collision resulting from the slippage caused by shaking and slanting during transportation, the central position of those two belts is fixated with binder clips before they are shipped from the factory. The binder clips must be removed during unpacking.

5. Remove the binder clips, which are used for fixating sampling assembly.

NOTE

To avoid damage during the transportation, the sampling assembly of the analyser is fixated with clamps. Remove the clamps before using the analyser.

2.6 Connecting the Analyser System

2.6.1 Electrical Connections

Please refer to Figure 2-1 for the electrical connections of the analyser.

Figure 2-1 Connecting the electrical devices

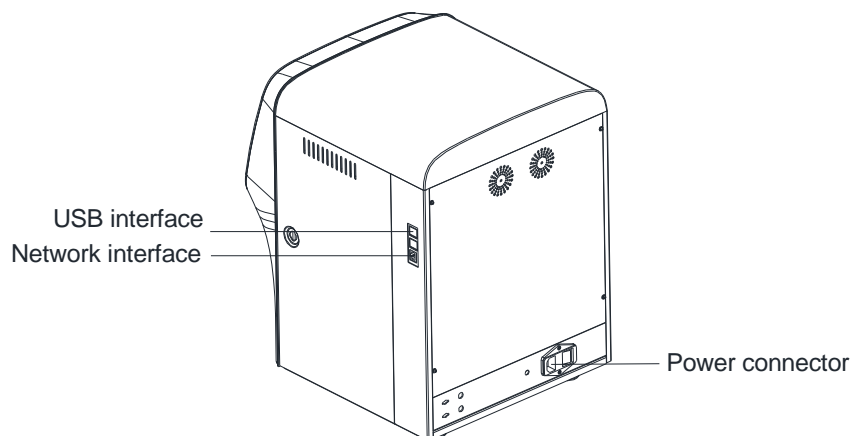

2.6.2 Reagent Connections



WARNING

- Be sure to dispose of reagents, waste, samples, consumables, etc. according to local legislations and regulations.
- Reagents can be irritating to the eyes, skin, and mucosa. Wear proper personal protective equipment (e.g. gloves, lab uniforms, etc.) and follow laboratory safety procedures when handling them in the laboratory.
- If the reagent accidentally comes in contact with your eyes or skin, rinse immediately with water



CAUTION

- Please make sure the length of the diluent pipe and the waste pipe should be no longer than 1500mm; the length of the lyse pipe and the cleanser pipe should be no longer than 850mm.
- Tighten the panel connector of the fluidic line so that the overall fluidic line is closed to prevent leakage and seepage caused by siphonage, etc.

Refer to Figure 2-2 for the connection of the reagents placed outside the analyser.

Figure 2-2 Connecting reagents placed outside the analyser

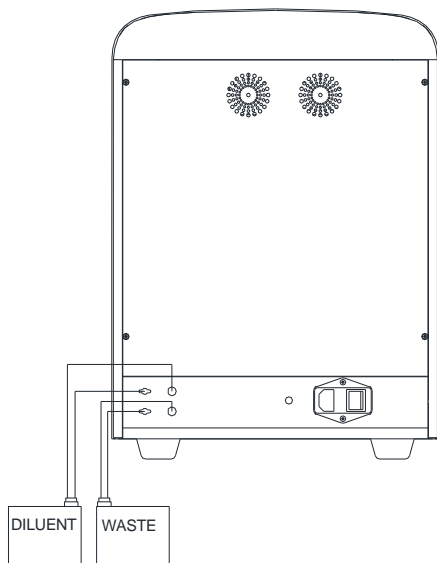

Refer to Figure 2-3 for the connection of the reagent placed inside the analyser.

Figure 2-3 Connecting reagents placed inside the analyser (left door opened)

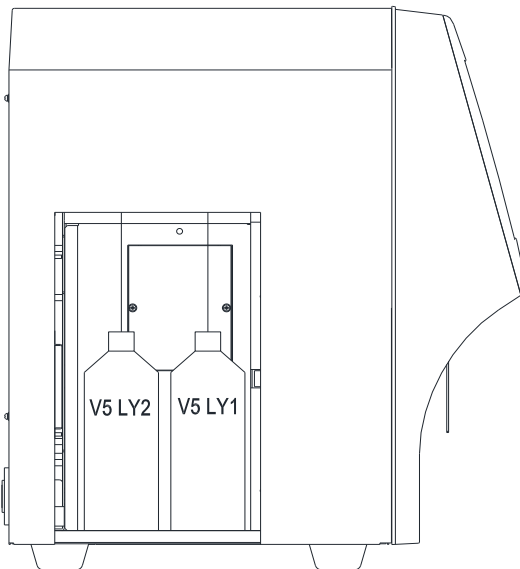

2.6.3 Installing the Diluent Float Sensor and Replacing the Reagents

Please install the diluent float sensor and replace the diluent as per the approaches stated in this section.

2.6.3.1 Installing the Diluent Float Sensor

Install the diluent float sensor according to the following steps.

1. Press down and remove the round cardboard with dotted cutting line on the top side of the diluent box so as to reveal a round hole.
2. Pull out the cover of the container, so that the cardboard around the round hole can seize the neck under the vial cap to prevent invagination.
3. Turn and open the cap (keep the cap) and prevent any foreign objects from getting into the container.
4. Install the diluent float sensor assembly in the accessory pack as shown in Figure 2-4. The float sensor should be kept as vertical as possible during installation and the self-contained cap of the sensor should be tightened.

Figure 2-4 Installing the Diluent Float Sensor

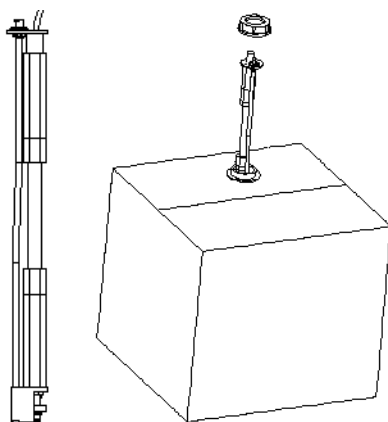

2.6.3.2 Replacing Reagents

The stages for replacing the diluent are the same as those for installing the sensor. Please keep the empty diluent container and the cap for future use.

2.6.4 Installing the Waste Float Sensor

NOTE

The float sensors used in the analyser are only applicable to Woodley Equipment Company-supplied waste containers or the containers with the same specification and model (such as the vacant diluent container).

1. Take a proper waste container (it can be a vacant diluent container, the opening of which is required to be pulled out of the hole of the box to expose the opening) and open the vial cap.
2. Install the waste float sensor assembly in the accessory pack as shown in Figure 2-5. The float sensor should be kept as vertical as possible during installation and the self-contained cap of the sensor should be tightened at the same time to prevent the spilling of the waste.

Figure 2-5 Installing the Waste Float Sensor

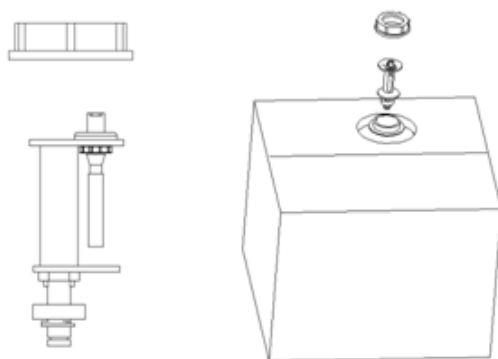

The waste container can be replaced according to the steps mentioned above. The replaced waste should be properly disposed to avoid contamination.



WARNING

Be sure to dispose of reagents, waste, samples, consumables, etc. according to local legislations and regulations.

2.6.5 LIS Connection

If the analyser needs to be connected to laboratory information system (hereinafter referred to as LIS), you can complete the connection by following the steps in this section.

2.6.5.1 Installing LIS Workstation

1. Install LIS workstation and set instrument type and model.
2. Enter LIS workstation network setup interface after installation and set monitoring IP address and port number.

NOTE

Refer to *Description of LIS Communication Protocol for Haematology Analysers* to complete the support of the LIS workstation to the LIS communication protocol.

2.6.5.2 Host Communication Settings

1. Use a network cable to connect the analyser to LIS local area network.
2. Log on the InSight V5 Haematology Analyser software; if the analyser is turned on, skip this step. For details, see **6.3 Startup**, the whole process lasts for 4 to 12 minutes.
3. In the **Setup** interface, click **Host Communication** in the **Communication** selection to access the Laboratory Information System (LIS) communication setting interface, see figure below.

Host Communication

You can get IP settings assigned automatically if your network supports this capability. Otherwise, you need to ask your network administrator for the appropriate IP settings.

Obtain an IP address automatically

Use the following address:

IP Address

Subnet mask

Default gateway

Obtain DNS server address automatically

Use the following DNS server addresses:

Preferred DNS server

Alternate DNS server

Details Apply OK Cancel

4. Set the IP address and other network information of the analyser according to the actual situation.
 - If the network is accessed through a router on the site, please select **Obtain an IP address automatically** and **Obtain DNS server address automatically**.
 - If the network is accessed through a network switch, or the analyser is directly connected to the LIS on the site, please select **Use the following address**, so as to manually set the IP address and subnet mask of the analyser. The IP addresses of the analyser and LIS must be in the same network segment. Furthermore, their subnet masks shall be the same, while other parameters can maintain null.
5. Click **OK** to save the settings and close the dialog box.

2.6.5.3 Connecting Analyser with LIS

1. Log on the InSight V5 Haematology Analyser software; if the analyser is turned on, skip this step. The whole process lasts for 4 to 12 minutes.
2. In the **Setup** interface, click **LIS Communication** in the **Communication** selection to access the Laboratory Information System (LIS) communication setting interface. See figure below.

LIS Communication

Network Settings
 IP Address: 192 . 168 . 8 . 206 Port: 5600 [Reconnect]

Transmission Settings
 Auto-communication
 Bidirectional LIS/HIS Communication
 Bidirectional LIS/HIS Communication Timeout: [-] 10 [+] Sec.

Protocol Settings
 Communication Acknowledgement ACK timeout: [-] 10 [+] Sec.

Graph Format: PNG
 Histogram Transmission Method: Not transmit
 Scattergram Transmission Method: Not transmit

DIFF Scattergram: LS-MS LS-HS HS-MS
 BASO Scattergram: LS-MS

[Apply] [OK] [Cancel]

3. Input the IP address and port of LIS workstation in **Network Settings** area.
 Find the IP address and port of LIS in the network setup interface in the LIS workstation; if IP address can't be found, try the method below:
 - a. Enter the operating system of LIS workstation.
 - b. Press combination key [Windows+R] to open the **Run** window.
 - c. Input cmd, and then click **OK**.
 - d. Input the ipconfig command into the **cmd.exe** window popped out.

The interface shows similar content as follows:

```

C:\Windows\system32\cmd.exe
Copyright (c) 2009 Microsoft Corporation. All rights reserved.
C:\Documents and Settings\Administrator>ipconfig

Windows IP Configuration

Ethernet adapter Local Area Connection:

    Connection-specific DNS Suffix  . : 
    IPv4 Address. . . . . : 10.0.0.102
    Subnet Mask . . . . . : 255.255.255.0
    Default Gateway . . . . . : 10.0.0.1

Ethernet adapter Local Area Connection 2 :

    Connection-specific DNS Suffix  . : 
    IPv4 Address. . . . . : 192.168.8.44
    Subnet Mask . . . . . : 255.255.255.0
    Default Gateway . . . . . : 192.168.8.254



C:\Documents and Settings\Administrator>
  
```

The IPv4 address in the red box is the IP address of LIS workstation.

NOTE

The IP address **192.168.8.44** of the LIS workstation shown as above is used as an example, real IP should be in the same network segment with LIS server.

4. Click **OK** to save the settings.
5. Check if the connection is successful.

The LIS icon in the upper right side on the analyser screen turns from grey  to black , which indicates the InSight V5 Haematology Analyser software is connected to LIS successfully. If the icon stays grey, the connection fails. Please check if the IP address and port of LIS is correct and reconnect as the steps above; if the problem still exists, please contact the hospital network administrator to handle it.

2.7 Installing Thermal Paper

**CAUTION**

- Use only specified thermal paper. Otherwise, it may cause damage to the thermal printer head, or the printer may be unable to print, or poor print quality may result.
- Never pull the thermal printer paper with force when a recording is in process. Otherwise, it may cause damage to the thermal printer.
- Do not leave the thermal printer door open unless you are installing paper or removing error.
- Improper installation of thermal printer paper may jam the paper and/or result in blank printout.

NOTE

Remove the protective paper between the thermal printer head and the roller inside the thermal printer before installing thermal paper for the first time.

Follow the procedure below to install the thermal paper.

1. Use the latch (as shown in Figure 2-6) at the upper right corner of the thermal printer door to pull the door open.

Figure 2-6 Installing Thermal Paper (1)



2. Insert a new roll into the compartment as shown below.

Figure 2-7 Installing Thermal Paper (2)



3. Close the thermal printer door.
4. Check if paper is installed correctly and the paper end is feeding from the top.

Figure 2-8 Installing Thermal Paper (3)



5. To ensure the normal use of the thermal paper, press the feed key to start paper feeding, and then press the feed button again to stop feeding when a short paper is sent out.

3 System Overview

3.1 Introduction

The InSight V5 Veterinary Haematology Analyser is a quantitative, automated haematology analyser and 5-part differential counter for animal blood samples in clinical laboratories.

This section describes in details the intended use, measurement parameters, structure, user interface and compatible reagents of the analyser.

3.2 Who Should Read This Manual

The analyser is intended for blood cell counting, 5-part classification of white blood cell and haemoglobin concentration measurement for animal blood samples in clinical examinations.

NOTE

The analyser is intended for screening in the clinical examination. When making clinical judgment based on the analysis results, the veterinarian should also take into consideration the clinical examination results or other test results.

3.3 Measurement Parameters

The analyser performs sample analysis for different parameters according to different measurement modes (CBC or CBC+DIFF).

- In CBC+DIFF mode, the analyser provides quantitative analysis results for 23 haematology parameters, 3 histograms, 1 BASO scattergram and 3 DIFF scattergrams.
- In CBC mode, the analyser provides quantitative analysis results for 13 haematology parameters, 3 histograms, and one BASO scattergram.

Refer to the table below for the detailed parameters.

Type	Parameter Name	Abbreviation	CBC	CBC+DIFF
WBC (11 items)	White Blood Cell count	WBC	*	*
	Percentage of Neutrophils	Neu%	/	*
	Percentage of Lymphocytes	Lym%	/	*
	Percentage of Monocytes	Mon%	/	*
	Percentage of Eosinophils	Eos%	/	*

Type	Parameter Name	Abbreviation	CBC	CBC+DIFF
	Percentage of Basophils	Bas%	/	*
	Number of Neutrophils	Neu#	/	*
	Number of Lymphocytes	Lym#	/	*
	Number of Monocytes	Mon#	/	*
	Number of Eosinophils	Eos#	/	*
	Number of Basophils	Bas#	/	*
RBC (8 items)	Red Blood Cell count	RBC	*	*
	Haemoglobin Concentration	HGB	*	*
	Mean Corpuscular Volume	MCV	*	*
	Mean Corpuscular Haemoglobin	MCH	*	*
	Mean Corpuscular Haemoglobin Concentration	MCHC	*	*
	Red Blood Cell Distribution Width - Coefficient of Variation	RDW-CV	*	*
	Red Blood Cell Distribution Width - Standard Deviation	RDW-SD	*	*
	Haematocrit	HCT	*	*
PLT (4 items)	Platelet count	PLT	*	*
	Mean Platelet Volume	MPV	*	*
	Platelet Distribution Width	PDW	*	*
	Plateletcrit	PCT	*	*
Histogram (3 items)	White Blood Cell Histogram	WBC Histogram	*	*
	Red Blood Cell Histogram	RBC Histogram	*	*
	Platelet Histogram	PLT Histogram	*	*
Scattergram	Differential Scattergram	DIFF Scattergram	/	*
	Basophils Scattergram	BASO Scattergram	*	*

NOTE

“*” means the parameter is provided in the mode. “/” means the parameter is not provided.

3.4 Structure of the Analyser



WARNING

- Please check the firmness of all the doors, covers and boards before running the analyser.
- The analyser is heavy, so moving by one person alone may cause injury. It is advisable for two people to move it together when the transportation is necessary, and make sure you follow the instructions and use the proper tools.
- Connect only to a properly grounded outlet.
- To avoid electrical shocks, disconnect the power supply before opening the cover.



The sampling probe is sharp and may contain biohazardous materials. Special care should be taken when working with it.



This sign warns of laser radiation. Do not look directly at the laser beams or the optical instrument.

3.4.1 Main unit

The Auto haematology analyser. consists of the main unit (analyser) and accessories. The main unit is the main part for analysis and data processing.

- Front of the analyser

Figure 3-1 Front of the analyser

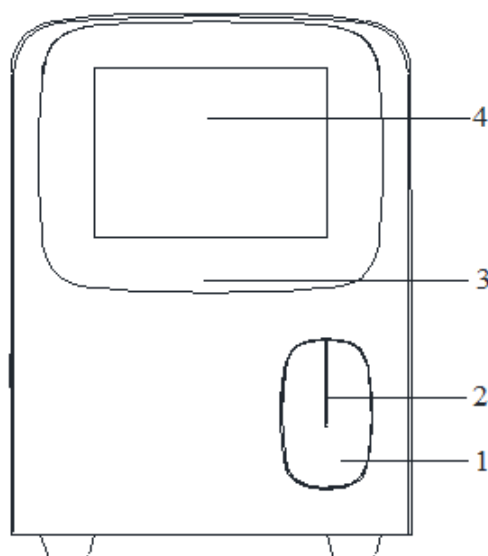

- 1: Touch screen
- 2: Power/Status indicator
- 3: Sample probe
- 4: Aspirate key

● Back of the analyser

Figure 3-2 Back of the analyser

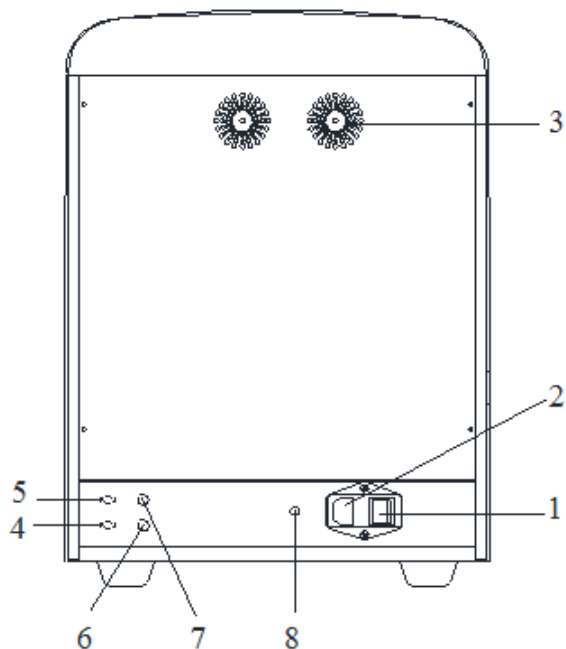

- 1: Power switch
- 2: AC input
- 3: Cooling fan
- 4: Waste outlet
- 5: Diluent inlet
- 6: Waste level detection connector
- 7: Diluent presence detection connector
- 8: Ground studs

● Side view of the analyser

Figure 3-3 Side view of the analyser

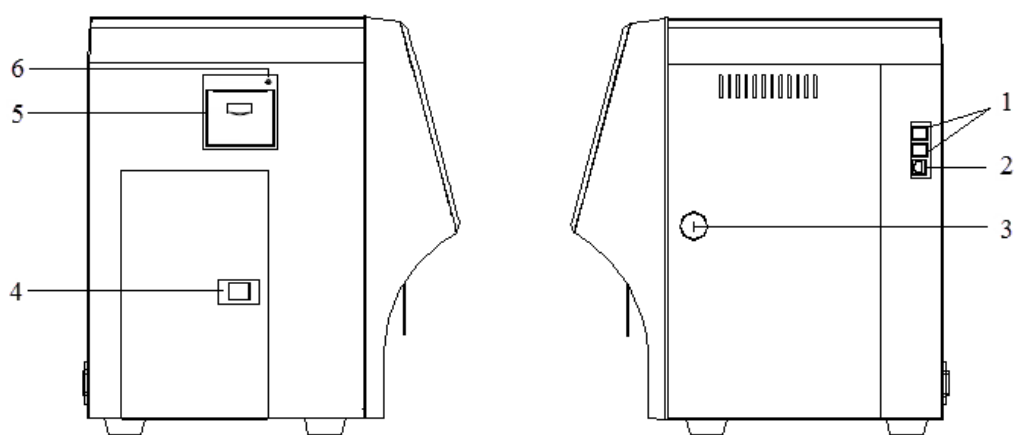

- 1: USB interface
- 2: Network interface
- 3: Right side door buckle
- 4: Left side small door buckle
- 5: Thermal printer
- 6: Paper feed key/ Printer status indicator

3.4.2 Touch screen

The touch screen is located on the front side of the analyser for performing interface operations and displaying the information.

3.4.3 Aspirate key

The aspirate key is located in the middle of the front side (behind the sample probe) to start the sample analysis, to add diluent, or to cancel sleep.

3.4.4 Power/Status indicator

The status indicator is located in the middle section of the right part of the analyser (front side). It shows the status of the analyser including ready, running, error, sleep and on/off, etc.

The indicators change with the status of the main unit. Details are shown in Table 3-1.

Table 3-1 Main Unit Status Indicators

Instrument Status	Indicator Status	Remarks
Shutdown	Off	The main unit has been shut down.
Stopped running with error conditions	Red light on	Stopped running with the occurrence of errors
Running with error conditions	Red light flickering	Running with the occurrence of errors
Time sequence deactivated	Yellow light on	Initialisation or sleep status irrelevant to running
Running	Green light flickering	Execution of the sequence actions is in process.
Ready	Green light on	Execution of the sequence actions is allowed.

NOTE

While the analyser is running, if the indicator turns dim or off, please contact Woodley Equipment Company or Woodley Equipment Company's agent for maintenance.

3.4.5 Power switch



CAUTION

To avoid damage, do not power on/off the analyser repetitively within a short time.

A power switch is located on the bottom back of the analyser. It turns on or shuts down the analyser.

3.4.6 Thermal Printer

The thermal printer is located on the left side of the analyser. It will send out the paper with records after you press the paper feed key.

3.4.7 Paper Feed Key

The paper feed key is located on the upper side of the thermal printer. After you press it, the built-in thermal printer will send out the paper with records.

3.4.8 Key for opening the paper compartment of the thermal printer

The Key for opening the paper compartment of the thermal printer is located below the touch screen. After you open it, you can change a new roll into the compartment.

3.4.9 USB interface

The USB interface is located on the right side of the main unit. There are 4 interfaces in total for external equipment (printer, barcode scanner, mouse or keyboard, and so on) connection or data transmission.

3.4.10 Network interface

The network interface is located on the right side of the main unit. There is 1 network interface in total for connecting with the Ethernet.

3.4.11 External Equipment (Optional)

The analyser can be connected with the following external equipment:

- Keyboard
The keyboard is connected with the USB interface on the right side of the analyser for controlling the analyser.
- Mouse
The mouse is connected with the USB interface on the right side of the analyser for operations on the analyser.
- Printer
The printer is connected with the USB interface on the right side of the analyser for printing reports and other information displayed on the screen.
- Barcode Scanner
The barcode scanner is connected with the USB interface on the right side of the analyser for entering barcode information in an easy and fast way.
- USB flash disk
The USB flash disk is connected with the USB interface on the right side of the analyser for exporting sample data.

3.5 User Interface

After the startup procedure, you will enter the user interface (**Sample Analysis** as default). See Figure 3-4.

Figure 3-4 User Interface

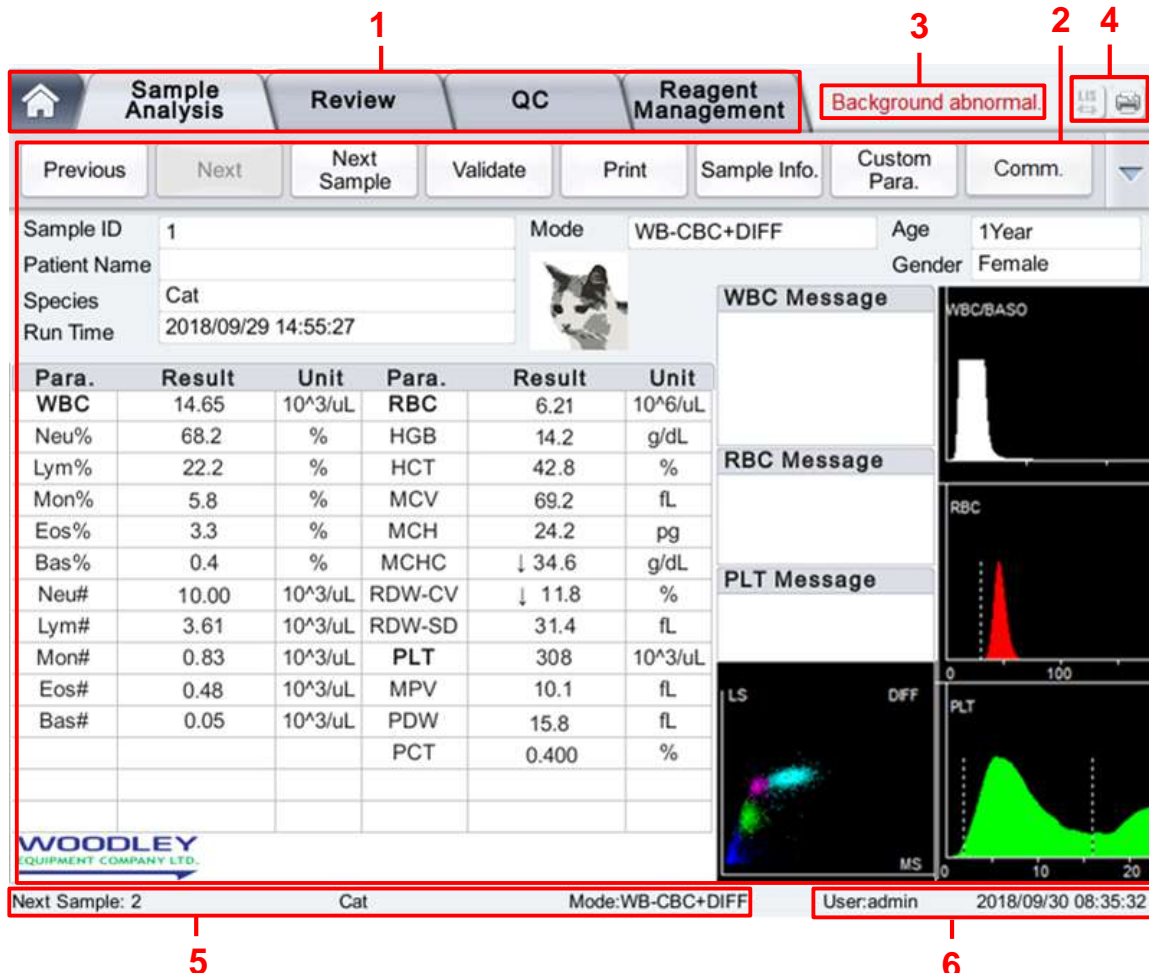





The interface can be divided into several areas as follows according to their functions:

- 1 - Menu navigation area
On the top of the screen is the menu navigation area. Once a menu button is pressed, the system goes immediately to the corresponding screen.
- 2 - Menu content display area
It displays the selected screen and the corresponding function buttons.
- 3 - Error message area
Upon the occurrence of a system failure, the corresponding error message will appear in this area. When there is more than one failure, the error message for the latest failure will appear in this area.
Click in this area, you can deal with the failures in the popup dialog box of troubleshooting help. For more information, see **13 Troubleshooting**.

- 4 - Status display area

On the top right of the screen is the status display area which shows the connection status between the analyser and the printer. The icons change with the status of the main unit, as shown in Table 3-2.

Table 3-2 Status Icon Description

Status	Icon	Remarks
LIS status	Grey icon 	The computer is not connected to the LIS.
	Colour icon 	The computer is connected to the LIS.
Print status	Grey icon 	The printer is not connected to the analyser yet.
	Colour icon 	The printer is connected to the analyser.

- 5 - Information area of the next sample and the analyser's sleep status

This area displays the information about the sample ID, counting type (species or background counting) and analysis mode of the next sample.

- 6 - Current user, date and time of the analyser.

3.6 Reagents, Controls and Calibrators

Because the analyser, reagents, controls, and calibrators are components of the system, system performance depends on the combined integrity of all the components. You should only use the Woodley Equipment Company-specified reagents (see **A.2 Reagents**), which are formulated specifically for the fluidic system of your analyser in order to achieve optimal system performance. Do not operate the analyser using reagents from other suppliers. Under such circumstances, the analyser may not achieve the performance specified in this manual and may generate unreliable results. All references to "reagents" in this manual refer to the reagents specifically formulated for this analyser.

Each reagent package should be examined before use. Inspect the package for signs of leakage or moisture. If there is evidence of leakage or improper handling, do not use the reagent.

NOTE

- After long-distance transportation, the reagent must be allowed to settle for more than one day before use.
- Store and use the reagents by following the instructions for use of the reagents.
- When you have changed the diluents or lyses, run a background check to see if the results meet the requirement.
- Pay attention to the expiration dates and open-container stability days of all the reagents. Be sure not to use expired reagents.

3.6.1 Reagents

The following reagents are intended to be used with the analyser for 5-part diff counting, daily cleaning and other operations.

- V5 DIL Diluent
This product is intended for sample dilution and preparation of cell suspension before running the samples.
- V5 LY2 Lyse
The product is intended for lysing the red blood cells and white blood cell classification.
- V5 LY1 Lyse
This product is intended for lysing the red blood cells, determining the Haemoglobin, white blood cell classification and counting the total number of white blood cells.
- V5 CLE Cleanser
This product is intended for cleaning the fluidic system of the analyser and regular instrument cleaning.

3.6.2 Controls and Calibrators

The controls and calibrators are used for quality control and analyser calibration.

The controls are commercially prepared whole-blood products used to verify that the analyser is functioning properly. They are available in low, normal, and high levels. Daily use of all levels verifies the normal operation of the analyser and ensures the acquisition of reliable results. The calibrators are commercially prepared whole-blood products used to calibrate the analyser.

Read and follow the instructions to use the controls and calibrators.

The "calibrators" and "controls" mentioned in this manual refer to Woodley Equipment Company-specified calibrators and controls and need to be purchased from Woodley Equipment Company or its specified agent.

4 Working Principle

4.1 Introduction

The measurement methods used in this analyser are: the Electrical Impedance method for determining the RBC and PLT data; the colorimetric method for determining the HGB; laser-based flow cytometry for determining the WBC data. During each analysis cycle, the sample is aspirated, diluted and mixed before the determination for each parameter is performed.

4.2 Aspiration

The analyser supports **Whole Blood** mode and **Predilute** mode.

In **Whole Blood** mode, the analyser will aspirate quantitative whole blood sample.

In **Predilute** mode, the analyser will aspirate the prediluted sample (with the dilution ratio of 1:25) which is a mixture of 20 μ L of whole blood sample and 480 μ L of diluent the diluted sample thus prepared is then delivered to the analyser for sampling and aspiration.

4.3 Dilution

After being aspirated into the analyser, the sample is divided into two parts. After the reaction with reagents in parallel dilution procedures, each part forms the sample for red blood cell/platelet, white blood cell count/haemoglobin measurement and white blood cell differential measurement.

To meet different needs, the analyser offers two working modes (Whole Blood and Predilute), and two measurement modes (CBC and CBC+DIFF).

Taking CBC+DIFF mode as an example, this section introduces the dilution procedures of the test sample in Whole Blood mode and Predilute mode separately. (The dilution procedure in CBC mode is not introduced here since it's the same as that in CBC+DIFF mode.)

NOTE

CBC mode, namely complete blood cell count, is intended for counting only, not for white blood cell classification. CBC+DIFF mode is intended for both counting and white blood cell classification.

4.3.1 Dilution Procedure in Whole-blood CBC+DIFF Mode

Dilution Procedures in Whole-Blood CBC+DIFF Mode are shown in Figure 4-1.

Figure 4-1 Dilution Procedure in Whole-blood CBC+DIFF Mode

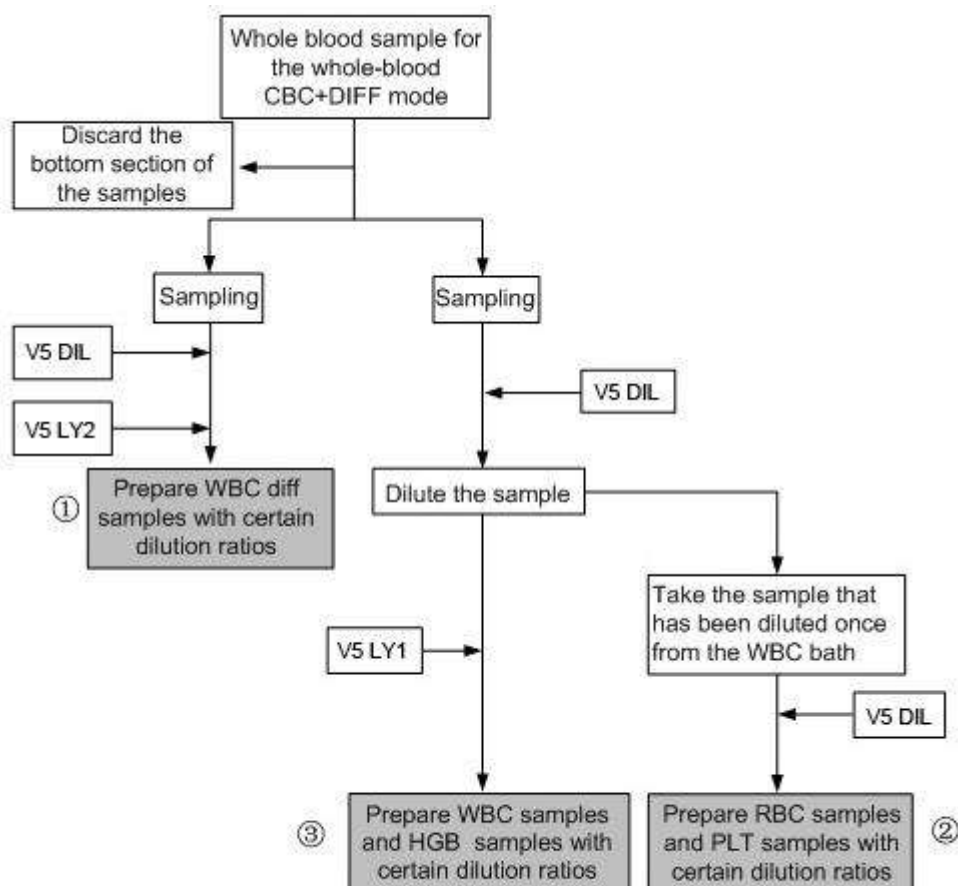

Where,

- ① is the dilution procedure for white blood cell diff, namely DIFF;
- ② is the dilution procedure for red blood cell and platelet;
- ③ is the dilution procedure for white blood cell count/Haemoglobin; namely CBC.

4.3.2 Dilution Procedure in Predilute CBC+DIFF Mode

In CBC+DIFF mode, the dilution procedure for the prediluted sample is shown in Figure 4-2.

Figure 4-2 Dilution Procedure in Predilute CBC+DIFF Mode

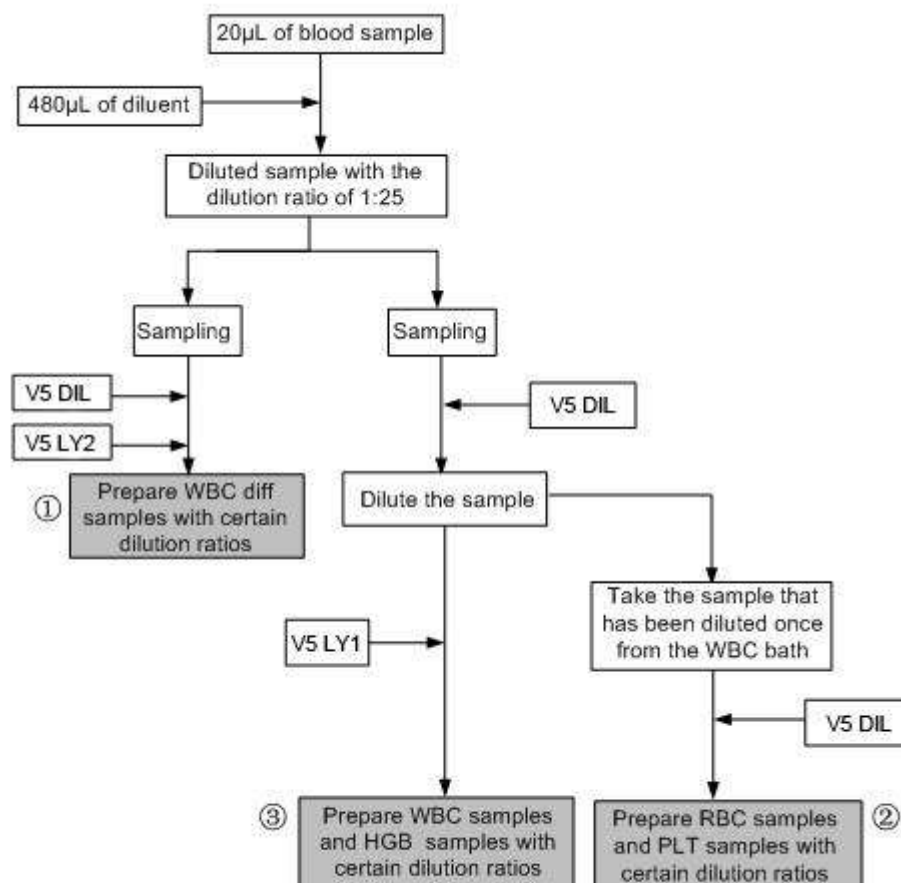

Where,

- ① is the dilution procedure for white blood cell diff, namely DIFF;
- ② is the dilution procedure for red blood cell and platelet;
- ③ is the dilution procedure for white blood cell count/Haemoglobin; namely CBC.

4.4 WBC Measurement

The analyser obtains the white blood cell 5-part classification results and white blood cell count/basophils count using a semiconductor-laser-based flow cytometry, and eventually calculates the parameters relevant to white blood cells.

4.4.1 Working Principle of Laser-based Flow Cytometry

The principle of laser-based flow cytometry is illustrated by Figure 4-3.

Figure 4-3 WBC Measurement

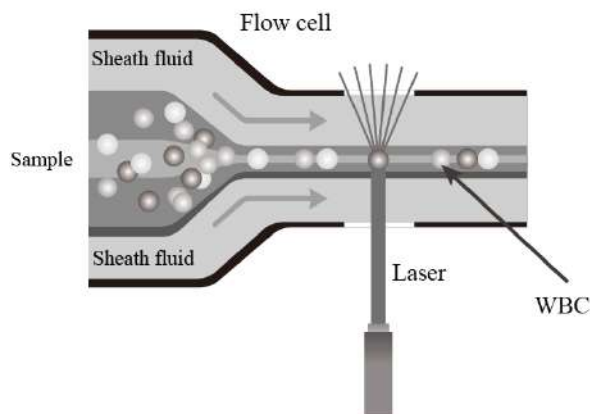

After a predetermined volume of blood is aspirated and diluted by a certain amount of reagent, it is injected into the flow chamber. Surrounded with sheath fluid (diluent), the blood cells pass through the center of the flow chamber in a single column at a faster speed. When the blood cells suspended in the diluent pass through the flow chamber, they are exposed to a laser beam. The intensity of scattered light reflects the blood cell size and intracellular density. The low-angle scattered light signal shows cell size, while the middle-angle and high-angle scattered light signal show intracellular information (nucleus and cytoplasm information). The optical detector receives this scattered signal and converts it into electrical pulses. Pulse data thus collected can be used to draw four 2-dimensional distributions (scattergrams) as shown in Figure 4-4.

Figure 4-4 DIFF channel scattergram

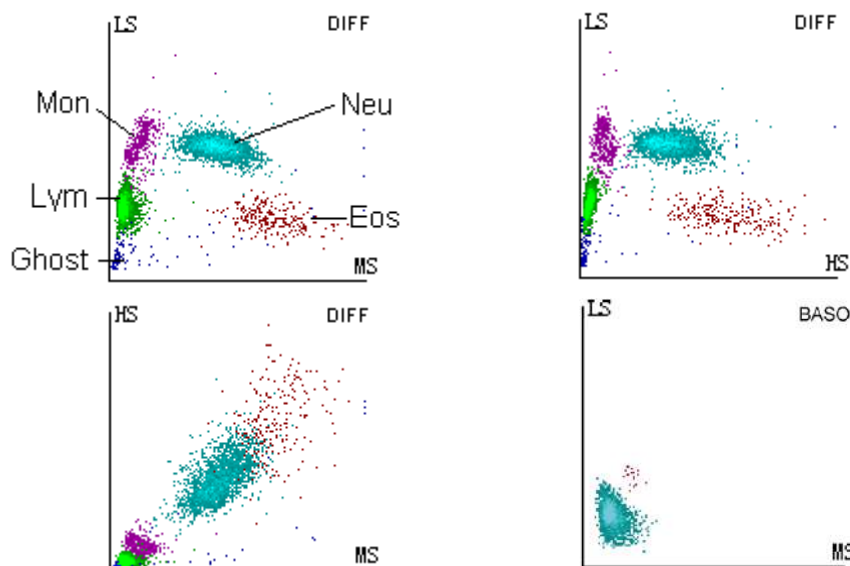

Conduct dual channel detection to the white blood cells (WBCs). Use three-angle laser scattering and flow cytometry for the count and classification of various kinds of WBCs in dual channels.

By analysing the DIFF channel scattergram, the analyser presents the Lym%, Mon%, Eos% and Neu%.

The independent WBC/Baso channel shall use a specific kind of haemolytic agent that can extract the Baso cell specificity, so as to reserve the complete information of Baso cells. Conduct precise and reliable WBC/Baso cell counting combined with three-angle laser scattering and flow cytometry.

4.4.2 Derivation of WBC-Related Parameters

Based on the DIFF scattergram and the analysis for the Lym zone, Neu zone, Mon zone and Eos zone, the analyser can get the percentage of lymphocytes (Lym%), the percentage of neutrophils (Neu%), the percentage of monocytes (Mon%) and the percentage of eosinophils (EOS%), and then get the number of basophils (Bas#), the number of lymphocytes (Lym#), the number of neutrophils (Neu#), the number of monocytes (Mon#) and the number of eosinophils (EOS#) based on the calculation with the white blood cell count obtained with the working principle of laser-based flow cytometry. The unit of the number of cells is $10^9/L$.

- White Blood Cell count

WBC count is the number of leukocytes measured directly by counting the leukocytes passing through the flow chamber.

- Number of Basophils (Bas#)

Bas# is the number of Basophils measured directly by counting the basophils passing through the flow chamber.

- Percentage of Basophils (BAS%)

$$\text{Bas\%} = \frac{\text{Bas\#}}{\text{WBC}} \times 100\%$$

- Percentage of Lymphocytes (Lym%)

$$\text{Lym\%} = \frac{\text{Particles in Lym region of DIFF channel}}{\text{Sum of all particles in DIFF channel except those in Ghost region}} \times 100\%$$

- Percentage of Neutrophils (Neu%)

$$\text{Neu\%} = \frac{\text{Particles in Neu region of DIFF channel}}{\text{Sum of all particles in DIFF channel except those in Ghost region}} \times 100\%$$

- Percentage of Monocytes (Mon%)

$$\text{Mon\%} = \frac{\text{Particles in Mon region of DIFF channel}}{\text{Sum of all particles in DIFF channel except those in Ghost region}} \times 100\%$$

- Percentage of Eosinophils (EOS%)

$$\text{Eos\%} = \frac{\text{Particles in Eos region of DIFF channel}}{\text{Sum of all particles in DIFF channel except those in Ghost region}} \times 100\%$$

- Number of Lymphocytes (Lym#)

$$\text{Lym\#} = \text{WBC} \times \text{Lym\%}$$

- Number of Neutrophils (Neu#)

$$\text{Neu\#} = \text{WBC} \times \text{Neu\%}$$

- Number of Monocytes (Mon#)

$$\text{Mon\#} = \text{WBC} \times \text{Mon\%}$$

- Number of Eosinophils (EOS#)

$$\text{Eos\#} = \text{WBC} \times \text{Eos\%}$$

4.5 HGB Measurement

HGB is determined by the colorimetric method.

4.5.1 Colorimetric Method

The WBC/HGB diluent is delivered to the HGB bath where it is mixed with a certain amount of lyse, which converts haemoglobin to a haemoglobin complex that is measurable at 525 nm. An LED is mounted on one side of the bath and emits a beam of monochromatic light with a central wavelength of 525 nm. The light passes through the sample and is then measured by an optical sensor mounted on the opposite side. The signal is then amplified and the voltage is measured and compared with the blank reference reading (readings taken when there is only diluent in the bath).

4.5.2 HGB

The HGB is calculated using the following equation and expressed in g/L.

$$\text{HGB(g/L)} = \text{Constant} \times \text{Ln} \left(\frac{\text{Blank Photocurrent}}{\text{Sample Photocurrent}} \right)$$

4.6 RBC/PLT Measurement

The analyser detects the red blood cell count and platelet count and their volume distribution by impedance method and eventually obtains the results of related parameters.

4.6.1 Electrical Impedance Method

RBCs/PLTs are counted and sized by the Electrical Impedance method. This method is based on the measurement of changes in electrical resistance produced by a particle, which in this case is a blood cell, suspended in a conductive diluent as it passes through an aperture of known dimensions. See Figure 4-5. An electrode is submerged in the liquid on both sides of the aperture to create an electrical pathway. As each particle passes through the aperture, a transitory change in the resistance between the electrodes is produced. This change produces a measurable electrical pulse. The number of pulses thus generated is equal to the number of particles that passed through the aperture.

Figure 4-5 Electrical Impedance method

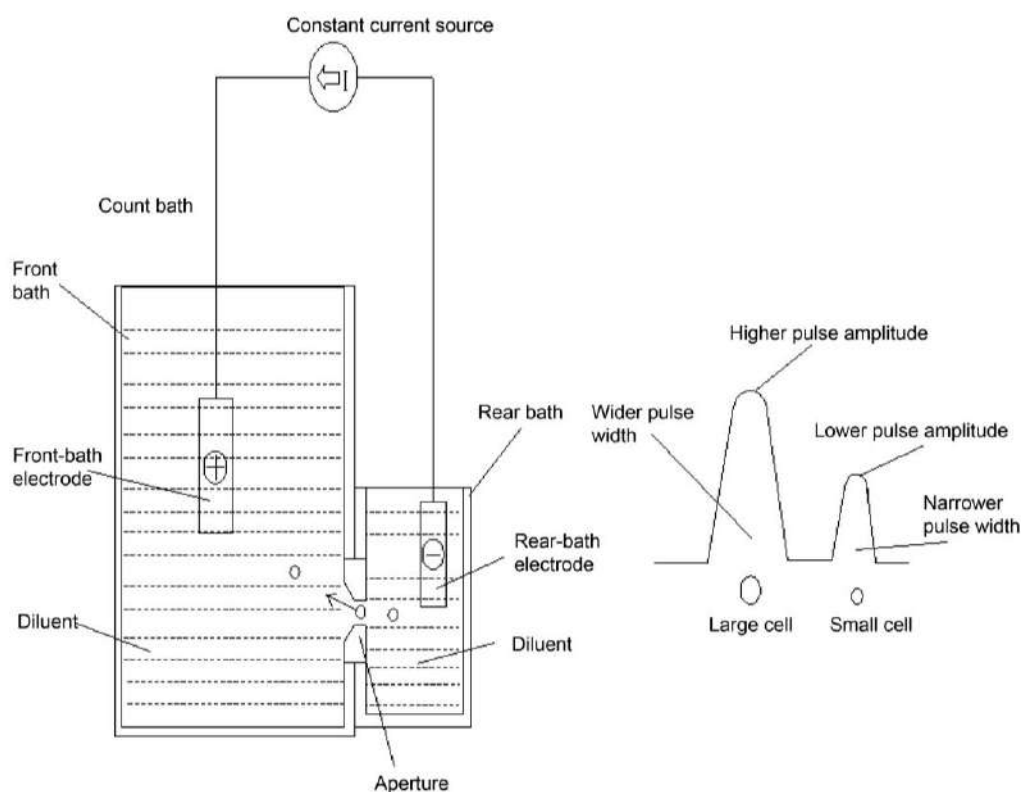

Each pulse is amplified and compared to the internal reference voltage channel, which only accepts the pulses of a certain amplitude. If the pulse generated is above the WBC/BAS lower threshold value, it is counted as a WBC/BAS. The analyser presents the RBC/PLT histogram, where the x-coordinate represents the cell volume (fL) and the y-coordinate represents the number of the cells.

4.6.2 RBC

- Red Blood Cell count

RBC ($10^{12}/L$) is the number of erythrocytes measured directly by counting the erythrocytes passing through the aperture.

- Mean Corpuscular Volume (MCV)

Based on the RBC histogram, this analyser calculates the MCV and expresses the result in fL.

- Haematocrit (HCT), Mean Corpuscular Haemoglobin (MCH), Mean Corpuscular Haemoglobin Concentration (MCHC)

This analyser calculates the HCT (%), MCH (pg) and MCHC (g/L) as follows, where the RBC is expressed in $10^{12}/L$, MCV in fL and HGB in g/L.

$$HCT = \frac{RBC \times MCV}{10}$$

$$MCH = \frac{HGB}{RBC}$$

$$MCHC = \frac{HGB}{HCT} \times 100$$

- Red Blood Cell Distribution Width - Coefficient of Variation (RDW-CV)
Based on the RBC histogram, this analyser calculates the CV (Coefficient of Variation, %) of the erythrocyte distribution width.
- Red Blood Cell Distribution Width - Standard Deviation (RDW-SD)
RDW-SD (RBC Distribution Width – Standard Deviation, fL) is obtained by calculating the standard deviation of the red blood cell size distribution.

4.6.3 PLT

- Platelet count
PLT is measured directly by counting the platelets passing through the aperture.
- Mean Platelet Volume (MPV, fL)
Based on the PLT histogram, this analyser calculates the MPV.
- Platelet Distribution Width (PDW, fL)
PDW is the geometric standard deviation (GSD) of the platelet size distribution. Each PDW result is derived from the platelet histogram data and is reported as 10(GSD).
- Plateletcrit (PCT)
This analyser calculates the PCT as follows and expresses it in %, where the PLT is expressed in 10⁹/L and the MPV in fL.

$$PCT = \frac{PLT \times MPV}{10000}$$

4.7 Flushing

After each analysis cycle, each component of the analyser is flushed.

5 Setup

5.1 Introduction

The analyser has been initialised before delivery. The interfaces upon the initial startup of the analyser are system settings by default. Some parameters of the analyser can be reset to meet various demands in practical applications.

The analyser divides the operators into two access levels, common user and administrator. Note that an administrator can access all the functions accessible to a common user. This chapter introduces how to Customise your analyser as an administrator.

5.2 Interface Introduction

After logging in the system (see **6.3 Startup**), click , and choose **Setup** to access the **Setup** interface. See Figure 5-1.

Figure 5-1 Setup



The administrator is allowed to set the following functions in the **Setup** interface:

- System settings
- Parameter settings
- Meterage settings
- Communication settings

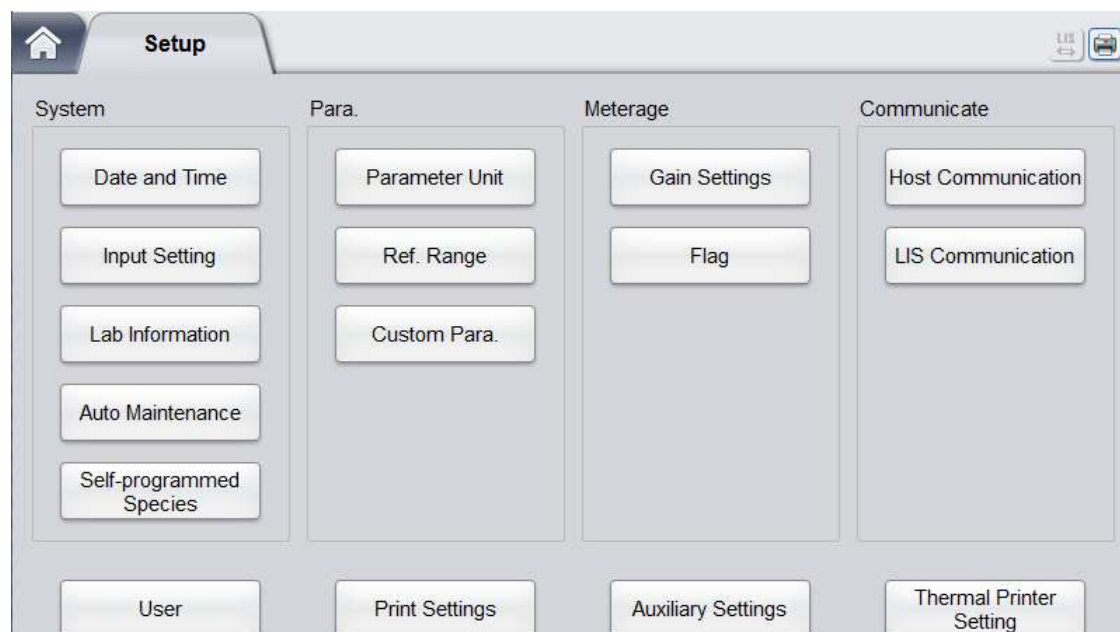
- User management
- Print settings
- Auxiliary settings
- Thermal Printer Setting

5.3 System Settings

5.3.1 Date and Time

You can set the current date and time, as well as the date display format in the analyser system. Specific steps are shown below:

1. Click **Date and Time** in the **System** area.

The date and time format setting interface pops up.

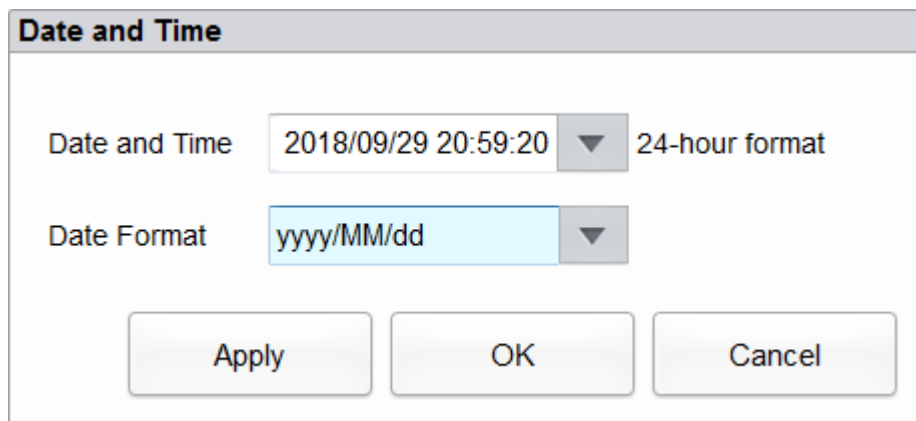



The screenshot shows a dialog box titled "Date and Time". It contains two rows of settings. The first row is labeled "Date and Time" and shows a text input field with the value "2018/09/29 20:59:20" and a dropdown arrow to its right, with the text "24-hour format" to the right of the dropdown. The second row is labeled "Date Format" and shows a text input field with the value "yyyy/MM/dd" and a dropdown arrow to its right. At the bottom of the dialog box, there are three buttons: "Apply", "OK", and "Cancel".

2. Click the **Date and Time** dropdown list and set the current date and time of the system in the popup dialog box.



The screenshot shows a date and time selection popup dialog box. It features a yellow pushpin icon in the top left corner. The title "yyyy/MM/dd HH:mm:ss" is displayed in the top right. The main area contains six columns of spinners, each with an up arrow on top and a down arrow on bottom. The values in the spinners are: 2018, 09, 29, 20, 59, and 20. At the bottom of the dialog box, there are two buttons: "OK" and "Cancel".

Related descriptions:

- The input sequence of the controls is the same with the date format on the top right corner of the dialog box. For example, if the data format is **yyyy/MM/dd HH:mm:ss**, you should input the data in the sequence of year, month, date, hour, minute, and second.
 - Click  or  to select a date and time or enter the information in the textbox directly.
 - Click  to clear the current data and re-enter the information.
3. Click **OK** to save and close the message box.
 4. Select the format setting from the dropdown list of the **Date Format**.

See Figure 5-2.

Figure 5-2 Setting the Date Format

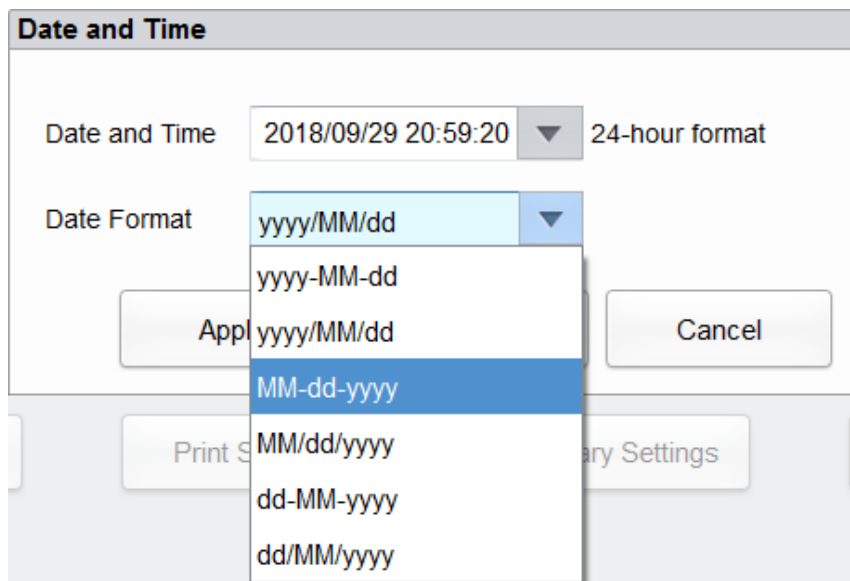

5. Click **Apply**.

The system message will pop up, indicating the successful setting. See Figure 5-3.

Figure 5-3 Successful Setting of the Date Format



The date and time at the bottom right corner will be displayed in the newly set format as shown in **09-29-2018 21:02:32**.

6. Click **OK** to close the message box.
7. Click **OK** to exit.

5.3.2 Input Settings

Click **Input Settings** in the **System** area, and then you can set the soft keyboard for screen input.

Figure 5-4 Input Settings



As shown in Figure 5-4, You can set to turn the soft keyboard on or off.

- Soft Keyboard
 - On (default)
 - You can enter content using the soft keyboard on the screen. Functions and applications for the keys are shown in Figure 5-5.

Figure 5-5 Soft Keyboard

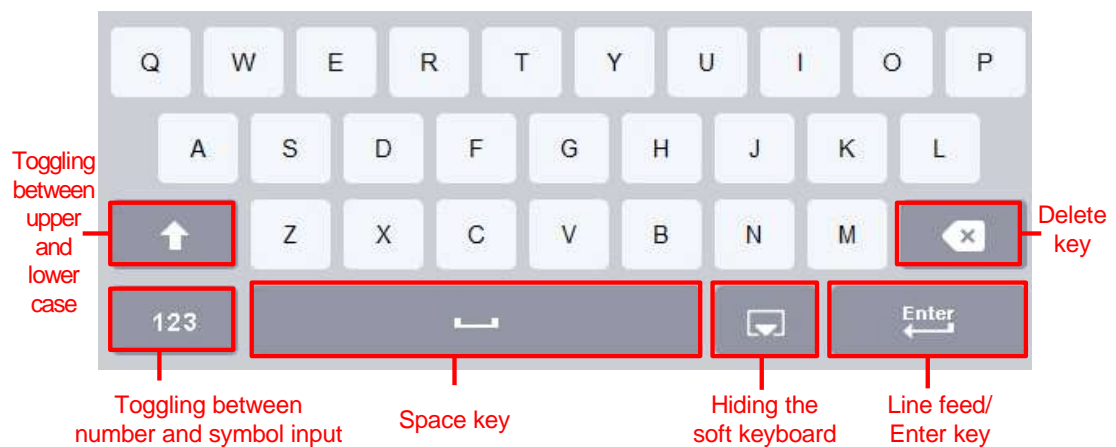

- Off
 - You need to use an externally connected USB keyboard for entering content.

5.3.3 Lab Information

Click **Lab Information** in the **System** selection, then you can set the lab information. See Figure 5-6.

Figure 5-6 Setting Lab Information

Lab Information

Hospital Name

Lab Name

Responsible Person

Responsible Person Contact Info

Customer Service Contact

Customer Service Contact Info

Analyzer SN

Installation Date
 ▼

Remarks

Apply OK Cancel

NOTE

Only the administrator has the access for setting the lab information. General users are only allowed to browse such information.

Refer to the table below for the detailed instructions of parameter setting.

Table 5-1 Setting Lab Information

Parameter	Setting Description
Hospital Name	Enter the name of the hospital where the lab is located.
Lab Name	Enter the lab name.
Responsible Person	Enter the responsible person of the lab.
Responsible Person Contact Information	Enter the contact information (telephone number or E-Mail) of the lab.
Customer Service Contact	Enter the name of the contact person in Service Department.
Customer Service Contact Informatio	Enter the contact information of the contact person in the Service Department.
Analyser SN	Display the serial number of the analyser. Read only.
Installation Date	Display the installation date of the analyser. Read only.
Remarks	Enter the remarks regarding the lab.

5.3.4 Auto Maintenance

Click **Auto Maintenance** in the **System** selection to access the **Auto Maintenance** setting interface. The system auto sleep waiting time and cleanser maintenance time can be set in the **Auto Maintenance** interface.

Figure 5-7 Auto Maintenance

Auto Sleep

In the **Wait** textbox, administrators can set a waiting time for entering the sleep state after the main unit is halted. The range is between 15 and 240 minutes and the default value is 60 minutes.

Auto Cleanser Soak

- Start Time

The administrator is allowed to set the start time of the cleanser soak in the **Start Time** textbox. The acceptable value ranges from 0:00 to 23:59 and the default value is **17:00**.

- Wait

In the **Wait** text box, administrators can set a time interval to remind the user to perform the cleanser soak. When the system reminds the user to perform cleanser, but the user cancels the operation, the system will remind again after the set waiting time. The range is between 1 and 30 minutes and the default value is **10 minutes**.

5.3.5 Self-programmed Species

If the built-in species does not meet the actual requirement, you can customise a proper species and set the parameters to be shown for the sample analysis results. You can also delete the self-programmed species that is no longer needed.

5.3.5.1 Accessing the Interface

Click **Self-programmed Species** in the **System** selection to access the Customised species setting interface. See Figure 5-8.

Figure 5-8 Self-programmed Species

Self-programmed Species	Belong to

New Delete

Refer to Table 5-2 for related parameter descriptions.

Table 5-2 Description of Self-programmed Species Parameters

Parameter	Meaning	Operation
Self-programmed Species	Species added by user. NOTE The self-programmed species must be a breed of a currently supported species. For example, the Husky , which is a self-programmed species can be set, belongs to Dog . But the Duck cannot be set as it is not supported by the system.	Enter into the textbox directly. For example, Husky .
Belong to	The source species to which the animal species belongs, such as Dog, Cat, Horse, Rabbit, Cow, Sheep, *Mouse, *Rat, *Guinea pig, *Pig and so on.	Select from the dropdown list. For example, if the animal species is Husky , which belongs to dog, you should select Dog from the dropdown list.

5.3.5.2 Adding a Species

If the built-in species does not meet the actual requirement, you can add a species.

NOTE

- Up to 20 self-programmed species can be added.
- The option with an "*" in the dropdown list of **Belong to** is the research species. Specific research species shall be subject to the actual configuration of the analyser.

1. Click **New** in the **Self-programmed Species** interface to enter the interface as shown in Figure 5-9.

Figure 5-9 Adding a Species

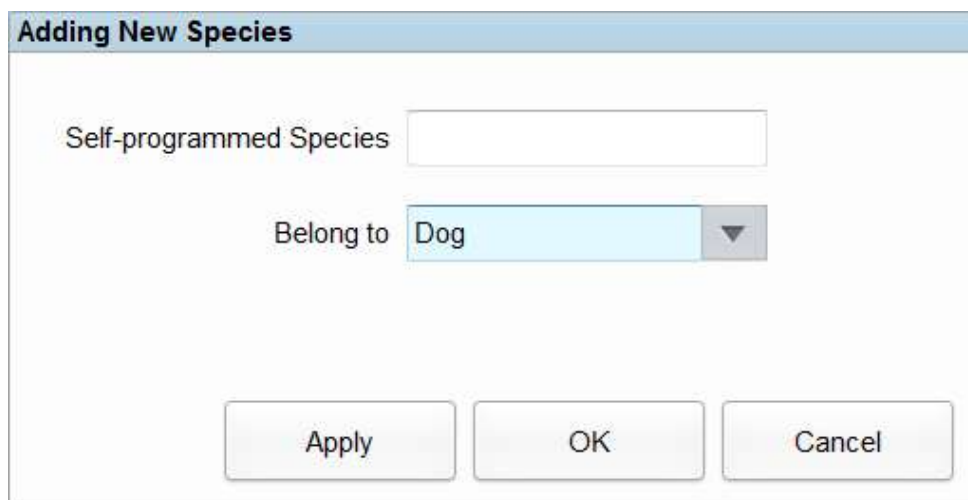

2. Enter the name of the new species and select the source species. Refer to Table 5-2 for related parameter descriptions.
3. Click **Apply** to save, or click **OK** to save and exit.

5.3.5.3 Deleting a Species

You can delete self-programmed species as required.

NOTE

When you delete the species, the sample analysis for the species will be cancelled. But you can still check the saved records of the species in the **Review** or **Sample Analysis** interface.

1. Select the species you want to delete in the **Self-programmed Species** interface, and then click **Delete**.

A pop-up dialog box appears as shown in Figure 5-10.

Figure 5-10 Deleting a Species



2. Click **Yes**.

5.4 Parameter Settings

5.4.1 Parameter Unit

Some of the parameters of the analyser can use different units which can be chosen as per user demand.

5.4.1.1 Accessing the Interface

Click **Parameter Unit** in the **Para.** selection to access the **Parameter Unit** setting interface. See Figure 5-11.

Figure 5-11 Setting Parameter Unit

Para.	Unit	Data Format
WBC	10 ³ /uL	*** **
Neu%	%	** *
Lym%	%	** *
Mon%	%	** *
Eos%	%	** *
Bas%	%	** *
Neu#	10 ³ /uL	*** **
Lym#	10 ³ /uL	*** **
Mon#	10 ³ /uL	*** **
Eos#	10 ³ /uL	*** **
Bas#	10 ³ /uL	*** **
RBC	10 ⁶ /uL	** **
HGB	g/dL	** *
HCT	%	** *
MCV	fL	*** *
MCH	pg	*** *

Select unit system:
USA ▼

Unit Options:
10³/uL

Default
Apply
OK
Cancel

5.4.1.2 Selecting Unit System

Click the **Select unit system** dropdown list and select a unit system for the parameters among the 7 unit systems (**Custom**, **China**, **International**, **UK**, **Canada**, **USA** and **Netherlands**). The default unit system is **USA**.

NOTE

- When selecting different unit standards, the corresponding unit list and unit option will be displayed differently.
- If another option is selected other than **Custom**, then the unit of each parameter can only be browsed.

5.4.1.3 Customising Parameter Unit

1. Select **Custom** from the dropdown list of **Select unit system**.

Select unit system:

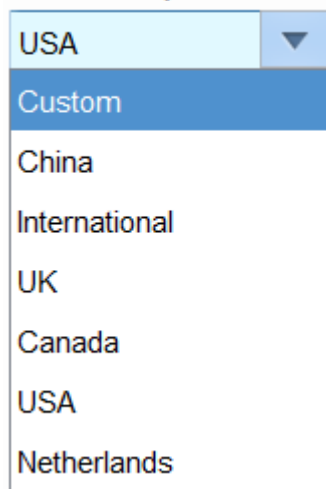

2. Click the parameter, of which the unit is to be set, from the parameter list (such as WBC).
3. Select a new parameter unit from the **Unit Options** list.

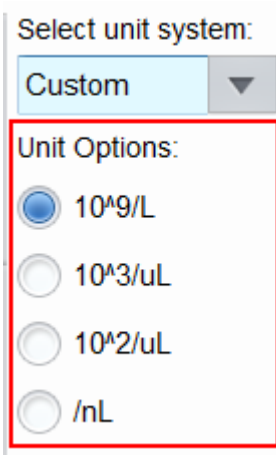

4. Click **Apply** or **OK** to save the configuration.

NOTE

- For parameters in the same group, if the unit of any parameter changes, the units of the other parameters change accordingly. (In the list, parameters will be sorted by group; the first parameter will be displayed in black and the other parameters in the same group will be displayed in grey.)
- If the parameters units change, the display format of the list data will change accordingly.

5.4.1.4 Retrieving Defaults

When setting the **Custom** unit system, if you click **Default**, the unit of the parameters can be restored to the initial default values.

5.4.2 Ref. Range

The reference range based on various normal groups can be set for the analyser in the actual practice. If the analysis result of a sample is beyond the reference range, it will be regarded as clinically abnormal. The **Ref. Range** interface is where you view and set the high and low limits for your patients. The analyser flags any parameter value above (↑) or below (↓) these limits.

The analyser divides the patients into 10 built-in groups: **Dog, Cat, Horse, Rabbit, Cow, Sheep, *Mouse, *Rat, *Guinea pig** and ***Pig**. If the built-in reference groups cannot meet the actual requirements, you can add new ones. The recommended limits are for reference only. To avoid misleading parameter flags, be sure to set the patient limits according to the characteristics of local population.

NOTE

The option with an "*" in the dropdown list of **Species** is the research species. Specific research species shall be subject to the actual configuration of the analyser.

5.4.2.1 Accessing the Interface

Click **Ref. Range** in the **Para.** selection to access the reference group settings interface. See Figure 5-12.

Figure 5-12 Ref. Range

Ref. Range							
Para.	Lower Limit	Upper Limit	Unit	Para.	Lower Limit	Upper Limit	Unit
WBC	6.00	17.00	10 ³ /uL	RBC	5.10	8.50	10 ⁶ /uL
Neu%	52.0	81.0	%	HGB	11.0	19.0	g/dL
Lym%	12.0	33.0	%	HCT	33.0	56.0	%
Mon%	2.0	13.0	%	MCV	60.0	76.0	fL
Eos%	0.5	10.0	%	MCH	20.0	27.0	pg
Bas%	0.0	1.3	%	MCHC	30.0	38.0	g/dL
Neu#	3.62	12.30	10 ³ /uL	RDW-CV	12.5	17.2	%
Lym#	0.83	4.91	10 ³ /uL	RDW-SD	33.2	46.3	fL
Mon#	0.14	1.97	10 ³ /uL	PLT	117	490	10 ³ /uL
Eos#	0.04	1.62	10 ³ /uL	MPV	8.0	14.1	fL
Bas#	0.00	0.12	10 ³ /uL	PDW	12.0	17.5	fL
				PCT	0.090	0.580	%

Species
Dog ▼

Ref. Group
Dog Default ▼

New

Edit

Delete

Close

5.4.2.2 Adding a New Ref. Group

If the built-in reference groups cannot meet the actual demand, you can add new ones and set the reference ranges for each parameter.

NOTE

- Up to 10 customised species can be added per species.
- The option with an "*" in the dropdown list of **Species** is the research species. Specific research species shall be subject to the actual configuration of the analyser.

The procedures are shown as below:

1. Select the animal type from the dropdown list of the **Species**.
2. Click **New**, and a screen for adding a new reference group will pop up. See Figure 5-13.

Figure 5-13 Adding a New Ref. Group

Ref. Group							
Para.	Lower Limit	Upper Limit	Unit	Para.	Lower Limit	Upper Limit	Unit
WBC	6.00	17.00	10 ³ /uL	RBC	5.10	8.50	10 ⁶ /uL
Neu%	52.0	81.0	%	HGB	11.0	19.0	g/dL
Lym%	12.0	33.0	%	HCT	33.0	56.0	%
Mon%	2.0	13.0	%	MCV	60.0	76.0	fL
Eos%	0.5	10.0	%	MCH	20.0	27.0	pg
Bas%	0.0	1.3	%	MCHC	30.0	38.0	g/dL
Neu#	3.62	12.30	10 ³ /uL	RDW-CV	12.5	17.2	%
Lym#	0.83	4.91	10 ³ /uL	RDW-SD	33.2	46.3	fL
Mon#	0.14	1.97	10 ³ /uL	PLT	117	490	10 ³ /uL
Eos#	0.04	1.62	10 ³ /uL	MPV	8.0	14.1	fL
Bas#	0.00	0.12	10 ³ /uL	PDW	12.0	17.5	fL
				PCT	0.090	0.580	%

Species
Dog ▼

Ref. Group Name
Custom1

Save

Close

3. Complete the entries for each parameter with reference to the parameter description in Table 5-3.

Table 5-3 Description of Ref. Group parameters

Parameter	Meanings	Operation
Ref. Group Name	Name of the new reference group.	<p>Click the edit box and enter the information using the soft keyboard. English characters and numbers are allowed to be entered, while special characters are not.</p> <p>NOTE</p> <ul style="list-style-type: none"> • The Ref. Group Name is not allowed to be empty. • The reference group name for the same species can not be duplicated.

Parameter	Meanings	Operation
Lower Limit (of parameter)	Lower limit of parameters of the reference group. If the test result is lower than this value, it would be regarded as clinically abnormal.	Click the Lower Limit cell which corresponds to the parameter and enter a new value. NOTE The Lower Limit must be smaller than the Upper Limit .
Upper Limit (of parameter)	Upper limit of parameters of the reference group If the test result is higher than this value, it would be regarded as clinically abnormal.	Click the Lower Limit cell which corresponds to the parameter and enter a new value. NOTE The Upper Limit must be greater than the Lower Limit .

4. Click **Save** to save the settings.
5. Click **Close** to exit the interface.

5.4.2.3 Editing a Ref. Group

You can modify the reference range of the parameters according to actual needs.

The procedures are shown as below:

1. Select the animal type from the dropdown list of the **Species**.

NOTE

The option with an "*" in the dropdown list of **Species** is the research species. Specific research species shall be subject to the actual configuration of the analyser.

2. Select the Ref. group to be edited from the dropdown list of **Ref. Group Name**, and click **Edit** to enter the interface as shown in Figure 5-14.

Figure 5-14 Editing a Ref. Group

Para.	Lower Limit	Upper Limit	Unit	Para.	Lower Limit	Upper Limit	Unit
WBC	6.00	17.00	10 ³ /uL	RBC	5.10	8.50	10 ⁶ /uL
Neu%	52.0	81.0	%	HGB	11.0	19.0	g/dL
Lym%	12.0	33.0	%	HCT	33.0	56.0	%
Mon%	2.0	13.0	%	MCV	60.0	76.0	fL
Eos%	0.5	10.0	%	MCH	20.0	27.0	pg
Bas%	0.0	1.3	%	MCHC	30.0	38.0	g/dL
Neu#	3.62	12.30	10 ³ /uL	RDW-CV	12.5	17.2	%
Lym#	0.83	4.91	10 ³ /uL	RDW-SD	33.2	46.3	fL
Mon#	0.14	1.97	10 ³ /uL	PLT	117	490	10 ³ /uL
Eos#	0.04	1.62	10 ³ /uL	MPV	8.0	14.1	fL
Bas#	0.00	0.12	10 ³ /uL	PDW	12.0	17.5	fL
				PCT	0.090	0.580	%

Species
Dog ▼

Ref. Group Name
Dog Default

Default

Save

Close

3. Refer to Table 5-3 for the description of the parameters to finish the editing.

NOTE

- For the built-in reference group, you can modify the upper limit and lower limit of the parameters, but not the species and reference group name.
- Click **Default** to restore the setting of the selected reference group to the default value. The settings of non-built-in reference group (which is added by user) cannot be reverted to default.

4. Click **Save** to save the modification.
5. Click **Close** to exit.

5.4.2.4 Deleting a Ref. Group

If a custom reference group is no longer needed, you can delete it.

NOTE

- Built-in reference group cannot be deleted.
- The option with an "*" in the dropdown list of **Species** is the research species. Specific research species shall be subject to the actual configuration of the analyser.

1. Select the animal type from the dropdown list of the **Species**.
2. Select the reference group to be deleted from the dropdown list of the **Ref. Group**.
3. Click **Delete**.

A pop-up dialog box appears as shown in Figure 5-15.

Figure 5-15 Deleting a Reference Group

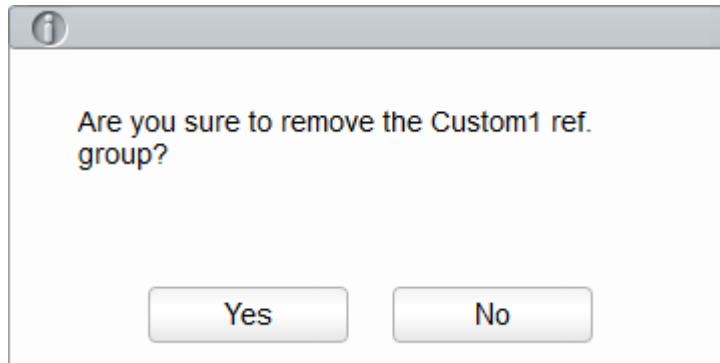

4. Click **No** ,**Yes** in the pop-up dialog box to delete the selected Customised Reference group.

5.4.3 Customised Parameters

Except for this analyser's analysis parameters, parameters collected from other testing instruments or via manual testing by the user are Customised Parameters. You can set Customised Parameters so they can be printed together with this analyser's analysis parameter details on the Haematology Analysis Report.

This analyser's default Customised Parameters include: **Blood Type**, **RH Blood Group**, **ESR**, **C-reactive Protein** and **Reticulocyte**. You can set the unit and reference range of default Customised Parameters as well as add and set Customised Parameters.

5.4.3.1 Accessing the Interface

Click **Custom Para.** in the **Para.** selection.

The Customised Parameters setting interface as shown in Figure 5-16 will pop up on the screen.

Figure 5-16 Customised Parameter Settings

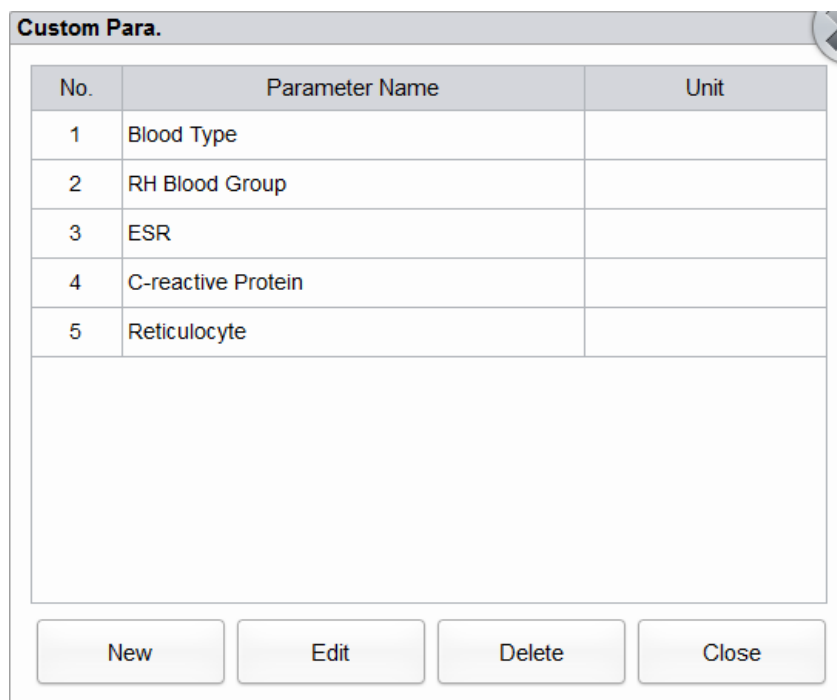

5.4.3.2 Adding a Customised Parameter

1. Click **New**. The interface as shown in Figure 5-17 will pop up on the screen.

Figure 5-17 Adding a Customised Parameter

Ref. Group	Lower Limit	Upper Limit	Parameter Name
Background			<input type="text"/>
Dog			Unit
Cat			<input type="text"/>
Horse			
Rabbit			
Cow			
Sheep			
*Mouse			
*Rat			
*Guinea pig			
*Pig			

NOTE

The reference group with "*" is the reference group of the research species. Specific research species shall be subject to the actual configuration of the analyser.

2. Click the textboxes of **Parameter Name** and **Unit** respectively, and enter the name and unit of the Customised Parameter.
3. Click corresponding cells of the **Upper Limit** and **Lower Limit** of the reference group, and input values.

You can also Customise the reference group according to the actual situation. For details, see **5.4.2 Ref. Range**.

4. Click **OK**.

The added parameter will be displayed in the Customised Parameter list.

5.4.3.3 Editing a Customised Parameter

You can set the unit and reference range of Customised Parameters. Detailed steps are shown below:

1. Select the Customised Parameter to be edited, and click **Edit**.

The interface as shown in Figure 5-18 will pop up on the screen.

Figure 5-18 Editing a Customised Parameter

Edit			
Ref. Group	Lower Limit	Upper Limit	Parameter Name
Background			Blood Type
Dog			Unit
Cat			
Horse			
Rabbit			
Cow			
Sheep			
*Mouse			
*Rat			
*Guinea pig			
*Pig			

NOTE

The reference group with "*" is the reference group of the research species. Specific research species shall be subject to the actual configuration of the analyser.

2. Click the textboxes of **Parameter Name** and **Unit** respectively, and modify the name and unit of the Customised Parameter.
3. Click corresponding cells of the **Upper Limit** and **Lower Limit** of the reference group, and modify the values.
You can also Customise the Reference Group according to the actual situation. For details, see **5.4.2 Ref. Range**.
4. Click **Save**.

5.4.3.4 Deleting a Customised Parameter

Select a Customised parameter, and click **Delete**. Then, the parameter and its corresponding reference group will be deleted.

5.5 Meterage Settings

5.5.1 Gain Settings

You can adjust each digital pot at the **Gain Settings** interface. It is not recommended to adjust gains frequently.

Click **Gain Settings** in the **Meterage** selection to access the gain setting interface. See Figure 5-19.

Figure 5-19 Gain Settings

Gain Settings

Item	Current Value	Adjustment Rate	
RBC	126	100	%
DIFF-LS	120	100	%
DIFF-MS	100	100	%
DIFF-HS	20	100	%
BASO-LS	120	100	%
BASO-MS	100	100	%
BASO-HS	20	100	%

HGB Current Value:

-
+
65

HGB Blank Voltage: 0.00 V

Apply
OK
Cancel

NOTE

New value of the gain adjustment = **Current Value** × **Adjustment Rate**.

- Setting the RBC gain
RBC channel gain.
Setting method I: click the **Current Value** of the RBC and enter the new value.
Setting method II: click the **Adjustment Rate** cell of the RBC and enter the adjustment rate of the new value relative to the current value.
- DIFF-LS, DIFF-HS, DIFF-MS
DIFF channel gain.
Setting method I: click the **Current Value** of the parameter and enter the new value.

Setting method II: click the **Adjustment Rate** cell of the parameter and enter the adjustment rate of the new value relative to the current value.

- BASO-LS, BASO-HS, BASO-MS

BASO channel gain.

Setting method I: click the **Current Value** of the parameter and enter the new value.

Setting method II: click the **Adjustment Rate** cell of the parameter and enter the adjustment rate of the new value relative to the current value.

- Setting the HGB gain

Current digital circuit gain. The purpose for adjusting the HGB channel gain is to change the HGB background voltage.

You can enter the value directly in the **HGB Current Value** textbox or click the adjusting button to adjust the HGB gain.

- Setting the HGB Blank Voltage

The background voltage derived from HGB gain cannot be modified. HGB Background Voltage can be adjusted within the specified range (4.2V~4.8V) by modifying **HGB Current Value**.

5.5.2 Flag

When the test result meets the requirement of the flag rules, the corresponding flag will be displayed on the screen. You can edit the flag rules as per the actual demand and relevant lab procedures.

Accessing the Interface

Click **Flag** in the **Meterage** selection to access the flag rules setting interface. See Figure 5-20.

Figure 5-20 Flag

Flag	Flag Rules	
Leucopenia	WBC < 3.00 (10 ³ /uL)	Species Background ▾ Edit Set as default Close
Leucocytosis	WBC > 20.00 (10 ³ /uL)	
Lymphopenia	Lym# < 0.80 (10 ³ /uL)	
Lymphocytosis	Lym# > 4.00 (10 ³ /uL)	
Neutropenia	Neu# < 1.00 (10 ³ /uL)	
Neutrophilia	Neu# > 11.00 (10 ³ /uL)	
Monocytosis	Mon# > 1.50 (10 ³ /uL)	
Eosinophilia	Eos# > 0.70 (10 ³ /uL)	
Basophilia	Bas# > 0.20 (10 ³ /uL)	
Erythrocytosis	HCT > 32.0 (%)	
Anisocytosis	RDW-CV > 22.0 (%) and RDW-SD > 64.0 (fL)	
Macrocytosis	MCV > 41.0 (fL)	
Microcytosis	MCV < 18.0 (fL)	
Anaemia	HCT < 16.0 (%)	
Hypochromia	MCHC < 29.0 (g/dL)	
Thrombocytosis	PLT > 1000 (10 ³ /uL)	
Thrombocytopenia	PLT < 100 (10 ³ /uL)	

Selecting Species

Select the species type from the dropdown list of the **Species**. The flag and flag rules for the selected species will be displayed.

NOTE

The option with an "*" in the dropdown list of **Species** is the research species. Specific research species shall be subject to the actual configuration of the analyser.

Setting Flag Rules

You can select the name of the **Flag** in the **Flag** interface, then click **Edit** to modify the rules in the popup dialog box. See Figure 5-21.

Figure 5-21 Setting Flag Rules

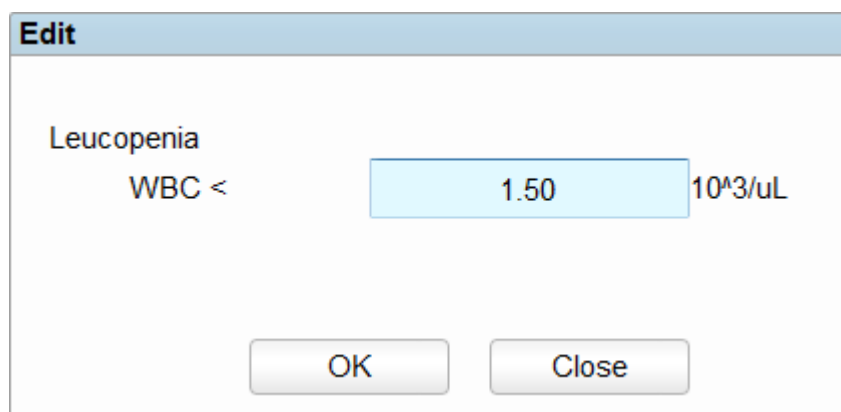

Restoring Defaults

Click **Set as default** to restore the parameter to the default value.

5.6 Communication Settings

5.6.1 Host Network Settings

On the host communication screen, you can set the network information of the analyser to enable its network connection.

Click **Host Communication** in the **Communicate** selection to access the host network setting interface. See Figure 5-22.

Figure 5-22 Host Network Settings

Host Communication

You can get IP settings assigned automatically if your network supports this capability. Otherwise, you need to ask your network administrator for the appropriate IP settings.

Obtain an IP address automatically
 Use the following address:

IP Address
 Subnet mask
 Default gateway

Obtain DNS server address automatically
 Use the following DNS server addresses:

Preferred DNS server
 Alternate DNS server

Refer to Table 5-4 for the description of relevant parameters.

Table 5-4 Description of Host Communication Setting Parameters

Parameter	It means	Operation
Obtain an IP address automatically	<p>The host gets the IP address dynamically from a DHCP server or a PPP dial-up network access server.</p> <p>This option is not applicable for the dial-up connection of SLIP server.</p>	Please choose according to the actual situation.
Use the following address:	<p>Specify the host to use the manually set IP address.</p> <p>If this option is selected, you need to set:</p> <ul style="list-style-type: none"> ● IP address The IP address obtained from the network administrator or Internet service provider. ● Subnet mask The subnet mask obtained from the network administrator or Internet service provider. ● Default gateway The IP address of the default gateway; the router's IP address for connecting the independent IP network segment. 	Obtain the IP address, subnet mask and default gateway of the host from the network administrator or Internet service provider.

Parameter	It means	Operation
Obtain DNS server address automatically	Automatically obtain the IP address of the Domain Name Server (DNS).	Please choose according to the actual situation.
Use the following DNS server addresses:	<p>Specify the IP address of the DNS server of the host.</p> <ul style="list-style-type: none"> • Preferred DNS server The IP address of preferred or primary DNS servers. • Alternate DNS server (Optional) The IP address of alternative or secondary DNS servers of the host. This server will be used if the specified IP address of the Preferred DNS server is not available or if the DNS name cannot be resolved as the IP address of the DNS server which the host has inquired. 	Obtain the IP address of DNS server from the network administrator or Internet service provider.

NOTE

You can click **Details** to check the network information of the analyser, including physical address, IP address, subnet mask, default gateway, DNS server, etc.

5.6.2 LIS Communication

In the **LIS Communication** interface, You can set the communication between the system and the LIS, including network settings, protocol settings and transmission mode.

Click **LIS Communication** in the **Communication** selection to access the Laboratory Information System (LIS) communication setting interface. See Figure 5-23.



Figure 5-23 Setting LIS Communication

Refer to Table 5-5 for the description of relevant parameters.

Table 5-5 Description of LIS Communication Setting Parameters

Parameter		Meaning	Operation
Network Settings	IP address	The IP Address of the LIS.	Please set it according to the actual situation.
	Port	The port of the LIS. The default value is 5600 .	Please set it according to the actual situation. An integer between 1025 and 65535 can be entered. NOTE If the analyser is disconnected with the LIS, click the Reconnect button to connect the LIS again.

Parameter		Meaning	Operation
Transmission Settings	Auto-communication	<p>Whether to upload the sample results automatically.</p> <ul style="list-style-type: none"> • If checked, the system will automatically upload the result to the LIS upon the completion of the analysis. • If unchecked, the result of analysis will not be automatically uploaded. <p>NOTE</p> <p>If the Bidirectional LIS/HIS Communication is checked, this parameter will be checked automatically.</p>	Please choose according to the actual situation.
	Bidirectional LIS/HIS Communication	<p>Whether to enable the bidirectional LIS/HIS communication.</p> <ul style="list-style-type: none"> • If checked, the system will automatically obtain the sample/patient information from LIS/HIS after the sample analysis is started or the patient information is edited, and automatically upload the result to the LIS upon the completion of the analysis. <p>NOTE</p> <p>If the information is matched by sample ID, you only need to enter the sample ID; if the information is matched by Med Rec.No., you only need to enter the medical record number.</p> <ul style="list-style-type: none"> • If unchecked, the software system will not obtain the sample/patient information, and decide whether to upload result based on the setting of the Auto-communication parameter. 	Please choose according to the actual situation.

Parameter		Meaning	Operation
	Bidirectional LIS/HIS Communication Timeout	<p>Timeout duration of the bidirectional LIS/HIS communication.</p> <p>The default value is 10 seconds, that is, the communication will be stopped if the software system does not connect with the LIS/HIS successfully within 10 seconds.</p> <p>NOTE</p> <p>The parameter is valid only when the Bidirectional LIS/HIS Communication is checked.</p>	<p>Directly enter in the textbox.</p> <p>Input range: an integer between 1 and 120.</p> <p>Unit: second.</p>
Protocol Settings	Communication Acknowledgement	<ul style="list-style-type: none"> • If checked, the communication between the system and the LIS is successful when the ACK response from the LIS is received within the duration of ACK timeout; no response received indicates communication failure. • If unchecked, the communication between the system and the LIS shall be considered successful no matter the ACK response from the LIS is received or not. <p>NOTE</p> <p>The system will send the next message continuously no matter the communication is successful or not.</p>	Please choose according to the actual situation.
	ACK timeout	<p>Timeout duration of the ACK response.</p> <p>The default value is 10 seconds, that is, the communication will be considered failed if the system receives no ACK response within 10 seconds.</p>	<p>Click  or  or directly input in the textbox.</p> <p>An integer between 1 and 120 can be entered.</p> <p>Unit: Second (sec.)</p> <p>NOTE</p> <p>The parameter is valid only when the Communication Acknowledgement is checked.</p>

Parameter	Meaning	Operation
Graph Format	Graph transmission format, including PNG and BMP.	Please choose according to the actual situation.
Histogram Transmission Method	<p>The methods for transmitting the histogram to the LIS when the result is transmitted by the system, including:</p> <ul style="list-style-type: none"> ● Not transmit Do not transmit the histogram to the LIS. ● Bitmap Transmit the histogram to the LIS in the format of screen display. ● Transmitting bitmap for printing The histogram is transmitted by the system to the LIS in the format of a printed report. 	Please choose according to the actual situation.
Scattergram Transmission Method	<p>The methods for transmitting the scattergram to the LIS when the result is transmitted by the system, including:</p> <ul style="list-style-type: none"> ● Not transmit Do not transmit the scattergram to the LIS. ● Bitmap Transmit the scattergram to the LIS in the format of screen display. ● Transmitting bitmap for printing The scattergram is transmitted by the system to the LIS in the format of a printed report. 	Please choose according to the actual situation.

5.7 User management

After logging into the system, the administrator has the access to set the account information of general users and other administrators; common users can only browse the user list and change their own passwords.

5.7.1 Accessing the Interface

Click **User** in the **Setup** interface to access the user management interface as shown in Figure 5-24.

Figure 5-24 User management

The screenshot shows a window titled "User" containing a table with the following data:

User Name	Name	User Group	Default User	Remarks
admin	admin	Administrator		

Below the table are several buttons: "New", "Edit", "Delete", "Set as default user", "Reset Password", "Change Password", and "Close".

5.7.2 Creating a User

Click **New** to set the account information of a new user in the popup interface, including username, first and last name, password, user group and remarks, etc. See Figure 5-25.

Figure 5-25 Creating a user

The screenshot shows a "New" popup window with the following fields:

- User Name: (Login Account)
- Name:
- Password:
- Confirm Password:
- User Group: (dropdown menu)
- Remarks:

At the bottom are "OK" and "Cancel" buttons.

NOTE

User Group includes **Common User** and **Administrator**. Users are assigned different access levels according to the user group they belong to.

Click **OK** after the setting is complete. The information of the new user will be shown in the user list.

5.7.3 Editing a User

Select the user to be edited and click **Edit** to modify the name and user group.

Figure 5-26 Editing a User

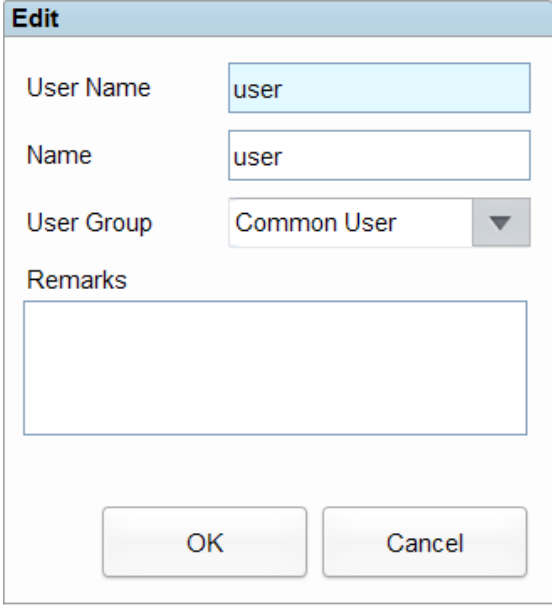

The screenshot shows a dialog box titled "Edit". It contains the following fields:

- User Name:** A text input field containing the text "user".
- Name:** A text input field containing the text "user".
- User Group:** A dropdown menu with "Common User" selected and a downward arrow.
- Remarks:** A large empty text area.

At the bottom of the dialog are two buttons: "OK" and "Cancel".

5.7.4 Deleting a User

Select the user to be deleted and click **Delete**, and then select **OK** in the pop-up dialog box to delete the user.

NOTE

The administrator cannot delete his/her own information.

5.7.5 Setting the Default User

Select a user and click **Set as default user** to set this user as the default user.

After the setting is completed, the following message box will pop up.

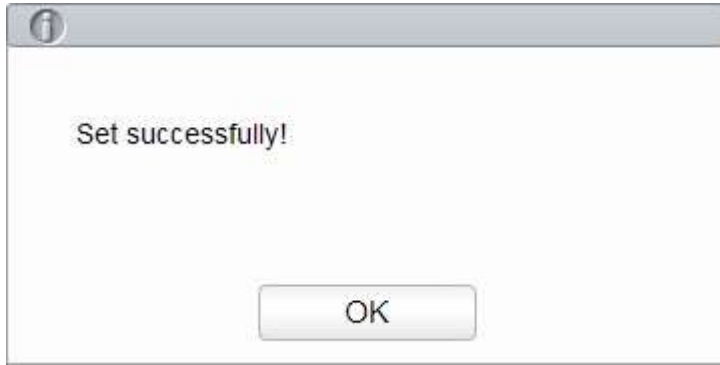

After it is set successfully, the default user name will be displayed in the login box next time and you only needs to enter the corresponding password. See Figure 5-27.

Figure 5-27 Login after Setting the Default User

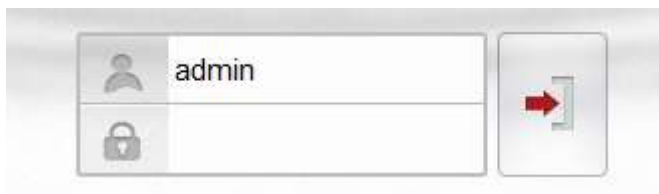

5.7.6 Changing Password

Click **Change Password**, enter the old password and new password of the user and confirm the new password in the popup dialog box, then click **OK**.

Figure 5-28 Changing Password

Change Password	
Old Password	●●●●●●
New Password	●●●●●●
Confirm New Password	●●●●●●
OK Cancel	

NOTE

You can only change his/her own password and cannot change the password of other users.

5.7.7 Resetting Password

If the user forgets the password or the password is required to be reset due to other reasons, please click **Reset Password** to reset the password of the selected user to the initial password. The reset password is the same as the user name.

NOTE

The administrator is allowed to reset the password of all administrators and general users; general users do not have the access to reset the password.

Figure 5-29 shows that the password is successfully reset.

Figure 5-29 Resetting Password

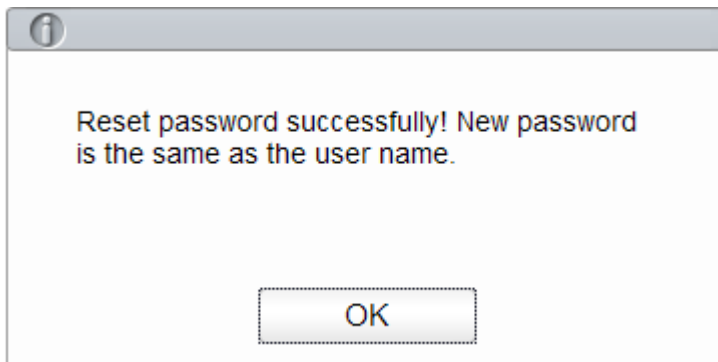

5.8 Print Settings

Click **Print Settings** in the **Setup** interface for relevant print settings, including the default printer, template, report, copies and margins, etc.

Figure 5-30 Print Settings

Printer Settings

You can set the printer and driver of the system in the **Printer** selection. See Figure 5-31.



Figure 5-31 Printer Settings

- **Printer Driver**
The system automatically detects the printer driver by default.
- **Printer**
Select a printer to be used from the dropdown list. If the dropdown list is blank, it indicates that no printer has been installed for the operating system. In this case, install a printer, and then perform the relevant settings and printing operations.
- **Printer Resolution**
Select a proper resolution from the dropdown list. The higher the resolution of the printer, the better the print quality.

Report Settings

You can set relevant parameters of the report in the **Report Settings** combo box. See Figure 5-32.

Figure 5-32 Report Print Setting

- **Report Title**
Enter the title of the report in the **Report Title** textbox. The default setting is **Haematology Analysis Report**.
- **Copies**
You can enter the number of copies to be printed for a report in the **Copies** textbox according to the actual demand. Click  to increase the number of copies and click  to decrease the number of copies or enter the number of copies in the edit box directly. Range of the copies is between 1 and 100 and the default value is 1.

Format Settings

Report type and template of prints can be set in the Format Settings combo box. See Figure 5-33.

Figure 5-33 Format Settings

- **Selecting Report Type**
Select the format type to be set from the dropdown list of the **Report Type**. The default setting is **Report**.
- **Selecting Paper Type**
Select the paper type (size) from the dropdown list of the **Paper Type**, such as **A4**. After the selection is completed, the corresponding paper size will be shown at the bottom of the list, such as **210*148 mm**.

- **Selecting Template**
Select the template to be set from the dropdown list of the **Template**.
- **Refresh**
Click **Refresh** to refresh the format list after the customisation by the administrator.
- **Importing/Exporting template**
You can export the existing template to a USB flash disk, and edit the template. After editing, import the template to the system to complete the customisation of the template.

NOTE

Before importing/exporting template, insert a USB flash disk in the USB interface on the analyser.

- **Exporting template**
Select the template to be exported from the dropdown list of **Template** and click **Export**.
Select the export path in the popup dialog box, and click **Save**.
- **Importing template**
Click **Import** and select the required template in the pop-up dialog box, then click **Open**.
- **Deleting template**
Select the template to be deleted from the dropdown list of the **Template**.

NOTE

Only customised templates can be deleted, the built-in templates cannot be deleted.

Auto Settings

- **Autoprint**
The default setting is **Off**, which means the report should be printed manually after the results are obtained.
If it is set to **On**, the system will automatically print the report of the sample as per the current report template once the counting results are obtained.

NOTE

- If Print after validation is checked, the autoprint function becomes invalid.
 - Auto print is not applicable for the background results.
-

- **Auto print after validation**
It's unchecked by default, which means the system can print the report automatically without validation.
If it's checked, the report will be printed automatically after it's been validated instead of being printed right after the results are obtained each time.
-

NOTE

The parameter is valid only when the **Autoprint** is set to **On**.

- Auto validate when printing
It's unchecked by default, which means the report will not be automatically validated by the system at the time of printing.
If it's checked, the report will be automatically validated and printed by the system at the time of printing.
- Print after validation
It's unchecked by default, which means the report can be printed without validation.
If it's checked, the report can be printed only after validation and autoprint is unexecutable.

Printing Options

- Print Flag
It's checked by default, which means the flag information will be printed in the report. If it's not checked, it will not be printed.
- Print Ref. Range
It's checked by default, which means the reference range of the parameter will be shown in the printed report; If it's unchecked, the results alone, rather than reference range, will be shown in the printed report and the reference range will not.
- Print Suspicious Flag
It's unchecked by default, which means the suspicious flag “?” will not be shown in the printed report; if it's checked, such flag can be shown.
- Print Ref. Range Flags
It's checked by default, which means the printed report can show the ref. range flag (↑ or ↓); If it's unchecked, such a flag will not be shown.
- Print result edited flags
It's unchecked by default, which means the mark for the edited results will not be shown in the printed report.
If checked, the mark (**M** or **m**) for the edited results will be shown in the printed report if the parameters have been modified.
- Update blank test time before printing
It's unchecked by default, which means the blank test time will not be processed by the system.
If it's checked, the **Delivery Time** will be automatically updated as the **Run Time** by the system at the time of printing.
- Print as black and white (Report)

NOTE

The parameter is valid only when the **Report Type** is set to **Report**.

It's unchecked by default, which means the report will be printed according to the default settings of the printer.

If it's checked, the report will be printed as black and white.

- QC Graph Setting
As shown in Figure 5-34. You can choose the QC graph parameters to be printed as required.

The system prints all the parameter results by default. You can uncheck the parameters you don't want to print.

Figure 5-34 QC Graph Setting

QC Graph Settings

<input checked="" type="checkbox"/> WBC	<input checked="" type="checkbox"/> Bas#	<input checked="" type="checkbox"/> MPV
<input checked="" type="checkbox"/> Neu%	<input checked="" type="checkbox"/> RBC	<input checked="" type="checkbox"/> PDW
<input checked="" type="checkbox"/> Lym%	<input checked="" type="checkbox"/> HGB	<input checked="" type="checkbox"/> PCT
<input checked="" type="checkbox"/> Mon%	<input checked="" type="checkbox"/> HCT	
<input checked="" type="checkbox"/> Eos%	<input checked="" type="checkbox"/> MCV	
<input checked="" type="checkbox"/> Bas%	<input checked="" type="checkbox"/> MCH	
<input checked="" type="checkbox"/> Neu#	<input checked="" type="checkbox"/> MCHC	
<input checked="" type="checkbox"/> Lym#	<input checked="" type="checkbox"/> RDW-CV	
<input checked="" type="checkbox"/> Mon#	<input checked="" type="checkbox"/> RDW-SD	
<input checked="" type="checkbox"/> Eos#	<input checked="" type="checkbox"/> PLT	

Apply OK Cancel

NOTE

The checked parameter in the QC analysis results as a valid parameter, can be displayed in the print results.

5.9 Auxiliary Settings

Click **Auxiliary Settings** in the **Setup** interface to access the **Auxiliary Settings** interface. See Figure 5-35.

Figure 5-35 Auxiliary Settings

The administrator is allowed to set the following functions in the **Auxiliary Settings** interface:

- Sample Numbering Rules
- Startup sample ID and mode
- Predilute
- Other

Sample Numbering Rules

Set the sample ID entry rules.

- Sample ID Entry Method
 - Click the dropdown list of the **Sample ID Entry Method** and select the entry method of the sample ID from the following options.
 - Auto increment (default setting)
 - Manual entry
- Prefix Length
 - When **Auto Increment** is selected as the Sample ID entry method, you can add a prefix to a certain batch of samples for identification.
 - Enter the prefix length ranging from 0 to 24 (e.g. 2) of the sample ID in the **Prefix Length** textbox. The prefix length will be applied to all sample IDs after the setting is saved.

Startup sample ID and mode

Set the sample ID and measurement mode for the next sample after startup.

- Next Sample ID and mode after startup

The sample ID and mode set by the user will be used by the system after the next startup when the specified sample ID is entered into the textbox and the measurement mode (CBC or CBC+DIFF) is selected from the dropdown list.

NOTE

If the **Effective tomorrow** is checked, the modification of the next sample ID and mode after startup will become effective on the next day.

- Continue using the sample ID and mode before the last shutdown
If checked, the system will by default add 1 to the last sample ID analysed before shutdown as the next sample ID after startup.

Predilute

Set if you wish to see a popup dialog box when you perform the Predilute counting.

- Ask for confirmation (default setting): in the **Predilute** mode, when you press the aspirate key to start the analysis, a dialog box will pop up to remind you that the ongoing analysis is for **Predilute** counting.
- Do not ask for confirmation: the dialog box for confirming the Predilute counting will not pop up.

Other

- Show Result Edited Flags
It's unchecked by default, which means the edited results are marked with an **M** at the end, while the corresponding results with manual modifications are marked with an **m** at the end. **M** or **m** is displayed between the result data and the parameter unit by default.
If unchecked, the edited result will not be marked with an **M** or **m**.
- Automatically generate the delivery date
It is checked by default, which means you don't need to manually enter the **Delivery Time** when you modify sample information after running a sample. The operating date will be displayed in the date textbox.
If unchecked, the **Delivery Time** shall be manually entered when sample information is modified in **Sample Analysis** interface.
- Automatically generate the sampling date
It is checked by default, which means you don't need to manually enter the **Sampling Time** when you modify sample information after running a sample. The operating date will be displayed in the date textbox.
If unchecked, the **Sampling Time** shall be manually entered when sample information is modified in **Sample Analysis** interface.
- Suspicious Flag
A single character (an English letter only) can be re-entered in the textbox as a suspicious flag. The default value is ?.
- Ref. Range Flags
You can select the **Ref. Range Flags** from the dropdown list. The default high flag is ↑(or H) and the default low flag is ↓ (or L).

5.10 Thermal Printer Settings

If the printout from the thermal printer is too light or too dark, you can adjust the print density of the thermal printer to improve the print quality. To set the print density of the thermal printer take the following steps:

1. Click **Thermal Printer Setting** in the **Setup** interface.

The **Thermal Printer Setting** interface pops up shown in Figure 5-36.

Figure 5-36 Thermal Printer Setting

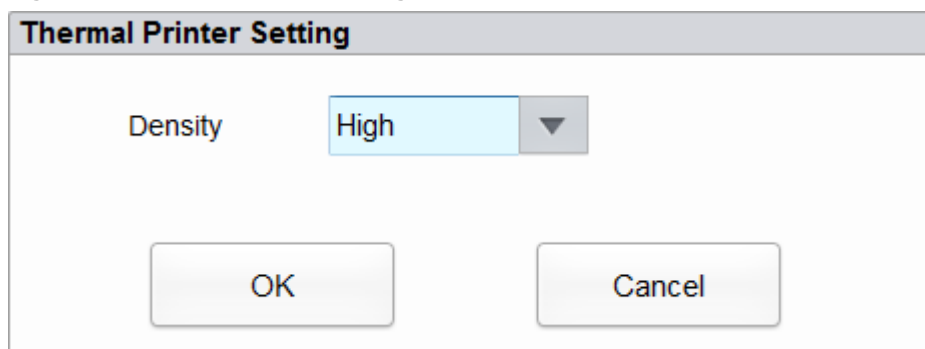

2. Select the print density from the **Density** dropdown list.
 - If the printout is too light, select **Medium** or **High** to darken the density.
 - If the printout is too dark, select **Medium** or **Low** to lighten the density.
3. Click **Apply** or **OK**.

A dialog pops up as shown in Figure 5-37.

Figure 5-37 Thermal Printer Setting Successful

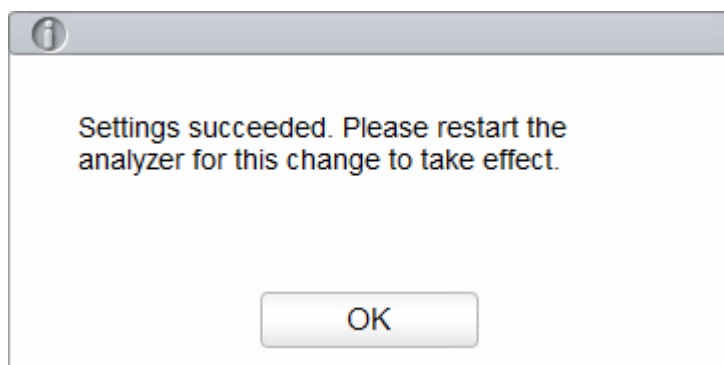

4. Restart the analyzer: turn to [O] the [O/I] switch located at the back of the analyzer; after 10 seconds approximately, turn to [I].
5. Perform a print operation to check print quality of the thermal printer.
If the problem persists, redo the above procedures until the print density meets the requirements.

6 Daily Operations

6.1 Introduction

This chapter introduces the daily operations from the startup to the shutdown of the analyser.

A flow chart indicating the common daily operation process is presented below.

Figure 6-1 Daily Operations Procedure

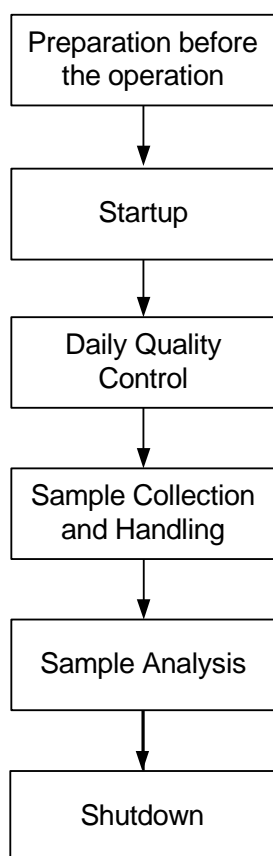

6.2 Pre-operation Preparation



All the samples, controls, calibrators, reagents, wastes and areas in contact with them are potentially biohazardous. Wear proper personal protective equipment (e.g. gloves, lab uniforms, etc.) and follow laboratory safety procedures when handling them and the relevant areas in the laboratory.

**WARNING**

- Be sure to dispose of reagents, waste, samples, consumables, etc. according to local legislations and regulations.
- Reagents can be irritating to the eyes, skin, and mucosa. Wear proper personal protective equipment (e.g. gloves, lab uniforms, etc.) and follow laboratory safety procedures when handling them in the laboratory.
- If the reagent accidentally comes in contact with your eye or skin, rinse immediately with water.
- Keep your clothes, hair and hands away from the moving parts to avoid injury.
- The sample probe tip is sharp and may contain biohazardous materials. Exercise caution to avoid contact with the probe when working around it.

NOTE

- You should only use the Woodley Equipment Company-specified reagents. Store and use the reagents as specified in instructions for use of the reagents.
- Check if the reagents are connected correctly before using the analyser.
- After long-distance transportation, the reagent must be allowed to settle for more than one day before use.
- Be sure to use clean K₂EDTA vacutainer blood collection tubes with anticoagulant, fused silica glass/plastic test tubes, centrifugal tubes and borosilicate glass capillary tubes.
- Be sure to use the Woodley Equipment Company-specified disposable products including vacutainer blood collection tube, vacutainer blood collection tubes with anticoagulant and capillary tubes etc.

Perform the following checks before turning on the analyser.

- Waste container
Check and make sure the waste container is empty.
- Fluidic tubing and power connections
Check and make sure the reagents and waste tubing are properly connected and not bent.
Check and make sure the power cord of the analyser is properly plugged into the power outlet.
- Printer (Optional)
Check and make sure enough paper is installed.
Check and make sure the power cord of the printer is properly plugged into power outlet, and the printer is properly connected to the peripheral computer.
- Network Cable (Optional)
Check and make sure the network cable is properly connected to the analyser.

6.3 Startup

This section introduces the operations related to the startup of the analyser.

NOTE

- If you failed to start the analyser continuously, please contact Woodley Equipment Company customer service department or your local agent immediately.
- After startup, please make sure the date/time displayed on the screen is correct.

1. Place the power switch at the back of the analyser in the [I] position.

The power indicator light will be on.

2. Check the indicator light on the analyser.

If the indicator light is on, it indicates the analyser has been started up. The analyser will perform self-test and initialisation in sequence. The whole process will last for 4 to 10 minutes. (Time needed for initialising the fluidic systems depends on how the analyser was previously shut down.)

3. Enter the correct user name and password in the Login message box. See Figure 6-2.

Figure 6-2 Login





The initial user name and password of administrator are **admin**, which was set by a service engineer. 1 to 12 digits of numeric characters can be entered for the user name and the password.

4. Click  to enter the user interface.

The system will display the **Sample Analysis** screen by default and display the test result of the background when the analyser is started.

NOTE

- The background test is designed for detecting particle interference and electrical interference. The sample ID for the background test is **background**.
- For the background reference range of each parameter, please see A.4.2 Normal Background.
- If the background results exceed the Ref. Range for the first time during fluidics initialisation, then the analyser will run the background test one more time.
- Running a test when there is a Background abnormal, you would obtain an unreliable testing result.
- If any error is detected during initialisation (e.g. the background results exceed the **Ref. Range**), the analyser will activate the alarm. For details, see **13 Troubleshooting**.
- To lock or switch a user, click  on the menu screen and click **Yes** on the pop-up dialog box. The system will return to the login dialog box. Enter the user name and password, click , then you can log in again or log in the software interface with another user identity.

6.4 Daily Quality Control

To ensure reliable analysis results, conduct periodic QC analysis on the analyser before running samples. For details, see **9 Quality Control**.

6.5 Sample Collection and Handling



All the samples, controls, calibrators, reagents, wastes and areas in contact with them are potentially biohazardous. Wear proper personal protective equipment (e.g. gloves, lab uniforms, etc.) and follow laboratory safety procedures when handling them and the relevant areas in the laboratory.



WARNING

Do not touch the blood sample directly.



CAUTION

- Do not re-use disposable products such as collection tubes, test tubes, capillary tubes, etc.
- Prepare the samples as per the procedures recommended by the reagent manufacturer.

NOTE

- Be sure to use clean K₂EDTA vacutainer blood collection tubes with anticoagulant, fused silica glass/plastic test tubes, centrifugal tubes and borosilicate glass capillary tubes.
- Be sure to use the Woodley Equipment Company-specified disposable products including vacutainer blood collection tube, vacutainer blood collection tubes with anticoagulant and capillary tubes etc.
- For the whole blood samples to be used for WBC classification or PLT count, store them at room temperature and run them within 8 hours after collection.
- If you do not need the PLT, MCV and WBC differential results, you can store the samples in a refrigerator (2°C - 8°C / 36°F - 46°F) for 24 hours. Samples should be kept at room temperature for at least 30 minutes before running them.
- Be sure to mix any sample that has been prepared for a while before running it.

6.5.1 Running the Whole Blood Samples

The procedure for preparing whole blood sample is as follows:

1. Use clean K₂EDTA (1.5mg/mL~2.2mg/mL) vacutainer blood collection tubes with anticoagulant to collect whole blood samples.

2. Mix the whole blood with the anticoagulant well in the tube immediately.



CAUTION

For vacutainer blood collection tube ($\Phi 12 \times 75$, cap excluded), please make sure the volume of the whole blood sample is not less than 0.5mL.

6.5.2 Prediluted Samples

The procedure for preparing prediluted sample is as follows:

1. Click the  on the top left corner and enter the menu screen as shown in Figure 6-3.

Figure 6-3 Menu Screen



2. Click the **Add Diluent** icon.

A prompt box will pop up on the screen as shown below.

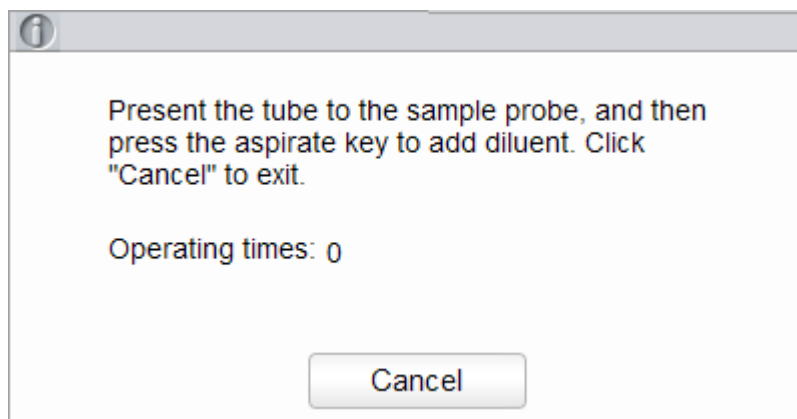

3. Take a clean centrifugal tube, uncap it and present it to the sample probe in a manner as shown in the following picture in which the probe tip is vertically in contact with the bottom of the tube so as to avoid bubbles, liquid attached to the inner wall or spatter.

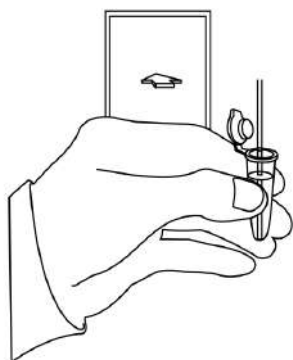

4. Press the aspirate key and add the diluent (480 μ L at a time).
After the diluent is added and you hear a beep, you can remove the centrifugal tube.
5. If more portions of diluent are needed, repeat steps 3–4.
6. Add 20 μ L of blood to the diluent, close the tube cap and shake the tube to mix the sample.
7. After the prediluted sample is prepared, click **Cancel** to exit dispensing the diluent.

NOTE

- You can also dispense 480 μ L of diluent by pipette into the tube.
 - The prediluted sample prepared after single blood collection can be counted twice.
 - Be sure to keep dust from the prepared diluent.
 - Be sure to run the prediluted samples within 30 minutes after the mixing.
 - Be sure to mix any sample that has been prepared for a while before running it.
 - Be sure to evaluate predilute stability based on your laboratory's sample population and sample collection techniques or methods.
 - The centrifugal tube shall be placed vertically upward, not tilted or upside down. Otherwise, the inner wall of the tube would be stained with excessive sample, resulting in waste. Moreover, it may cause unevenly mixed sample and unreliable analysis results.
-

6.6 Sample Analysis

After the sample is prepared, you can perform the operations for sample analysis.

For details, see **7 Sample Analysis**.

6.7 Shutdown



All the samples, controls, calibrators, reagents, wastes and areas in contact with them are potentially biohazardous. Wear proper personal protective equipment (e.g. gloves, lab uniforms, etc.) and follow laboratory safety procedures when handling them and the relevant areas in the laboratory.



WARNING

The sample probe is sharp and potentially biohazardous. Exercise caution to avoid contact with the probe when working around it.



CAUTION

Do not turn on the analyser immediately after its shutdown. Wait at least 10 seconds before power-on to avoid damage to the machine.

NOTE

- To ensure stable analyser performance and accurate analysis results, be sure to perform the Shutdown procedure at the end of every day of use.
 - When the analyser is running or performing other fluidics sequence, do not force shutdown the analyser.
 - If any error is detected during shutdown procedure, the analyser will return to the status before the shutdown procedure is performed, and then activate the alarm. See **13 Troubleshooting** for details of removing the error.
 - Be sure to shut down the analyser in strict accordance with the instruction below.
-

Procedures for shutting down the analyser are as follows:

1. Click the  button on the menu screen.

The interface pops up a dialog box as shown below.

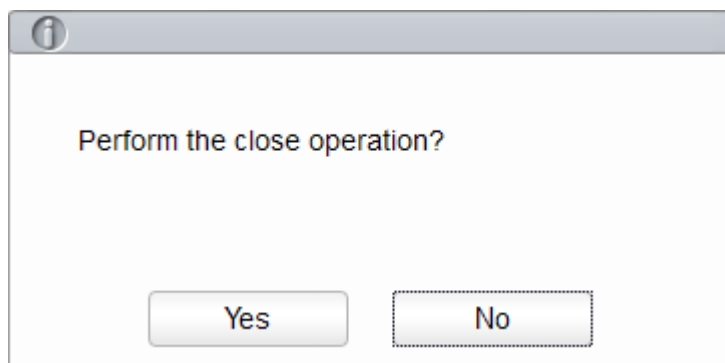

2. Click **Yes**.

The system starts to execute the shutdown sequence and a message box pops up showing the procedures for cleanser maintenance.

3. Follow the instructions and set the cleanser under the sample probe, and press the aspirate key on the analyser or click **Aspirate** to run the cleanser aspiration.

Upon the completion of cleanser maintenance, you'll be prompted that the cleanser maintenance is completed.



Shutdown done. Please power off the analyser!

4. Place the [O/I] switch at the back of the main unit in the [O] position.
5. After shutdown, empty the waste in the waste container, and dispose of it.



WARNING

Be sure to dispose of reagents, waste, samples, consumables, etc. according to local legislations and regulations.

7 Sample Analysis

7.1 Introduction

Sample analysis is the most important function of the auto haematology analyser. You can get the blood cell count, HGB concentration and the 5-part classification counting results of the white blood cells by performing the sample analysis.

The summary of sample analysis procedures are as follows:

1. Entering the sample information.
2. Running the samples.
3. Processing the analysis results.

7.2 Interface Introduction

The **Sample Analysis** interface is the main interface of the analyser (Figure 7-1). You can complete the operations such as entering the sample information, performing sample analysis, reviewing/printing analysis results in the **Sample Analysis** interface.

Figure 7-1 Sample analysis interface

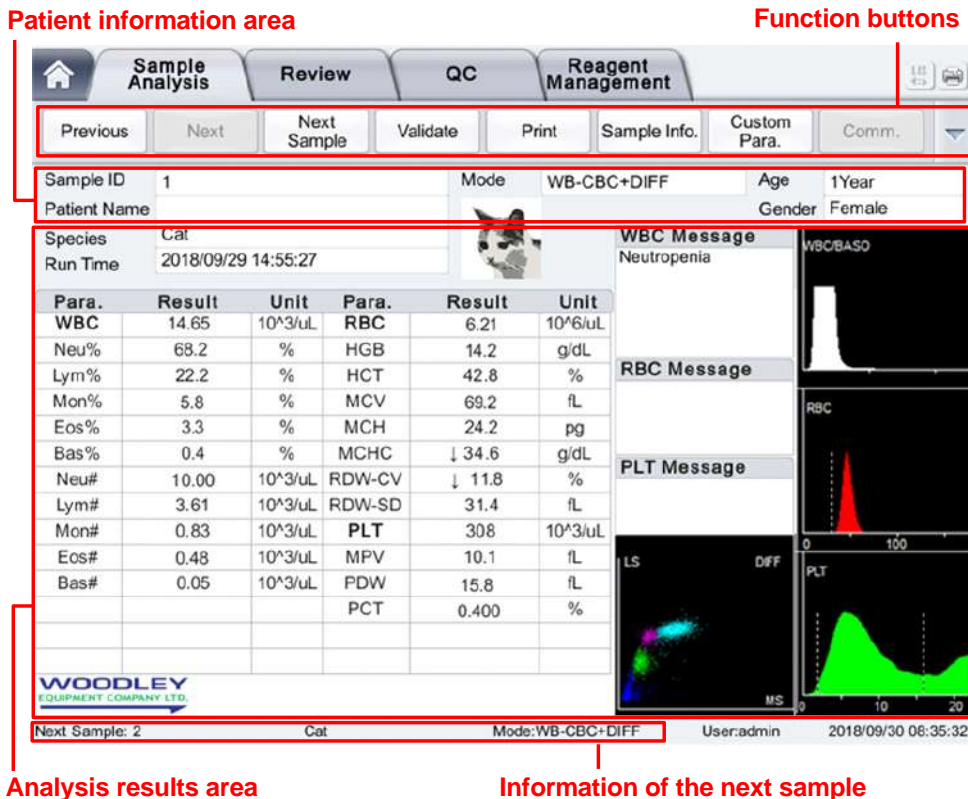

Related descriptions:

- Function buttons

You can:

- Review the previous/next records
- Set the next sample information
- Set the current sample information
- Edit, validate, print, upload, or delete sample results

For details, see section **7.6 Functions of the Buttons**.

- Sample information area

It displays the species information corresponding to the current sample.

- Analysis results area

It displays the analysis results of the sample, including the parameter results, Flags, DIFF scattergrams, BASO scattergram and histograms (including WBC, RBC and PLT). The system displays the analysis results of the most recent run by default.

- Parameter Results

This list displays the analysis results of all the parameters of the samples.

You can compare the values in the **Result** column with the corresponding **Ref. Range**. If the values are within the reference range, it means that they are normal. If not, it indicates that the sample may be abnormal and the corresponding symbols will be displayed in the **Flag** column

- WBC Message

Displays the alert message regarding the WBC.

- RBC Message

Displays the alert message regarding the RBC.

- PLT Message

Displays the alert message regarding the platelet.

- DIFF

WBC DIFF scattergram in the CBB+DIFF mode. Click the scattergram, three WBC DIFF scattergrams including LS-MS, LS-HS and HS-MS and one BASO scattergram will be displayed.

- WBC

WBC distribution histogram. You can click the histogram for an enlarged view, and click again to reinstate.

- RBC

RBC distribution histogram. You can click the histogram for an enlarged view, and click again to reinstate.

- PLT

Platelet distribution histogram. You can click the histogram for an enlarged view, and click again to reinstate.

- Information of the next sample and the analyser's sleep status.

It displays the sample ID, counting type (species or background test) and analysis mode of the next sample or the analyser's sleep status.

7.3 Entering Sample Information

Before sample analysis, you need to set the analysis mode of the sample to be run, and enter information for the sample.

NOTE

You can also enter sample information after the sample analysis is completed. For details, please refer to **7.6.5 Sample Information** or **8.4.4 Sample Info..**

Detailed steps are shown below:

1. Click the **Next Sample** button in the function button area.

The interface as shown in Figure 7-2 will pop up on the screen.

Figure 7-2 Entering Sample Information

The screenshot shows a dialog box titled "Next Sample" with the following fields and controls:







- Sample ID:** Text input field containing "3".
- Species:** Dropdown menu with "Dog" selected.
- Mode:** Two dropdown menus, the first with "Whole Blood" and the second with "CBC+DIFF".
- Ref. Group:** Dropdown menu with "Dog Default" selected.
- Patient Name:** Text input field.
- Age:** Text input field followed by a "Year" dropdown menu.
- Gender:** Dropdown menu.
- Patient ID Number:** Text input field.
- Owner Name:** Text input field.
- Veterinarian:** Text input field.
- Sampling Time:** Dropdown menu with "2018/09/29 16:49" selected.
- Delivery Time:** Dropdown menu with "2018/09/29 16:49" selected.
- Remarks:** Large text area for notes.
- Buttons:** "Apply", "OK", and "Cancel" buttons at the bottom.

2. Enter sample information with reference to the parameter description in Table 7-1.

Table 7-1 Parameter Description

Parameter	It means	Operation
Sample ID	Identification number for the samples to be run.	<p>Enter in the textbox directly.</p> <p>NOTE</p> <ul style="list-style-type: none"> • Letters, numbers and all characters that can be entered through the keyboard (including special characters) are allowed for the Sample ID. Chinese and other languages (such as Japanese, Korean, etc) are not supported. • The length of the entries ranges from 1 to 25 and the entries shall not be empty. • If the sample ID entry method is auto increment, the last character of a sample ID must be numeric, but a string of "0" only is not an acceptable sample ID. See 5.9 Auxiliary Settings for the setting of sample ID entry method. • Different samples to be run cannot have the same sample ID.
Species	<p>Animal type of sample. You can choose from the following: Background, Dog, Cat, Horse, Rabbit, Cow, Sheep, *Mouse, *Rat, *Guinea pig and *Pig.</p> <p>NOTE</p> <ul style="list-style-type: none"> • The Background is used for background test. • The option with an "*" in the dropdown list of Species is the research species. All species supported by the system are subject to the actual interface. 	Select from the dropdown list.
Ref. Group	<p>The reference group to which the species belongs. The reference group options are displayed according to the selected Species.</p> <p>The result is judged according to the reference range of the reference group and the result beyond the normal range will be flagged.</p>	<p>Select from the dropdown list.</p> <p>NOTE</p> <p>Refer to 5.4.2 Ref. Range for the settings of the reference group and range.</p>
Patient Name	Name of patient.	Enter in the textbox directly.
Age	Age of patient.	Select the age unit from the dropdown list (Year, Month, Day or Hour) and enter a number into the box next to the age unit.

Parameter	It means	Operation
Gender	Gender of patient. Including: <ul style="list-style-type: none"> • (Null) • Male • Female 	Select from the dropdown list.
Patient ID Number	ID Number of patient	Enter in the textbox directly.
Mode	Analysis mode of the sample, including blood sample and measurement mode. Among which, blood sample modes include: <ul style="list-style-type: none"> • Whole Blood • Predilute Measurement modes include: <ul style="list-style-type: none"> • CBC Complete Blood Count with no differential count for white blood cells. The counting results comprise 13 parameters, 3 histograms (including WBC, RBC and PLT), and one BASO scattergram. • CBC+DIFF Complete Blood Count plus differential count for white blood cells. The counting results comprise 23 measurement parameters, 3 DIFF scattergram, 1 BASO scattergram, and 3 histograms (including WBC, RBC and PLT). 	Select from the dropdown list.
Owner Name	Name of the patient's owner.	Enter in the textbox directly.

Parameter	It means	Operation
Sampling Time	Date and time when the sample is collected.	<p>Click the date control for the settings.</p> <ul style="list-style-type: none"> The input sequence of the controls is the same with the date format on the top right corner of the dialog box. For example, if the data format is yyyy/MM/dd HH:mm, you should input the data in the sequence of year, month, date, hour, and minute. Click  or  to select the date or click the textbox to enter them directly. Click  to clear the current data and re-enter the information. <p>NOTE</p> <ul style="list-style-type: none"> The system automatically displays the current time as sampling time. The sampling time can be no later than the current system time.
Delivery Time	Date and time when the sample is delivered.	<p>Click the date control for the settings.</p> <ul style="list-style-type: none"> The input sequence of the controls is the same with the date format on the top right corner of the dialog box. For example, if the data format is yyyy/MM/dd HH:mm, you should input the data in the sequence of year, month, date, hour, and minute. Click  or  to select the date or click the textbox to enter them directly. Click  to clear the current data and re-enter the information. <p>NOTE</p> <ul style="list-style-type: none"> The system automatically displays the current time as sample delivery time. The delivery time can be no later than the current system time and cannot be earlier than the sampling time.
Veterinarian	A physician who diagnoses and treats the patient.	Enter in the textbox directly.
Remarks	Clarifications or notes.	Input in the textbox directly.

3. Click **Apply** to save, or click **OK** to save and exit.

7.4 Running Samples



All the samples, controls, calibrators, reagents, wastes and areas in contact with them are potentially biohazardous. Wear proper personal protective equipment (e.g. gloves, lab uniforms, etc.) and follow laboratory safety procedures when handling them and the relevant areas in the laboratory.



WARNING

The sample probe tip is sharp and may contain biohazardous materials. Exercise caution to avoid contact with the probe when working around it.



CAUTION

- Do not re-use such disposable products as collection tubes, test tubes, capillary tubes, etc.
- Make sure that the entered sample ID and mode exactly match those of the samples to be run.

NOTE

- The tube (or centrifugal tube) shall be placed vertically upward, not tilted or upside down. Otherwise, the inner wall of the tube may be stained with excessive sample, resulting in waste. Moreover, it may cause unevenly mixed sample and unreliable analysis results.
- During aspiration, the tip of the probe should be kept at a certain distance from the bottom of the sample container, otherwise the accuracy of aspiration volume will be affected.
- Keep the tip of the probe from contacting with the wall of the test tube to avoid blood splashing.
- Proper reference range shall be selected on the **Setup** interface before analysis. Otherwise, the results may be flagged erroneously.
- When the analyser is running the samples, you can switch to **Review** interface to perform operations including browsing and exporting, etc., and you can also switch to other interfaces. But all the functions related to the fluidics sequence are not available.

Take the following steps to perform sample analysis.

1. Prepare samples as instructed by **6.5 Sample Collection and Handling**.
 - For details about the preparation of whole blood samples, see **6.5.1 Running the Whole Blood Samples**.
 - For details about the preparation of prediluted samples, see **6.5.2 Prediluted Samples**.
2. When the green indicator light is steady-on, click **Next Sample** in the **Sample Analysis** interface to set the sample information and analysis mode.

For detailed operations and parameter descriptions, see **7.3 Entering Sample Information**.
3. Gently mix the capped tube of sample for a homogeneous specimen.

4. Remove the tube cap carefully and place the sample under the probe so that the probe can aspirate the well-mixed sample.
5. Press the aspirate key on the analyser to start running the sample.
The sample will be automatically aspirated by the sample probe.
6. When you hear a beep, remove the sample tube.
The analyser will automatically run the sample and the analysis status icon and analyser indicator is flickering in green. When the analysis is complete, the analyser indicator returns to constantly-on green.
7. Repeat steps 1-6 to run the remaining samples.

7.5 Dealing with the Analysis Results

7.5.1 Automatic saving of analysis results

This analyser automatically saves sample results. When the maximum number 50,000 (including QC results) has been reached, the newest result will overwrite the oldest (already backed up).

7.5.2 Parameter Flags

- If parameter is followed by a “↑” or “↓”, it means the analysis result has exceeded the upper or lower limit of the reference range but still within the display range.
- If the parameter is followed by a “?”, it means the analysis result is suspicious.
- If you see “****” instead of a result, it means the result is either invalid or beyond the display range.

NOTE

For the background test, the flags for parameters or abnormal blood cell differential and morphology are not available.

7.5.3 Flags of Abnormal Blood Cell Differential or Morphology

The analyser will flag abnormal or suspicious WBC, RBC and PLT according to the scattergrams and histograms. The flag information is defined in the table below.

Table 7-2 Flags of abnormal blood cell differential or morphology

Flag Type		Flag information
WBC	Abnormal	Leucocytosis
		Leucopenia
		Neutrophilia
		Neutropenia
		Lymphocytosis

Flag Type		Flag information
		Lymphopenia
		Monocytosis
		Eosinophilia
		Basophilia
	Suspicious	WBC abnormal
		Abnor. WBC scattergram
		Abnor. WBC histogram
		Left Shift?
		Immature Cell?
		RBC Lyse Resistant?
		Abn./Atypical Lym?
		Abnormal WBC Channel
		Abnormal DIFF Channel
RBC/HGB	Abnormal	Erythrocytosis
		Anisocytosis
		Macrocytosis
		Microcytosis
		Anaemia
		Hypochromia
	Suspicious	Abnor. RBC Distr.
		Dimorphologic
		Iron Deficiency?
		HGB Abnor./Interfere?
		RBC Clump?
		Abnormal RBC Channel
		Abnormal HGB Channel
PLT	Abnormal	Thrombocytosis
		Thrombocytopenia
	Suspicious	Abnor. PLT Distr.
		PLT Clump?

The system shows flags for abnormal or suspicious items in different samples and measurement modes in accordance with the impact of the abnormal or suspicious WBC, RBC or PLT items on the results of the parameters. The correlation is shown in the following table.

Table 7-3 Flags for abnormal or suspicious items in different samples and measurement modes

Type	Flag	Whole Blood		Predilute (PD)	
		CBC	CBC+DIFF	CBC	CBC+DIFF
WBC	WBC abnormal?	√	√	√	√
	RBC Lyse Resistant?	x	√	x	√
	Abnor. WBC scattergram	x	√	x	√
	Abnor. WBC histogram	√	√	√	√
	Left Shift?	x	√	x	√
	Immature Cell?	x	√	x	√
	Abn./Atypical Lym?	x	√	x	√
	Leucocytosis	√	√	√	√
	Leucopenia	√	√	√	√
	Neutrophilia	x	√	x	√
	Neutropenia	x	√	x	√
	Lymphocytosis	x	√	x	√
	Lymphopenia	x	√	x	√
	Monocytosis	x	√	x	√
	Eosinophilia	x	√	x	√
	Basophilia	x	√	x	√
	Abnormal WBC Channel	x	√	x	√
	Abnormal DIFF Channel	x	√	x	√
RBC/HGB	Dimorphologic	√	√	√	√
	HGB Abnor./Interfere?	√	√	√	√
	Anisocytosis	√	√	√	√
	Microcytosis	√	√	√	√
	Macrocytosis	√	√	√	√
	Erythrocytosis	√	√	√	√
	Anaemia	√	√	√	√
	Hypochromia	√	√	√	√
	Abnor. RBC Distr.	√	√	√	√
	Iron Deficiency?	√	√	√	√

Type	Flag	Whole Blood		Predilute (PD)	
		CBC	CBC+DIFF	CBC	CBC+DIFF
	RBC Clump?	√	√	√	√
	Abnormal RBC Channel	√	√	√	√
	Abnormal HGB Channel	√	√	√	√
PLT	PLT Clump?	√	√	√	√
	Thrombocytosis	√	√	√	√
	Thrombocytopenia	√	√	√	√
	Abnor. PLT Distr.	√	√	√	√

NOTE

- "√" indicates that flags will be displayed in the mode."x" indicates that flags will not be displayed in the mode.
- When the PLT value is less than $100 \times 10^9 /L$, a manual count by the microscope is recommended.

7.6 Functions of the Buttons

7.6.1 Previous/Next

Click **Previous**, and the screen will display the sample analysis results prior to the current one.

Click **Next**, and the screen will display the sample analysis results after the current one.

7.6.2 Next Sample

Click this button, and you can enter the information and analysis mode of the sample to be tested before performing the sample analysis. See section **7.3 Entering Sample Information**.

7.6.3 Validate/Cancel Validation

After running sample, you can click **Validate** to validate the sample. After validating, the button will be replaced by **Cancel Validation**. After validating, you cannot edit the sample information and the result.

If the current sample has been validated, the sample validation can be cancelled by clicking **Cancel Validation**. After cancelling the validation, you can edit the sample information and the result.

7.6.4 Print

You can click **Print** to print the report of the sample result.

7.6.5 Sample Information

You can browse and edit the sample information of the selected sample in the **Sample Analysis** interface. The operation procedures are as shown below:

1. Click **Previous** or **Next** to choose a record, then click **Sample Info.** to enter the sample information setting interface as shown in Figure 7-3.

Figure 7-3 Sample Information

The screenshot shows a dialog box titled "Sample Info." with the following fields and values:



Sample ID	Species	
2	Dog	
Mode	Ref. Group	
Whole Blood	CBC+DIFF	Dog Default
Patient Name	Age	Gender
Patient ID Number	Owner Name	Veterinarian
Sampling Time	Delivery Time	Operator
2018/09/26 16:59	2018/09/26 16:59	develop
Run Time	Report Time	Approver
2018/09/26 16:59	2018/09/27 19:05	
Diagnosis	Remarks	



Buttons: Apply, OK, Cancel

2. Enter sample information with reference to the parameter description in Table 7-4.

Table 7-4 Parameter Description of Sample Information

Parameter	Meaning	Operation
Sample ID	Number of the selected sample.	It will be displayed automatically, and you can modify it manually. NOTE <ul style="list-style-type: none"> • Letters, numbers and all characters that can be entered through the keyboard (including special characters) are allowed for the QC ID, but the number must end with a nonzero number. Chinese and other languages (such as Japanese, Korean, etc) are not supported. • The length of the entries ranges from 1 to 25 and the entries shall not be empty • The last character of a sample ID must be numeric, but a string of "0" only is not an acceptable sample ID.
Species	Animal type of sample.	It will be displayed automatically, and cannot be modified.
Ref. Group	The reference group to which the species belongs. The reference group options are displayed according to the selected Species . The result is judged according to the reference range of the reference group and the result beyond the normal range will be flagged.	Select from the dropdown list. NOTE Refer to Select from the dropdown list. NOTE Refer to 5.4.2 Ref. Range for the setting of the reference group and range. for the setting of the reference group and range.
Patient Name	Name of patient.	Enter in the textbox directly.
Age	Age of patient.	Select the age unit from the dropdown list (Year, Month, Week, Day or Hour) and enter a number into the box next to the age unit.
Gender	Gender of patient. Including: <ul style="list-style-type: none"> • (Null) • Male • Female 	Select from the dropdown list.
Patient ID Number	ID number of patient.	Enter in the textbox directly.

Parameter	Meaning	Operation
Mode	<p>Analysis mode of the sample, including blood sample and measurement mode.</p> <p>Among which, blood sample modes include:</p> <ul style="list-style-type: none"> ● Whole Blood ● Predilute <p>Measurement modes include:</p> <ul style="list-style-type: none"> ● CBC <p>Complete Blood Count with no differential count for white blood cells. The counting results comprise 13 parameters, 3 histograms (including WBC, RBC and PLT), and one BASO scattergram.</p> ● CBC+DIFF <p>Complete Blood Count plus differential count for white blood cells. The counting results comprise 23 measurement parameters, 3 DIFF scattergram, 1 BASO scattergram, and 3 histograms (including WBC, RBC and PLT).</p> 	<p>It will be displayed automatically, and cannot be modified.</p>
Owner Name	Name of the patient's owner.	Enter in the textbox directly.
Sampling Time	Date and time when the sample is collected.	<p>Click the date control for the settings.</p> <ul style="list-style-type: none"> ● The input sequence of the controls is the same with the date format on the top right corner of the dialog box. For example, if the data format is yyyy/MM/dd HH:mm, you should input the data in the sequence of year, month, date, hour, and minute. ● Click  or  to select a date and time or enter the information in the textbox directly. ● Click  to clear the current data and re-enter the information. <p>NOTE</p> <p>The sampling time can be no later than the current system time.</p>

Parameter	Meaning	Operation
Delivery Time	Date and time when the sample is delivered.	<p>Click the date control for the settings.</p> <ul style="list-style-type: none"> The input sequence of the controls is the same with the date format on the top right corner of the dialog box. For example, if the data format is yyyy/MM/dd HH:mm, you should input the data in the sequence of year, month, date, hour, and minute. Click  or  to select a date and time or enter the information in the textbox directly. Click  to clear the current data and re-enter the information. <p>NOTE</p> <p>The delivery time can be no later than the current system time and cannot be earlier than the sampling time.</p>
Operator	Personnel running the sample.	The parameter value is displayed automatically upon the completion of the sample analysis.
Run Time	Time when the sample is run.	The parameter value is displayed automatically upon the completion of the sample analysis.
Approver	Personnel validating the sample.	This parameter will be automatically displayed after the sample is validated.
Veterinarian	A physician who diagnoses and treats the patient.	Enter in the textbox directly.
Report Time	The date and time when the report is printed for the first time.	This parameter will be automatically displayed after the report is printed.
Diagnosis	Suspected diagnosis information.	Input in the textbox directly.
Remarks	Clarifications or notes.	Input in the textbox directly.

- Click **Apply** to save, or click **OK** to save and exit.

7.6.6 Customised Parameters

You can browse and edit the Customised Parameters results of the selected sample in the **Sample Analysis** interface. The procedures are shown as below:

- Click **Custom Para.** to enter the Customised Parameters setting interface as shown in Figure 7-4.

Figure 7-4 Customised Parameters

Custom Para.				
Para.	Flag	Value	Unit	Range
Blood Type				
RH Blood Group				
ESR				
C-reactive Protein				
Reticulocyte				

- Click the cell corresponding to its **Value** column of the parameter, and enter the value. If the unit and reference range of parameters have been set in the **Setup > Parameter > Custom Para.** interface, the corresponding unit and range (lower limit~upper limit) will be displayed in this tab. When both the value and range of parameters are numbers, and the number is out of the reference range, the relevant mark ↑ or ↓ will be displayed in the **Flag** column.

Please refer to **5.4.3 Customised Parameters** for Customised Parameters settings.

7.6.7 Communication

You can transmit the current sample data (except the background sample) to the LIS system in the **Sample Analysis** interface. The operation procedures are as shown below:

- Select the record to be communicated.
- Click **Comm.** Select **OK** in the pop-up dialog box.



NOTE

- Before communication, be sure that the language, unit and date of the analyser are the same as the LIS client if the LIS client is in use.
- If the result needing to be communicated are self-programmed species sample data, you need to be sure that the setting information (including the name of the new species, source species and the parameters displayed for the sample analysis results and so on) of the analyser are the same with the LIS client before communication. For more self-programmed species setting details of the analyser, please refer to **5.3.5 Self-programmed Species**.

7.6.8 Edit Result

NOTE

- You cannot edit the results of validated samples.
- You cannot edit the results of the background.
- In the CBC mode, only the results of the test parameters are available, the results concerning the percentage of the WBC diff parameters are not available.
- This button is displayed only when the edit result function is checked by the developer.

You can edit the parameter result of the selected sample as per the following steps.

1. Click  to unfold all function buttons.
2. Select the record to be edited.
3. Click **Edit Result**.

The **Edit Result** dialog box will pop up on the screen as shown in Figure 7-5.

Figure 7-5 Editing Parameter Result

Edit Result								
WBC	<input type="text" value="14.65"/>	10 ³ /uL	RBC	<input type="text" value="6.21"/>	10 ⁶ /uL	PLT	<input type="text" value="359"/>	10 ³ /uL
Neu%	<input type="text" value="68.2"/>	%	HGB	<input type="text" value="14.7"/>	g/dL	MPV	<input type="text" value="11.2"/>	fL
Lym%	<input type="text" value="22.2"/>	%	HCT	<input type="text" value="42.9"/>	%	PDW	<input type="text" value="15.7"/>	fL
Mon%	<input type="text" value="5.9"/>	%	RDW-CV	<input type="text" value="11.8"/>	%			
Eos%	<input type="text" value="3.3"/>	%	RDW-SD	<input type="text" value="31.4"/>	fL			
Bas%	<input type="text" value="0.4"/>	%						
			<input type="button" value="Apply"/>		<input type="button" value="OK"/>		<input type="button" value="Cancel"/>	

4. Modify the counting results of the corresponding sample parameters.
5. Click **Apply** or **OK** to save the changes.

If the sum of the percentage of the diff parameters is not equal to 100.00% or the WBC value is invalid after modification, the system will prompt in a message box that the entered value is invalid. Please re-enter after confirmation.

If the result of one parameter is modified, then the result of other related parameter(s) will be changed accordingly and the high or low/suspicious flags will also be updated.

NOTE

The result of the parameter that you modified manually will be flagged with an **M**. If any parameter result is then changed due to the one that you modified manually, it will be flagged with an **m**.

7.6.9 Delete

NOTE

- Validated samples are not allowed to be deleted.
 - The common user has no access to delete the sample records.
-

1. Click  to unfold all function buttons.
2. Click **Delete**, and then click **Yes** in the pop-up dialog box to delete the sample.

Figure 7-6 Delete Sample Records



8 Result Review

8.1 Introduction

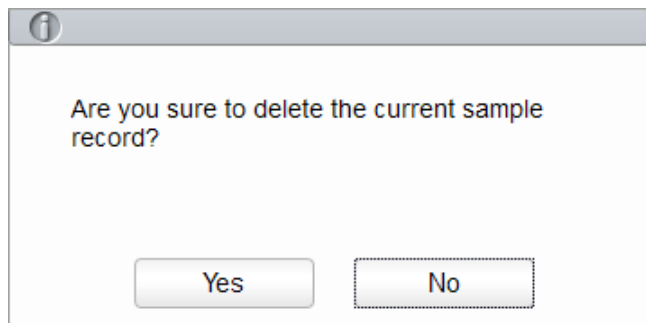
Upon the completion of each sample analysis, the analyser will automatically save the sample information, result data, flag messages, histograms and scattergrams to the Review Database.

In the **Review** Interface, you can browse the saved sample information, result data, flag messages, histograms and scattergrams, and can search, compare or export the saved sample information.

8.2 Interface Introduction

You can browse, search, compare, print, and export the existing results in the **Review** interface.

Click **Review** to enter the sample review interface. See Figure 8-1.

Figure 8-1 Review

The screenshot displays the Review interface with the following components:

- Navigation Tabs:** Home, Sample Analysis, Review (selected), QC, Reagent Management.
- Function buttons:** Validate, Cancel Validation, Print, Sample Info., Graph, Run Chart, Custom Para., Export.
- Table:**

Sample ID	Species	Patient Name	Mode	Status
2	Cat		WB-CBC+DIFF	[Icons]
1	Cat		WB-CBC+DIFF	[Icons]
BACKGROUND			WB-CBC+DIFF	[Icons]
Result list				
- Footer:**
 - Species: Cat
 - Sequence Number/Total number of results: 0/3
 - Current page/Total pages: 1 / 1
 - User: admin
 - Date/Time: 2018/09/30 08:39:03

Interface Description:

- Result list: you can browse detailed sample records.
- Function buttons: you can perform the operations such as comparing or searching the sample results, deleting and viewing the Run Charts, exporting and printing reports.
- Direction button: If you click different direction buttons, the list will move toward the corresponding directions.
 - From left to right, it indicates in sequence: the first column, moving to the left page, moving to the right page, and the last column.
 - From top to bottom, it indicates in sequence: the first page, the previous page, the next page, and the last page.

8.3 Sample List

The review interface shows a list of the analysed samples, which contains the sample ID, species, patient name, mode, status and results of various parameters and other information.

Click a sample or multiple samples in the list area, then you perform operations such as exporting in batch for the selected samples. To cancel the selection, click the selected samples again.

8.4 Functions of the Buttons

8.4.1 Validate

NOTE

After validating, you cannot edit the sample information and the result.

After running samples, you can validate the samples as per the following steps.

1. Click **Validate**.

A dialog box will pop up as shown below.

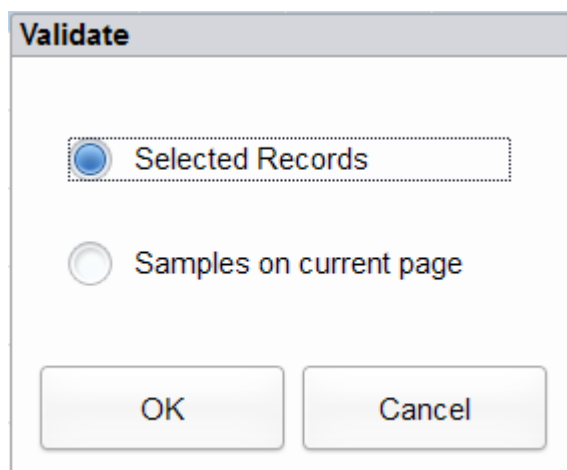

2. Select the sample which needs to be validated.
 - Selected Records: The selected sample results with blue background.
 - Samples on current page: Results of all the samples shown on the current page.
3. Click **OK**.

The system will prompt the validation results as shown in Figure 8-2.

Figure 8-2 Validation Results

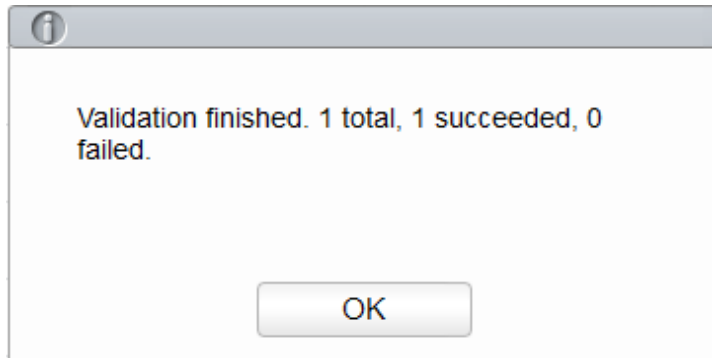

4. Click **OK** to close the message box.

8.4.2 Cancel Validation

NOTE

After cancelling the validation, you can edit the sample information and the result.

You can cancel the validation of validated samples. Detailed steps are shown below:

1. Click **Cancel Validation**.

A dialog box will pop up as shown below.

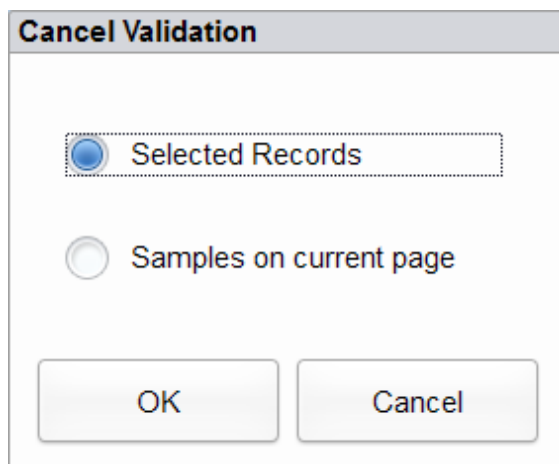

2. Select the sample which needs to be validated.
 - Select **Selected Records**, and the system will cancel the validation for the selected sample results.
 - Select **Samples on current page**, and the system will cancel the validation for all the samples on the current page.

3. Click **OK**.

The system will prompt the operation results as shown in Figure 8-3.

Figure 8-3 Validation Results

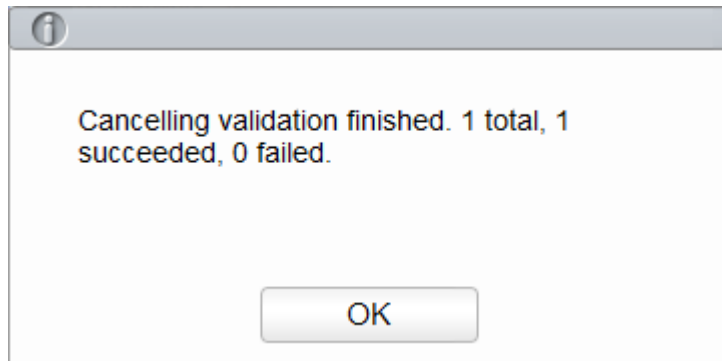

4. Click **OK** to close the message box.

8.4.3 Print

Click **Print** to print the result report of the selected sample.

8.4.4 Sample Info.

You can browse and edit sample information after the sample analysis is completed. Detailed steps are shown below:

1. Select a row of record to be edited from the result list, click **Sample Info**.

The interface as shown in Figure 8-4 will pop up on the screen.



Figure 8-4 Sample Information



Sample Info.		
Sample ID	Species	
<input type="text" value="1"/>	Dog	
Mode	Ref. Group	
Whole Blood	CBC+DIFF	Dog Default
Patient Name	Age	Gender
<input type="text"/>	<input type="text"/> Year	<input type="text"/>
Patient ID Number	Owner Name	Veterinarian
<input type="text"/>	<input type="text"/>	<input type="text"/>
Sampling Time	Delivery Time	Operator
2018/09/26 16:47	2018/09/26 16:47	develop
Run Time	Report Time	Approver
2018/09/26 16:47	//	<input type="text"/>
Diagnosis	Remarks	
<input type="text"/>	<input type="text"/>	
<input type="button" value="Apply"/> <input type="button" value="OK"/> <input type="button" value="Cancel"/>		

2. Enter sample information with reference to the parameter description in Table 8-1.

Table 8-1 Parameter Description

Parameter	It means	Operation
Sample ID	Number of the selected sample.	<p>It will be displayed automatically, and you can modify it manually.</p> <p>NOTE</p> <ul style="list-style-type: none"> • Letters, numbers and all characters that can be entered through the keyboard (including special characters) are allowed for the QC ID, but the number must end with a nonzero number. Chinese and other languages (such as Japanese, Korean, etc) are not supported. • The length of the entries ranges from 1 to 25 and the entries shall not be empty • If the sample ID entry method is auto increment, the last character of a sample ID must be numeric, but a string of "0" only is not an acceptable sample ID. See 5.9 Auxiliary Settings for the setting of sample ID entry method. • Different samples to be run cannot have the same sample ID..
Species	Animal type of sample.	It will be displayed automatically, and cannot be modified.
Ref. Group	<p>The reference group to which the sample belongs. The reference group options are displayed according to the selected Species.</p> <p>The result is judged according to the reference range of the reference group and the result beyond the normal range will be flagged.</p>	<p>Select from the dropdown list.</p> <p>NOTE</p> <p>Refer to 5.4.2 Ref. Range for the setting of the reference group and range.</p>
Patient Name	Name of patient.	Enter in the textbox directly.
Age	Age of patient.	Select the age unit from the dropdown list (Year, Month, Week, Day or Hour) and enter a number into the box next to the age unit.
Gender	<p>Gender of patient. Including:</p> <ul style="list-style-type: none"> • (Null) • Male • Female 	Select from the dropdown list.
Patient ID Number	ID number of patient.	Enter in the textbox directly.

Parameter	It means	Operation
Mode	<p>Analysis mode of the sample, including blood sample and measurement mode.</p> <p>Among which, blood sample modes include:</p> <ul style="list-style-type: none"> ● Whole Blood ● Predilute <p>Measurement modes include:</p> <ul style="list-style-type: none"> ● CBC Complete Blood Count with no differential count for white blood cells. The counting results comprise 13 parameters, 3 histograms (including WBC, RBC and PLT), and one BASO scattergram. ● CBC+DIFF Complete Blood Count plus differential count for white blood cells. The counting results comprise 23 measurement parameters, 3 DIFF scattergram, 1 BASO scattergram, and 3 histograms (including WBC, RBC and PLT). 	<p>It will be displayed automatically, and cannot be modified.</p>
Owner Name	Name of the patient's owner.	Enter in the textbox directly.
Sampling Time	Date and time when the sample is collected.	<p>Click the date control for the settings.</p> <ul style="list-style-type: none"> ● The input sequence of the controls is the same with the date format on the top right corner of the dialog box. For example, if the data format is yyyy/MM/dd HH:mm, you should input the data in the sequence of year, month, date, hour, and minute. ● Click  or  to select a date and time or enter the information in the textbox directly. ● Click  to clear the current data and re-enter the information. <p>NOTE</p> <p>The sampling time can be no later than the current system time.</p>

Parameter	It means	Operation
Delivery Time	Date and time when the sample is delivered.	<p>Click the date control for the settings.</p> <ul style="list-style-type: none"> The input sequence of the controls is the same with the date format on the top right corner of the dialog box. For example, if the data format is yyyy/MM/dd HH:mm, you should input the data in the sequence of year, month, date, hour, and minute. Click  or  to select a date and time or enter the information in the textbox directly. Click  to clear the current data and re-enter the information. <p>NOTE</p> <p>The delivery time can be no later than the current system time and cannot be earlier than the sampling time.</p>
Operator	Personnel running the sample.	The parameter value is displayed automatically upon the completion of the sample analysis.
Run Time	Time when the sample is run.	The parameter value is displayed automatically upon the completion of the sample analysis.
Report Time	The date and time when the report is printed for the first time.	This parameter will be automatically displayed after the report is printed.
Approver	Personnel validating the sample.	This parameter will be automatically displayed after the sample is validated.
Veterinarian	A physician who diagnoses and treats the patient.	Enter in the textbox directly.
Diagnosis	Suspected diagnosis information.	Input in the textbox directly.
Remarks	Clarifications or notes.	Input in the textbox directly.

- Click **Apply** to save, or click **OK** to save and exit.

8.4.5 Graph

In the **Review** interface, you can click **Graph** to browse the selected sample graph results, parameter results and flag messages. The procedures are shown as below:

- Select a result to review in graph interface.
- Click  to unfold all function buttons.
- Click **Graph** to enter the graph interface of the selected sample.

In the **Graph** interface, you can view sample information such as parameter results, graph results and flag messages. In addition, you can also print the analysis report as. See Figure 8-5.

Figure 8-5 Graphs Review

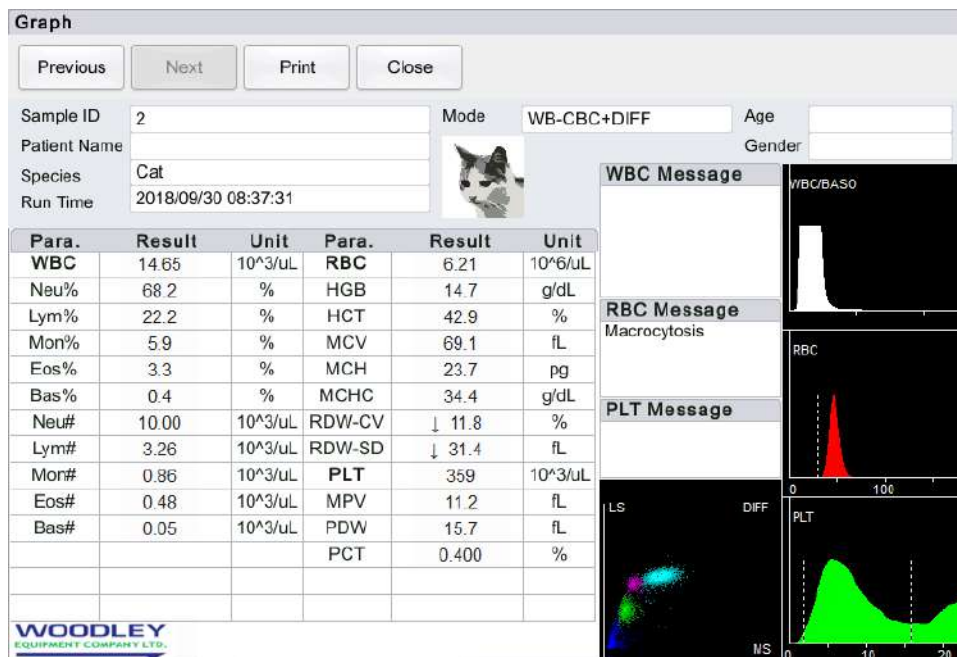

8.4.6 Run Chart

Operators can check and review run charts of sample parameter results in the database. There are three view modes: selected samples, samples on current page and samples on specified run dates.

- View the run chart of the selected sample (default)
 - a. Check no fewer than three sample records.
 - b. Click  to unfold all function buttons.
 - c. Click **Run Chart**.

The system pops up a dialog box as shown below.

Figure 8-6 Viewing the Run Chart of the Selected Sample

The 'Run Chart' dialog box contains the following elements:

- View Modes:**
 - Selected Records
 - Samples on current page
 - Run Date
- Date Range:** 2018/09/29 - 2018/09/29
- Buttons:** OK, Cancel

d. Click **OK**.

The screen will show the parameter result run chart of the selected sample. See Figure 8-7.

Figure 8-7 Run Chart

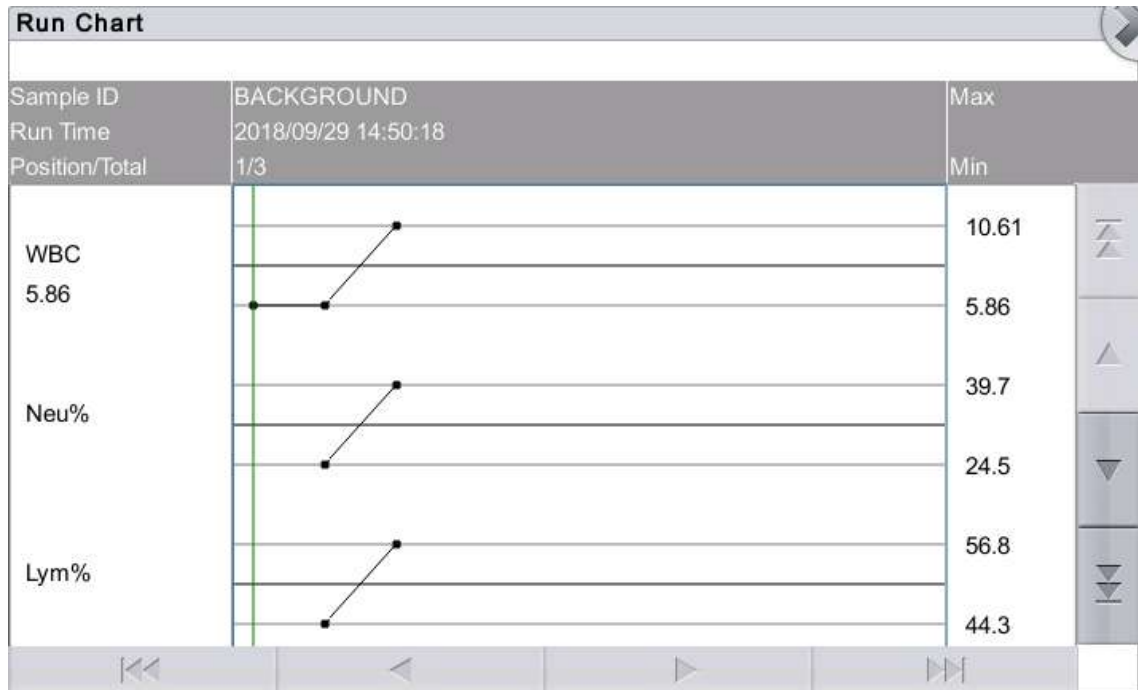

- View the run chart of samples on current page
 - a. Click  on the current page to unfold all function buttons.
 - b. Click the **Run Chart** button and select **Samples on current page** in the pop-up dialog box. See Figure 8-8.

Figure 8-8 Viewing the Run Chart of Samples on the Current Page

The Run Chart dialog box contains the following options:

- Selected Records
- Samples on current page
- Run Date

Below the options, there are two date selection fields: 2018/09/29 - 2018/09/29. At the bottom, there are **OK** and **Cancel** buttons.

c. Click **OK**.

The screen will show the parameter result run chart of the selected sample.

- View the run chart of samples on specified run dates
 - a. Click  to unfold all function buttons.
 - b. Click the **Run Chart** button, and select **Run Date** in the pop-up dialog box. See Figure 8-9.

Figure 8-9 Viewing the Run Chart of Samples on Specified Run Dates



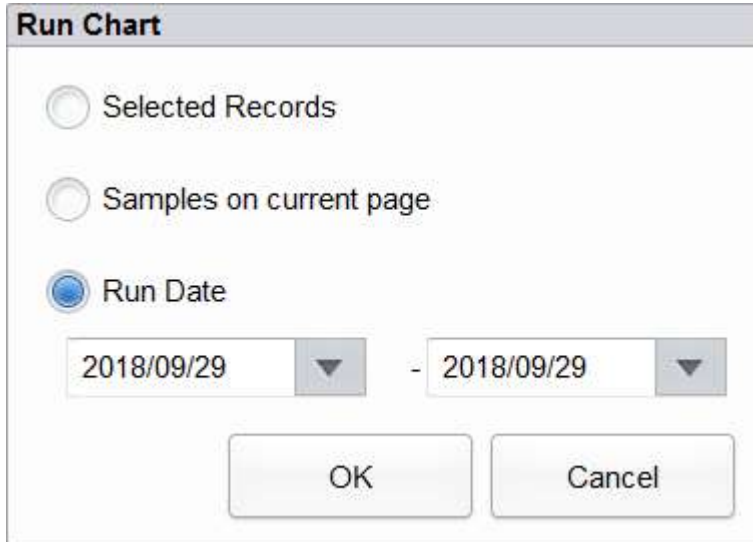
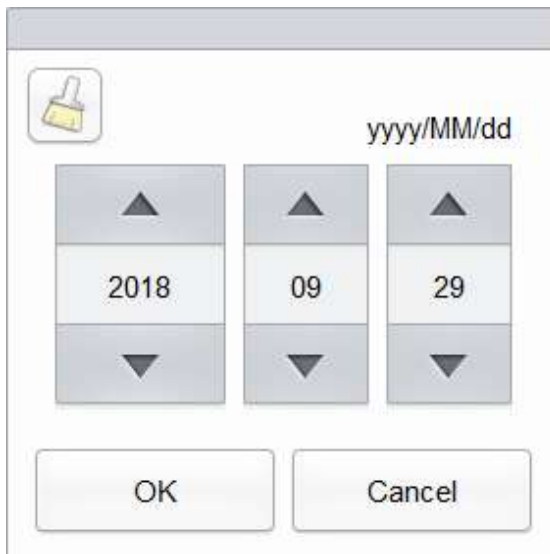

The dialog box titled "Run Chart" contains three radio button options: "Selected Records", "Samples on current page", and "Run Date". The "Run Date" option is selected. Below the options are two date input fields, each with a dropdown arrow, separated by a hyphen. Both fields contain the date "2018/09/29". At the bottom are "OK" and "Cancel" buttons.

- c. Click the date edit box, set a date range in the pop-up dialog box, then click **OK**.



The date edit dialog box features a paperclip icon in the top left corner. The date format "yyyy/MM/dd" is displayed in the top right. The date is entered using three spinners: the first shows "2018", the second shows "09", and the third shows "29". Each spinner has up and down arrow buttons. At the bottom are "OK" and "Cancel" buttons.

The input sequence of the controls is the same with the date format on the top right corner of the dialog box. For example, if the data format is **yyyy/MM/dd**, you should input the data in the sequence of year, month, and date.

Click  or  to select a date and time or enter the information in the textbox directly.

Click  to clear the current data and re-enter the information.

- d. Click **OK**.

The screen will show the parameter result run chart of the selected sample.

8.4.7 Customised Parameters

You can browse and edit the Customised Parameters results of the selected sample in the **Review** interface. The procedures are shown as below:

1. Select one sample.
2. Click  to unfold all function buttons.
3. Click **Custom Para.** to enter the Customised Parameters setting interface as shown in Figure 8-10.

Figure 8-10 Customised Parameters

Custom Para.				
Para.	Flag	Value	Unit	Range
Blood Type				
RH Blood Group				
ESR				
C-reactive Protein				
Reticulocyte				

4. Click the cell corresponding to its **Value** column of the parameter, and enter the value.
If the unit and reference range of parameters have been set in the **Setup > Parameter > Custom Para.** interface, the corresponding unit and range (lower limit~upper limit) will be displayed in this tab. When both the value and range of parameters are numbers, and the number is out of the reference range, the relevant mark ↑ or ↓ will be displayed in the **Flag** column.

Please refer to **5.4.3 Customised Parameters** for Customised Parameters settings.

8.4.8 Export

The operator can export the sample data to the USB flash disk for backup. There are two ways of exporting the sample data: exporting selected records and exporting records of specified dates.

- Export Selected Records
 - a. Insert a USB flash disk in the USB interface on the analyser.
 - b. Select records to be backed up, and click **Export**.

As shown in the following figure, the export range of the system is **Selected Records** by default.

Figure 8-11 Export Selected Records

The screenshot shows a dialog box titled "Export". It has two main sections. The first section, "Select Export Range", contains two radio buttons: "Selected Records" (which is selected) and "Records of the Specified Dates". Below the second radio button are two date pickers, both showing "2018/09/29". The second section, "Select Export Content", contains four checkboxes, all of which are checked: "Sample Info.", "Result", "Graphs and Flags", and "Custom Para.". At the bottom of the dialog are two buttons: "OK" and "Cancel".

- c. Select the content to be exported according to the actual demand.
Content available for export includes: sample information., parameter results, graphs and flags, and Customised Parameters.
- d. Click **OK**.
- e. Select the data export path in the popup dialog box, enter the backup file name.
The file will be exported to the root directory of the USB flash disk (**/udisk/sda1**) and named in the format of **SampleInfo_yyyyMMdd_hhmmss.csv**. Among which, **yyyymmdd_hhmmss** means data export year, month, date, hour, minute, and second.

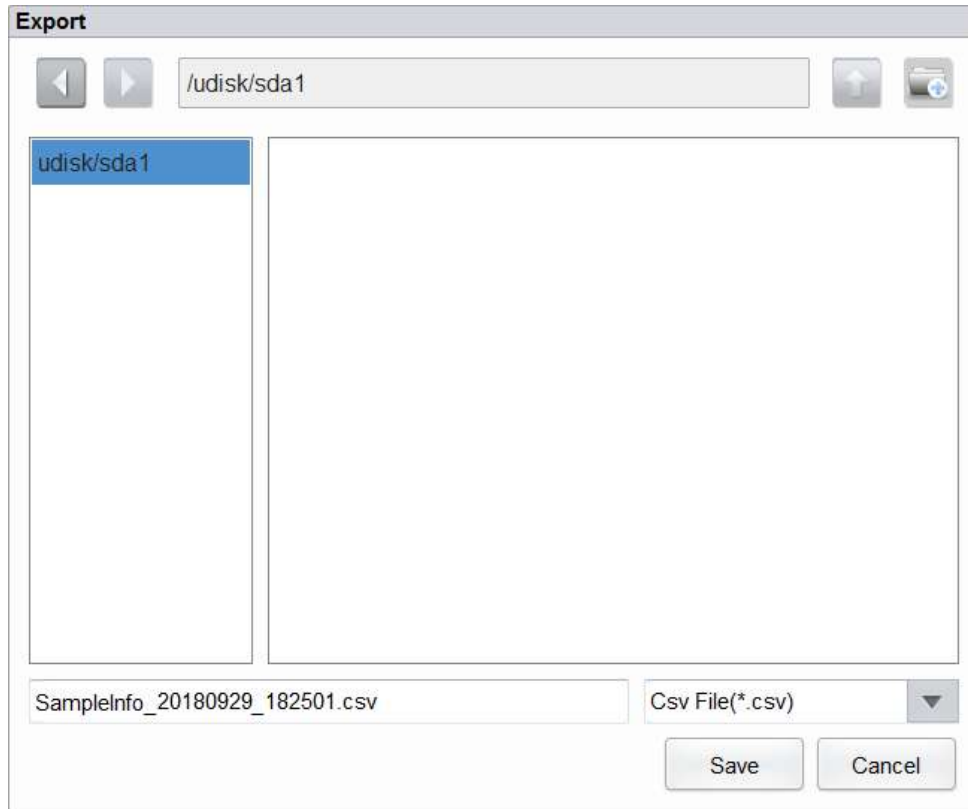

- f. Click **Save**.

The system pops up a dialog box as shown below to indicate that the data export is successful.

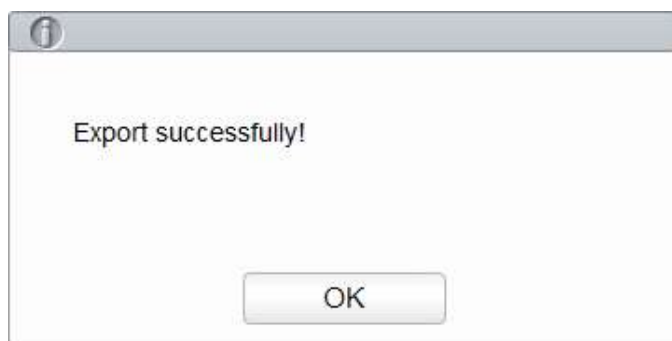

- Export Records of the Specified Dates
 - a. Insert a USB flash disk in the USB interface on the analyser.
 - b. Click **Export**.
 - c. Select **Records of the Specified Dates** and set the run date range of sample in the two date textboxes. See Figure 8-12.

Figure 8-12 Export Records of the Specified Dates

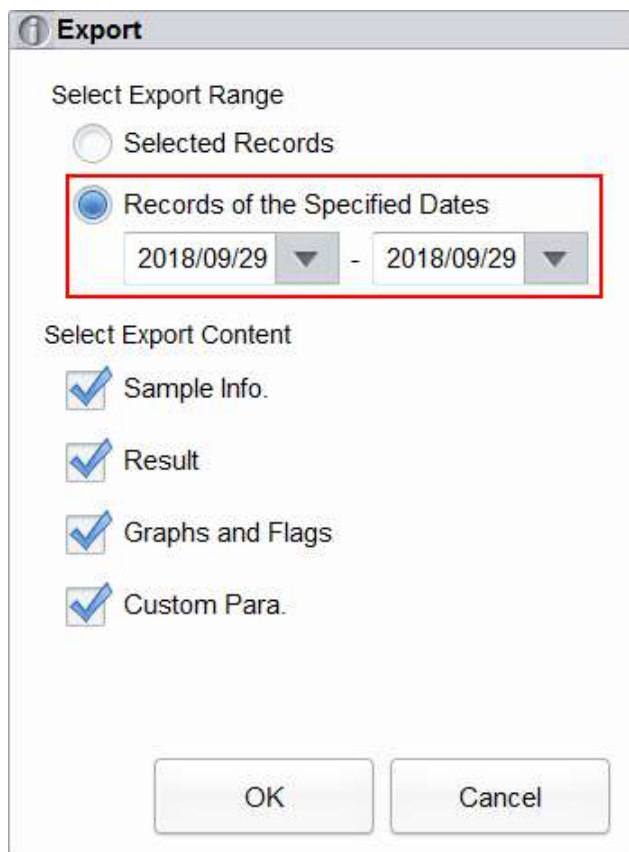

- d. Select the content to be exported according to the actual demand.
Content available for export includes: sample information., parameter results, graphs and flags, and Customised Parameters.
- e. Click **OK**.
- f. Select the data export path in the popup dialog box and enter the backup file name.
The file will be exported to the root directory of the USB flash disk (/udisk/sda1) and named in the format of SampleInfo_yyyyMMdd_hhmmss.csv. Among which, yyyyMMdd_hhmmss means data export year, month, date, hour, minute, and second.
- g. Click **Save**.
The system pops up a dialog box as shown below to indicate that the data export is successful.

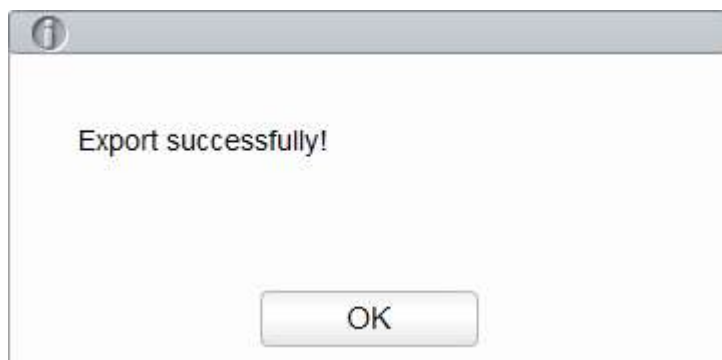

8.4.9 Edit Result

NOTE

- You cannot edit the results of validated samples.
- Background result cannot be edited!
- In the **CBC** mode, only the results of the test parameters are available, the results concerning the percentage of the WBC diff parameters are not available.
- This button is displayed only when the edit result function is checked by the developer.

You can edit the parameter result of the selected sample as per the following steps.

1. Select a row of record to be edited from the result list and click the **Edit Result** button.

The **Edit Result** dialog box will pop up on the screen as shown in Figure 8-13.

Figure 8-13 Editing Parameter Result

Edit Result								
WBC	<input type="text" value="14.65"/>	10 ³ /uL	RBC	<input type="text" value="6.21"/>	10 ⁶ /uL	PLT	<input type="text" value="359"/>	10 ³ /uL
Neu%	<input type="text" value="68.2"/>	%	HGB	<input type="text" value="14.7"/>	g/dL	MPV	<input type="text" value="11.2"/>	fL
Lym%	<input type="text" value="22.2"/>	%	HCT	<input type="text" value="42.9"/>	%	PDW	<input type="text" value="15.7"/>	fL
Mon%	<input type="text" value="5.9"/>	%	RDW-CV	<input type="text" value="11.8"/>	%			
Eos%	<input type="text" value="3.3"/>	%	RDW-SD	<input type="text" value="31.4"/>	fL			
Bas%	<input type="text" value="0.4"/>	%						
				<input type="button" value="Apply"/>	<input type="button" value="OK"/>	<input type="button" value="Cancel"/>		

2. Modify the counting results of the corresponding sample parameters.
3. Click **Apply** or **OK** to save the changes.

If the sum of the percentage of the diff parameters is not equal to 100.00% or the WBC value is invalid after modification, the system will prompt in a message box that the entered value is invalid. Please re-enter after confirmation.

If the result of one parameter is modified, then the result of other related parameter(s) will be changed accordingly and the high or low/suspicious flags will also be updated.

8.4.10 Query

You can view the test results of a sample within a certain test date range by entering the query conditions. The procedures are shown as below:

1. Click the **Query** button to enter the multi-conditional query dialog box as shown below.

Figure 8-14 Query Conditions

Query

Sample ID

Patient Name

Patient ID Number

Species ▼

Para. ▼ ▼

Run Date ▼ - ▼

Sample status

Not Validated

Not Printed

Not Transmitted

Auto select

- Determine the query conditions as needed.

For the specific parameter description, see Table 8-2.

Table 8-2 Parameter Description of Query Conditions

Parameter	It means	Operation Description
Sample ID	Sample ID to be queried.	Input in the textbox directly.
Patient Name	Name of patient.	Input in the textbox directly.
Patient ID Number	ID number of patient.	Input in the textbox directly.
Species	Species type of patient.	Select from the dropdown list.
Para.	Parameter and its range to be queried.	Select a parameter from the first dropdown list, and a comparison symbol (\geq , $>$, \leq , $<$, $=$) from the second dropdown list, then input a value in the textbox. For example, if you select WBC and $>$, then input 3 in the textbox. The sample results which RBC value is greater than $3.0 \times 10^{12}/L$ will be queried and displayed.

Parameter	It means	Operation Description
Run Date	Test date range of sample.	Select the starting and ending dates of the sample test in the two data controls successively.
Sample status	Status of validation, printing or communication of the sample. <ul style="list-style-type: none"> • Not Validated • Not Printed 	Please choose according to the actual situation. The default value is Not Validated .

NOTE

- **Auto select** checked by default indicates that the query result is being selected (with a blue background colour). If it's unchecked, the query result will remain on a white background colour.
- Click **All Samples** to close the current window, display all the samples again and restore all the filter conditions to the default values.

3. Click **Query**.

The system will display all the query results which meet the conditions.

8.4.11 Delete

NOTE

- Validated samples are not allowed to be deleted.
- The common user has no access to delete the sample records.

1. Select one or several sample records to be deleted.

2. Click **Delete**.

A prompt box will pop up on the screen as shown below.

Figure 8-15 Delete Sample Records

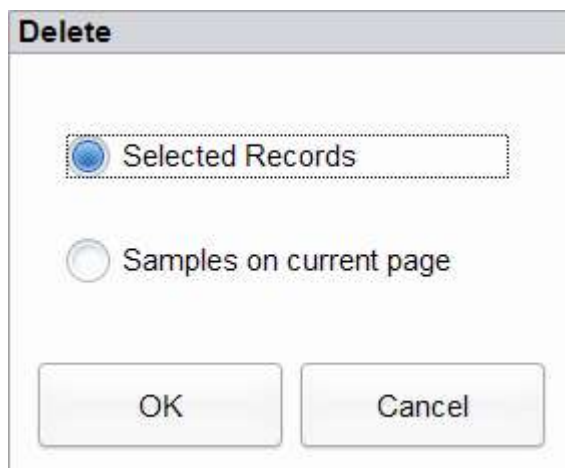

3. Select one or several sample records to be deleted according to the actual situation.
 - Selected Records: The selected sample results with blue background.
 - Samples on current page: Results of all the samples shown on the current page.
4. Click **OK** to delete the selected record(s).

8.4.12 Communication

NOTE

- Before communication, be sure that the language, unit and date of the analyser are the same as the LIS client if the LIS client is in use.
- If the result to be communicated is self-programmed species sample data, you need to be sure that the setting information (including the name of the new species, source species and the parameters displayed for the sample analysis results and so on) of the analyser are the same as the LIS client before communicating. For more self-programmed species setting details, please refer to **5.3.5 Self-programmed Species**.

You can transmit the selected sample data, the data in the current page or the data within the specified date range to the LIS system in the **Review** interface.

- Selected Records
 - a. Select one or several sample data to be communicated in the result list.
 - b. Click  to show all function buttons.
 - c. Click **Comm.**

A dialog box will display as shown in Figure 8-16. The default option is **Selected Records**.

Figure 8-16 Communication for Selected Data

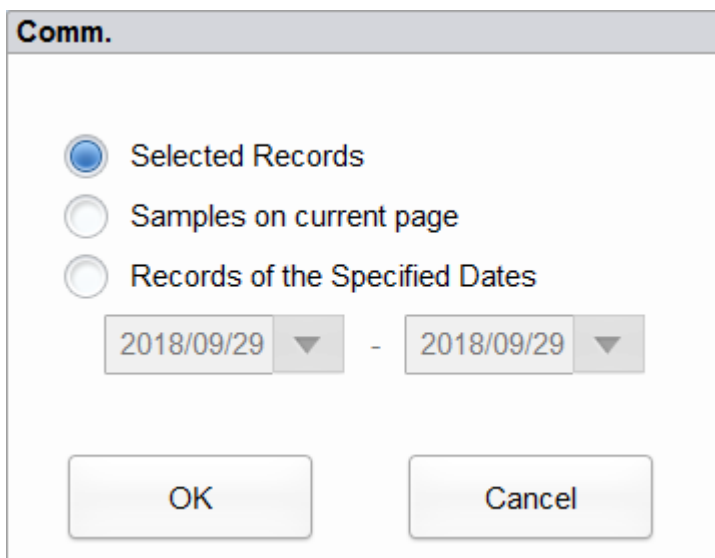

The dialog box titled "Comm." contains the following elements:

- Three radio button options:
 - Selected Records
 - Samples on current page
 - Records of the Specified Dates
- Two date input fields, both displaying "2018/09/29", with a hyphen between them.
- Two buttons at the bottom: "OK" and "Cancel".

- d. Click **OK**.

After the data is transmitted to LIS, a message box as shown below will display.

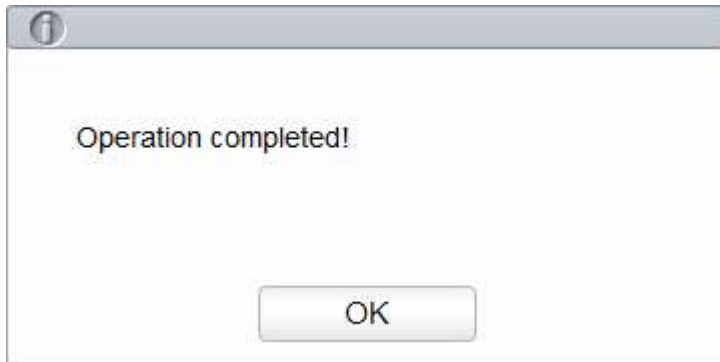

- e. Click **OK** to close the message box.
- Samples on current page
 - a. Click  to unfold all function buttons.
 - b. Click **Comm.**
Select **Samples on current page**. See Figure 8-17.

Figure 8-17 Communication for Data on Current Page



- c. Click **OK**.

After the data is transmitted to LIS, a message box as shown below will display.

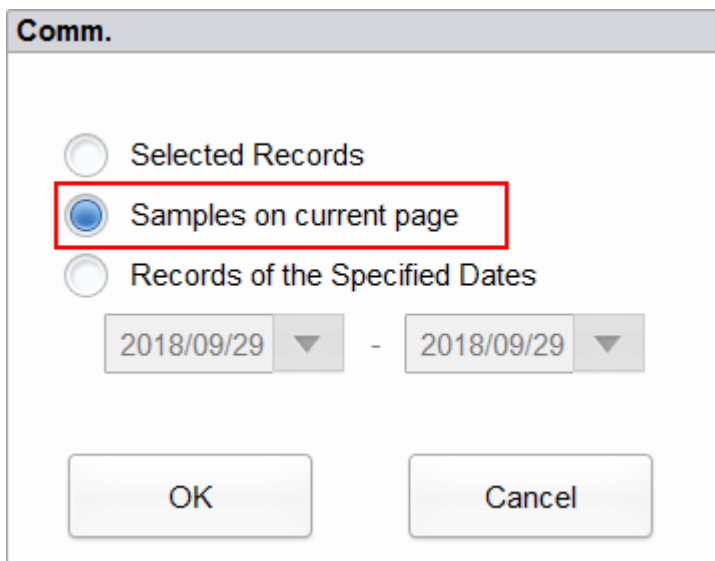
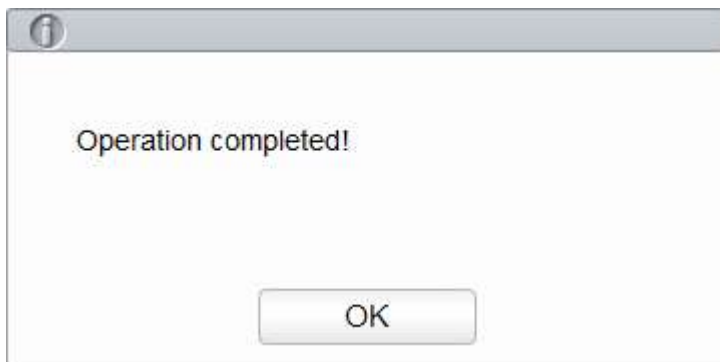

- d. Click **OK** to close the message box.
- Records of the Specified Dates
 - a. Click  to show all function buttons.
 - b. Click **Comm.**.
 - c. Select **Specified Data**, and set the starting and ending dates of data to be communicated. See Figure 8-18.

Figure 8-18 Communication for Data on Specified Dates



Comm.

Selected Records

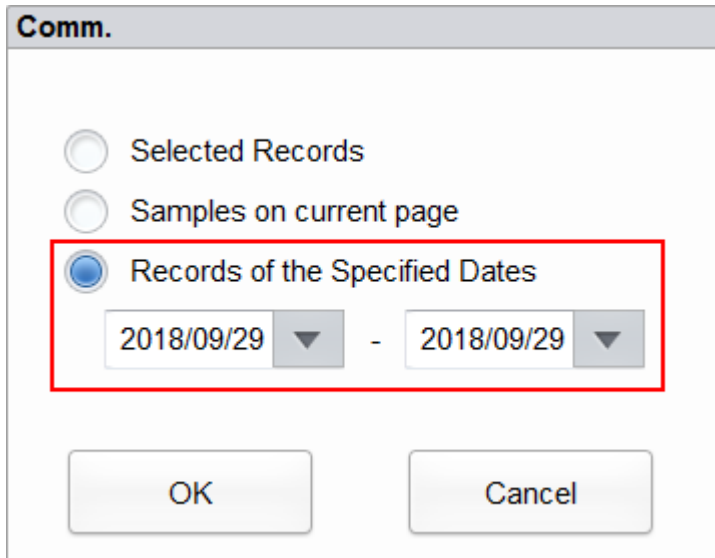
Samples on current page

Records of the Specified Dates

2018/09/29 ▼ - 2018/09/29 ▼

OK Cancel

- d. Click **OK**.
- After the data is transmitted to LIS, a message box as shown below will display.

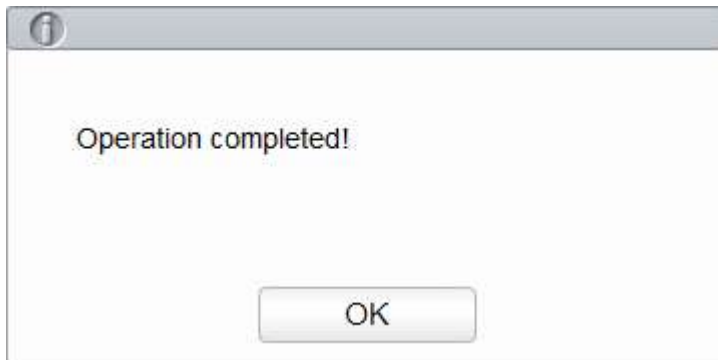

i

Operation completed!

OK

- e. Click **OK** to close the message box.

9 Quality Control

9.1 Introduction

Quality Control (QC) consists of strategies and procedures that measure the precision and stability of the analyser. The results imply the reliability of the sample results. QC involves measuring materials with known, stable characteristics at frequent intervals.

Analysis of the results with statistical methods allows the inference that sample results are reliable. Woodley Equipment Company recommends running a QC program periodically with low, normal and high level controls.

NOTE

- You should only use the Woodley Equipment Company-specified controls and reagents. Store and use the controls and reagents by following the instructions for use of the controls and reagents.
 - Controls beyond their Exp. date shall not be used. Controls (similar to standard blood samples) must be well mixed before use.
 - General users only have the access for browsing and executing the QC analysis other than editing.
 - Haematology QC material should be tested according to your hospitals quality assurance protocols.
-

9.2 L-J Quality Control

9.2.1 QC Principle

In the L-J quality control, quality control can be applied to 23 parameters. You can set the QC information by setting the QC file before performing the QC analysis. Each QC file can be assigned 1 Lot number for high, normal and low level controls. Each QC file can store up to 500 QC results. When there are more than 500 QC results, the new QC results will overwrite the oldest results in sequence.

9.2.2 QC Settings



All the samples, controls, calibrators, reagents, wastes and areas in contact with them are potentially biohazardous. Wear proper personal protective equipment (e.g. gloves, lab uniforms, etc.) and follow laboratory safety procedures when handling them and the relevant areas in the laboratory.

NOTE

Only users with administrator-level access can edit the L-J settings.

Before running a new batch of controls, you need to assign a QC file to each batch of controls. You can complete the QC settings by setting QC information in the QC files.

9.2.2.1 Entering QC Information

The administrator can import the QC information by the following three methods:

- Manual Entry
- QR Code
- File

Entering QC Information Manually

1. Click **QC > QC Settings** to enter the **QC Settings** interface as shown in Figure 9-1.

Figure 9-1 L-J Quality Control

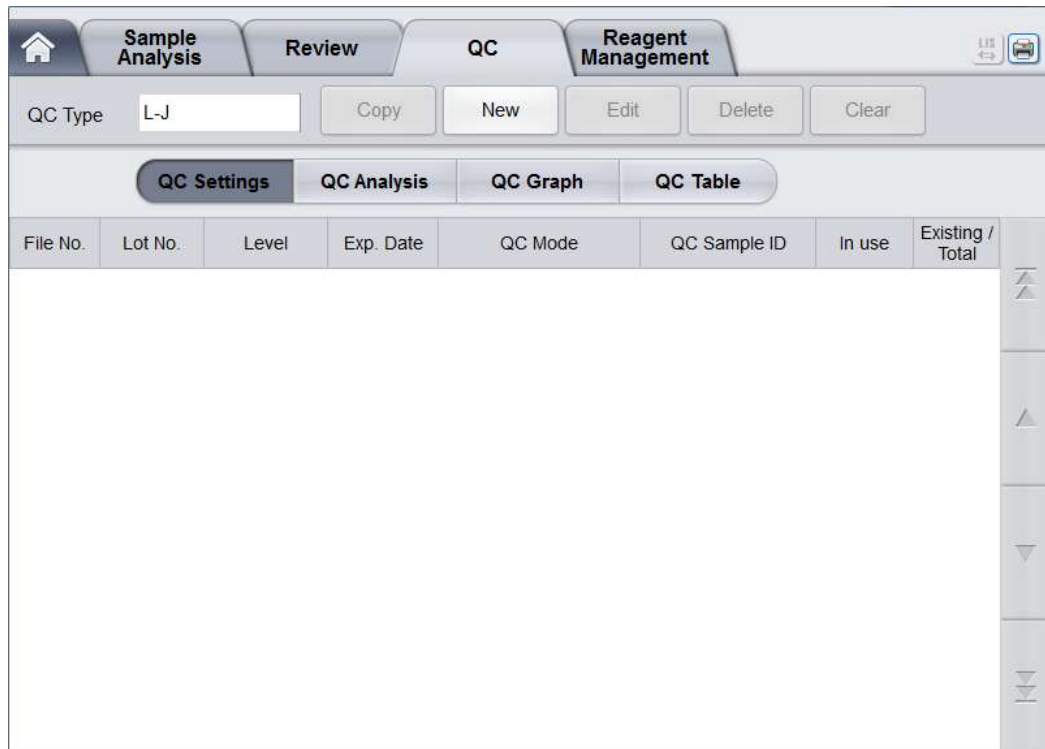

- Click the **New** button, or select a QC file (**Existing/Total** is **0/500**) without QC counting results and click the **Edit** button.

The interface as shown in Figure 9-2 will pop up on the screen.

Figure 9-2 Entering QC Information

You can also select the QC file of which data has been set and then click **Copy**, and edit the content based on the original data.

- Set related information of the controls with reference to Table 9-1.

Table 9-1 QC File Information

Parameter	Parameter Description	Operation Description
File No.	QC file No..	Read only.
Lot No.	Lot number of controls.	Enter into the textbox directly. NOTE The lot No. cannot be empty and up to 16 digits can be entered. You can enter characters, numbers, letters and special characters, but no Chinese characters are allowed.
Level	Level of the controls, including 3 levels, i.e. High, Normal and Low.	Select from the dropdown list.
Exp. Date	Exp. date of the controls.	The default Exp. Date is the current system date and needs to be changed to the actual Exp. date of the controls.

Parameter	Parameter Description	Operation Description
QC Mode	QC mode of the controls, including Whole Blood-CBC+DIFF and Predilute-CBC+DIFF .	Select from the dropdown list.
QC Sample ID	<p>Number of the QC sample</p> <ul style="list-style-type: none"> Users need to set the number of the controls here if he/she is used to performing the analysis with the controls placed among the daily samples. See section 9.2.3.2 Completing QC Analysis in the Sample Analysis Interface. If the user performs the analysis in the QC Analysis interface, the ID cannot be entered. 	<p>Enter into the textbox directly.</p> <p>NOTE</p> <ul style="list-style-type: none"> Letters, numbers and all characters that can be entered through the keyboard (including special characters) are allowed for the Sample ID. Chinese and other languages (such as Japanese, Korean, etc) are not supported. The length of the entries ranges from 1 to 25. The last character of a sample ID must be numeric, but a string of "0" only is not an acceptable sample ID.
Target	Target of the QC parameter.	Enter the targets in the cell corresponding to the expected QC parameter according to the control target list with the corresponding lot No.
Limits (#)	Limits (#) of the QC parameter.	<p>Enter the limits in the cell corresponding to the expected QC parameter according to the control target list with the corresponding lot No.</p> <p>NOTE</p> <p>You can click Set Limits to set the display form of the limits or the calculation method of the limits among the preset values.</p> <ul style="list-style-type: none"> By SD: the limits displays in form of absolute value. Click 2SD or 3SD to select either double or triple standard deviation to be the limits. By CV: the limits displays in form of percentage. Click 2CV or 3CV to select either double or triple coefficient of variation to be the limits.
In use	<p>Set if you want to specify the QC sample ID in the selected file so that you can run the QC sample in the interface other than the QC interface.</p> <ul style="list-style-type: none"> If it's checked, you can run the sample with the corresponding sample ID in any interface and the system will run the QC analysis for this sample. If it's not checked, you can only run the QC sample in the QC interface. 	It's unchecked by default. Set the parameter according to the actual situation.

Parameter	Parameter Description	Operation Description
Existing/Total	The existing data and total QC results in the current QC file. Up to 500 QC results can be saved for each QC file.	Read only.

4. According to the target list of the corresponding lot No., enter the target and limits into the textboxes of the parameters to be included in the QC run.
5. Click the **Save** button to save all the settings of the QC.

Importing the QC Information by QR code

NOTE

- Be sure to connect the QR code scanner to a USB interface on the right side of the device before importing QC information.
- There is LED (Light Emitting Diode) light source when the QR code scanner is turned on. Do not look directly at the light beam.
- If you need to import the QC information, please contact the customer engineer to get the QC target list containing QR code or QC file in **.qcs** format.

1. Click **QC > QC Settings** to enter the **QC Settings** interface.
2. Click the **New** button, or select a QC file (**Existing/Total** is **0/500**) without QC counting results and click the **Edit** or **Copy** button.

The following dialog box will pop up. See Figure 9-3.

Figure 9-3 Importing QC Information

Para.	Target	Limits (#)	Para.	Target	Limits (#)
WBC			MCH		
Neu%			MCHC		
Lym%			RDW-CV		
Mon%			RDW-SD		
Eos%			PLT		
Bas%			MPV		
Neu#			PDW		
Lym#			PCT		
Mon#			P-LCR		
Eos#			P-LCC		
Bas#					
RBC					
HGB					
HCT					
MCV					

File No.

Lot No.

Level

Exp. Date

QC Mode

QC Sample ID

Set Limits Import Save Close

6. Click **OK**.

The screen will display the QC information of QR Code. As shown in Figure 9-4.

Figure 9-4 L-J QC Information

Para.	Target	Limits (#)	Para.	Target	Limits (#)
WBC	3.36	0.50	MCH	23.9	2.5
Neu%	50.6	16.0	MCHC	320.0	30.0
Lym%	37.9	21.0	RDW-CV	14.7	3.0
Mon%	6.1	3.7	RDW-SD	46.3	8.0
Eos%	5.4	4.7	PLT	47	20
Bas%	1.9	1.9	MPV	8.8	3.0
Neu#	1.70	0.48	PDW	14.2	3.0
Lym#	1.27	0.68	PCT	0.042	0.042
Mon#	0.20	0.13	P-LCR	22.4	10.0
Eos#	0.19	0.19	P-LCC	10	10
Bas#	0.07	0.07			
RBC	2.58	0.24			
HGB	6.0	6.0			
HCT	19.3	2.0			
MCV	74.8	5.0			

File No.

Lot No.

Level

Exp. Date

QC Mode

QC Sample ID

Editor:

7. Enter the Lot No. and QC Sample ID.

8. Click **Save** to save the QC information.

Importing the QC Information by .qcs File

NOTE

- Be sure to connect the a USB flash disk contained QC file in **.qcs** format to a USB interface on the right side of the device before importing QC information.
- There is LED (Light Emitting Diode) light source when the QR code scanner is turned on. Do not look directly at the light beam.
- If you need to import the QC information, please contact the customer engineer to get the QC target list containing QR code or QC file in **.qcs** format.

1. Click **QC > QC Settings** to enter the **QC Settings** interface.
2. Click the **New** button, or select a QC file (**Existing/Total** is **0/500**) without QC counting results and click the **Edit** or **Copy** button.

The following dialog box will pop up. See Figure 9-5.

Figure 9-5 Importing QC Information

Para.	Target	Limits (#)	Para.	Target	Limits (#)
WBC			MCH		
Neu%			MCHC		
Lym%			RDW-CV		
Mon%			RDW-SD		
Eos%			PLT		
Bas%			MPV		
Neu#			PDW		
Lym#			PCT		
Mon#			P-LCR		
Eos#			P-LCC		
Bas#					
RBC					
HGB					
HCT					
MCV					

File No.

Lot No.

Level

Exp. Date

QC Mode

QC Sample ID

3. Click **Import > File**, as shown in the following figure.

Import

File type

QR Code
 File

4. Click **OK**.
The following dialog box will pop up. See Figure 9-6.

Figure 9-6 Import

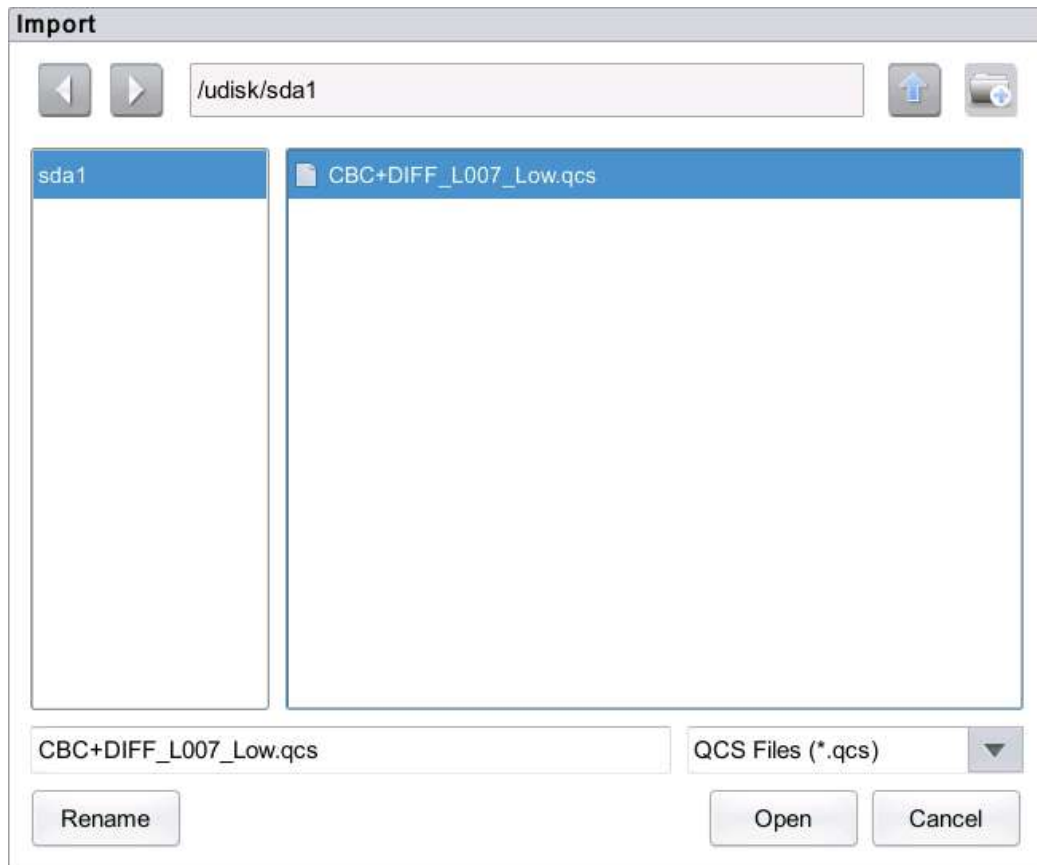

5. Select an import path for the file

The file will be imported by the root directory of the USB flash disk (**/udisk/sda1**).

6. Select the QC file to be import.

7. Click **Open**.

The following dialog box will pop up.



8. Click **OK**.

The screen will display the QC information of current file. As shown in Figure 9-7.

Figure 9-7 L-J QC Information

Para.	Target	Limits (#)	Para.	Target	Limits (#)
WBC	3.36	0.50	MCH	23.9	2.5
Neu%	50.6	16.0	MCHC	320.0	30.0
Lym%	37.9	21.0	RDW-CV	14.7	3.0
Mon%	6.1	3.7	RDW-SD	46.3	8.0
Eos%	5.4	4.7	PLT	47	20
Bas%	1.9	1.9	MPV	8.8	3.0
Neu#	1.70	0.48	PDW	14.2	3.0
Lym#	1.27	0.68	PCT	0.042	0.042
Mon#	0.20	0.13	P-LCR	22.4	10.0
Eos#	0.19	0.19	P-LCC	10	10
Bas#	0.07	0.07			
RBC	2.58	0.24			
HGB	6.0	6.0			
HCT	19.3	2.0			
MCV	74.8	5.0			

File No.

Lot No.

Level

Exp. Date

QC Mode

QC Sample ID

Editor:

9. Enter the Lot No. and QC Sample ID.
10. Click **Save** to save the QC information.

9.2.2.2 Deleting QC File

If you want to delete the QC files which will not be used any more, please take the following steps:

1. Click **QC** to access the **QC** interface.
2. Click **QC Settings** to enter the **QC Settings** interface.
3. Select the QC file to be deleted, and click **Delete**.

The interface pops up a dialog box as shown below.-



Are you sure to delete the QC file (1) and its counting results?

4. Click **Yes**.

All selected QC files together with their QC results will be completely deleted.

9.2.2.3 Clearing QC results

If you want to delete QC results of a specified file, please take the following steps:

1. Click **QC** to access the **QC** interface.
2. Click **QC Settings** to enter the **QC Settings** interface.
3. Select the QC file in which the QC results are expected to be cleared, and click **Clear**.

The interface pops up a dialog box as shown below.

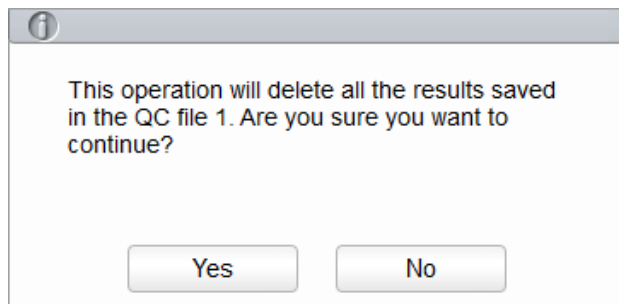

4. Click **Yes**.

QC results in the selected QC file will be deleted. See the picture below. The value in the **Existing/Total** column will be restored to the initial value.

File No.	Lot No.	Level	Exp. Date	QC Mode	QC Sample ID	In use	Existing / Total
1	L001	Normal	2019/09/29	Whole Blood-CBC+DIFF	QC001	<input type="checkbox"/>	0/500

9.2.3 Quality Control Analysis

After completing the QC settings, you can choose one of the following two modes according to the selected QC mode to run the quality control samples.

- Completing QC analysis in the **QC Analysis** interface
- Completing QC analysis in the **Sample Analysis** interface

9.2.3.1 Completing QC Analysis in the QC Analysis Interface



All the samples, controls, calibrators, reagents, wastes and areas in contact with them are potentially biohazardous. Wear proper personal protective equipment (e.g. gloves, lab uniforms, etc.) and follow laboratory safety procedures when handling them and the relevant areas in the laboratory.

**WARNING**

- The sample probe is sharp and potentially biohazardous. Exercise caution to avoid contact with the probe when working around it.
 - The sample may spill from the unclosed collection tubes and cause biohazard. Exercise caution to the unclosed collection tubes.
 - Broken tubes broken may cause personal injury and/or biohazard. Be sure to place the collection tubes in the right adapter before running, otherwise, the collection tubes may be broken and cause biohazard.
 - Keep your clothes, hair and hands away from the moving parts to avoid injury.
 - Reagents can be irritating to the eyes, skin, and mucosa. Wear proper personal protective equipment (e.g. gloves, lab uniforms, etc.) and follow laboratory safety procedures when handling them in the laboratory.
 - If the reagent accidentally comes in contact with your eyes or skin, rinse immediately with water.
-

**CAUTION**

- Running quality controls in presence of errors may lead to incorrect analysis results. If you see the error alarms when running the quality controls, please stop and resume the analysis until the errors are removed.
 - Do not re-use such disposable products as collection tubes, test tubes, capillary tubes, etc.
 - Sample clump may lead to incorrect analysis results. Check if clump exists before running the controls; if it does, handle it as per the related laboratory procedures.
-

NOTE

- You should only use the Woodley Equipment Company-specified controls and reagents. Store and use the controls and reagents as instructed by instructions for use of the controls and reagents. Using other controls may lead to incorrect QC results.
 - Invert the controls multiple times before testing.
 - Only use Woodley Equipment Company-specified disposable products including vacutainer blood collection tube, vacutainer blood collection tubes with anticoagulant and capillary tubes etc.
-

After completing the QC settings, users can perform the QC analysis in the **QC Analysis** interface. Detailed steps are shown below:

1. Click **QC** to access the **QC** interface.
2. Click **QC Analysis** and enter the QC analysis interface as shown in Figure 9-8.

Figure 9-8 QC Analysis

QC Type: L-J Edit Result Restore Previous Next Print

QC Settings **QC Analysis** QC Graph QC Table

File No.: 1 QC Mode: Whole Blood-CBC+DIFF Lot No.: L001
 Existing / Total: 0/500 Level: Normal Exp. Date: 2019/09/29
 Editor: admin QC Sample ID: QC001

Para.	Result	Unit	Para.	Result	Unit
WBC			MCV		
Neu%			MCH		
Lym%			MCHC		
Mon%			RDW-CV		
Eos%			RDW-SD		
Bas%			PLT		
Neu#			MPV		
Lym#			PDW		
Mon#			PCT		
Eos#					
Bas#					
RBC					
HGB					
HCT					

0/0

3. Select the QC file No. to be run.

The screen will display the corresponding information and QC parameters.

4. Be sure that the level of the control to be run is the same with the current QC file, and the control to be run is not expired.
5. Prepare the controls according to the set control mode and control instructions.

Predilute the controls with reference to **6.5 Sample Collection and Handling** and get diluted QC samples if the QC mode is **Predilute-CBC+DIFF**.

NOTE

Be sure to evaluate predilute stability based on your laboratory's sample population and sample collection techniques or methods.

6. Invert the prepared control as shown below to mix it well.

Figure 9-9 Mixing the Controls

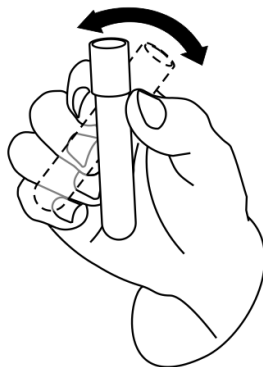

7. In the ready for counting state (namely, the indicator light of the main unit is green), place the controls under the sample probe where the probe can aspirate the well-mixed controls.
8. Press the aspirate key and start running the controls.
9. Upon the completion of the aspiration, you'll hear a beep and you can remove the controls.

When the running of QC analysis is complete, the QC results will be displayed in the current screen (as shown in Figure 9-10) and saved in the QC file automatically.

Figure 9-10 QC Analysis Results

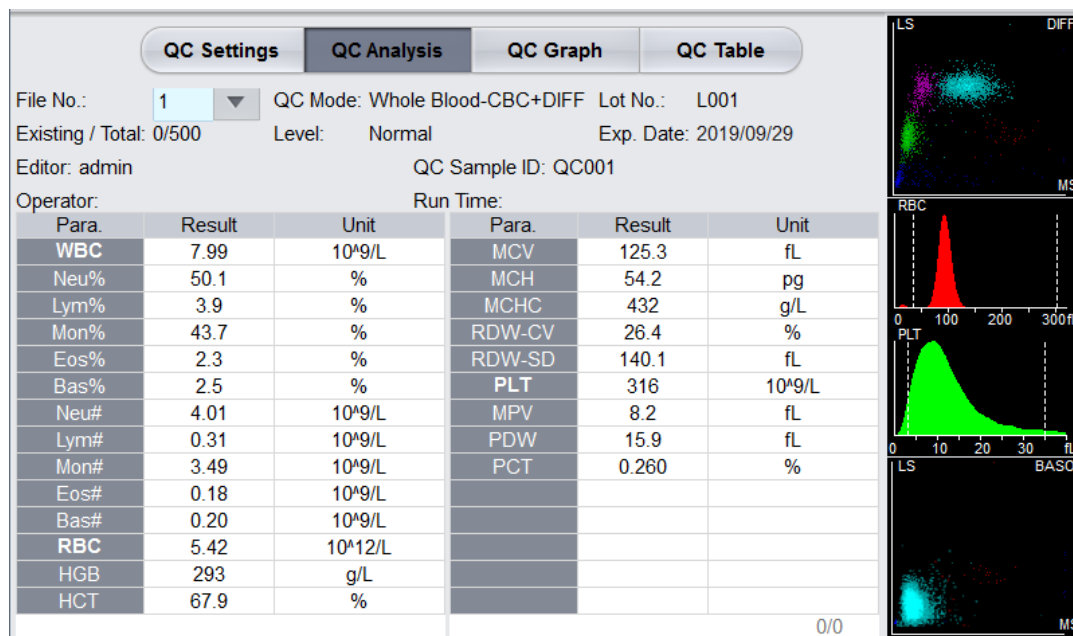

10. Perform the above procedures to continue running the controls if necessary.

NOTE

- If the QC file is outdated, its valid period will be displayed in red.
- “↑” or “↓” alarm symbol will be displayed next to the results with deviations exceeding the set limits.

9.2.3.2 Completing QC Analysis in the Sample Analysis Interface



All the samples, controls, calibrators, reagents, wastes and areas in contact with them are potentially biohazardous. Wear proper personal protective equipment (e.g. gloves, lab uniforms, etc.) and follow laboratory safety procedures when handling them and the relevant areas in the laboratory.

**WARNING**

- The sample probe is sharp and potentially biohazardous. Exercise caution to avoid contact with the probe when working around it.
- The sample may spill from the unclosed collection tubes and cause biohazard. Exercise caution to the unclosed collection tubes.
- Broken collection tubes may cause personal injury and/or biohazard. Be sure to place the collection tubes in the right adapter before running, otherwise, the collection tubes may be broken and cause biohazard.
- Keep your clothes, hair and hands away from the moving parts to avoid injury.
- Reagents can be irritating to the eyes, skin, and mucosa. Wear proper personal protective equipment (e.g. gloves, lab uniforms, etc.) and follow laboratory safety procedures when handling them in the laboratory.
- If the reagent accidentally comes in contact with your eyes or skin, rinse immediately with water..

**CAUTION**

- Running quality controls in presence of errors may lead to incorrect analysis results. If you see the error alarms when running the quality controls, please stop and resume the analysis until the errors are removed.
- Do not re-use such disposable products as collection tubes, test tubes, capillary tubes, etc.
- Sample clump may lead to incorrect analysis results. Check if clump exists before running the controls; if it does, handle it as per the related laboratory procedures.

NOTE

- You should only use the Woodley Equipment Company-specified controls and reagents. Store and use the controls and reagents as instructed by instructions for use of the controls and reagents. Using other controls may lead to incorrect QC results.
- Invert the controls multiple times before testing.
- Only use the Woodley Equipment Company-specified disposable products including vacutainer blood collection tube, vacutainer blood collection tubes with anticoagulant and capillary tubes etc.
- If the blood-sample mode is **Predilute**, then a reminder of predilute counting will pop up if the user presses the aspirate key to perform the counting. To close the prompt, please refer to **5.9 Auxiliary Settings**.

After completing the QC settings, you can place the controls among the daily samples and perform analysis together in the **Sample Analysis** interface. After the analysis is completed, the system will store the results to the QC file with the corresponding ID.

Specific steps for performing QC analysis in the **Sample Analysis** interface are as follows:

1. Prepare the controls according to the set control mode and control instructions.

Predilute the controls with reference to **6.5 Sample Collection and Handling** and get diluted QC samples if the QC mode is **Predilute-CBC+DIFF**.

NOTE

Be sure to evaluate predilute stability based on your laboratory's sample population and sample collection techniques or methods.

2. Click **Next Sample** in the **Sample Analysis** screen.

The interface pops up a dialog box as shown in Figure 9-11.

Figure 9-11 Entering Next Sample Information

3. Enter the set QC Sample ID in the **Sample ID** edit box (other options can be ignored). Refer to **9.2.2.1 Entering QC Information** for the setting of the QC Sample ID.
4. Mix the prepared controls well.
5. In the ready for counting state (namely, the indicator light of the main unit is green), place the controls under the sample probe where the probe can aspirate the well-mixed controls.
6. Press the aspirate key and start running the controls.
7. Upon the completion of the aspiration, you'll hear a beep and you can remove the controls. When the running of the controls is complete, the QC results will be saved in the QC file automatically.
8. Perform the above procedures to continue running the controls if necessary.

NOTE

- If the QC file is outdated, its valid period will be displayed in red.
- “↑” or “↓” alarm symbol will be displayed next to the results with deviations exceeding the set limits.

9.2.3.3 Edit Result

NOTE

This button is displayed only when the edit QC result function is checked by the developer.

Clicking **Edit** will allow you to edit the QC analysis result after the QC analysis is performed. See Figure 9-12.

Figure 9-12 Editing QC Results

The edited data will be marked with an **E**. See the picture below.

Para.	Result	Unit
WBC	E 7.01	10 ³ /uL

9.2.3.4 Restore Result

Clicking Restore will allow the QC analysis results to be restored to the original results. After the data is restored, the E mark will disappear.

9.2.3.5 Previous/Next

Click **Previous**, and the screen will display the QC analysis result prior to the current one.

Click **Next**, and the screen will display the QC analysis result after the current one.

9.2.3.6 Print

You can click **Print** to print the report of the QC analysis result.

9.2.4 QC Result Review

After running controls, you can review the QC results in the following two forms:

- QC Graph
- QC Table

9.2.4.1 Graph



All the samples, controls, calibrators, reagents, wastes and areas in contact with them are potentially biohazardous. Wear proper personal protective equipment (e.g. gloves, lab uniforms, etc.) and follow laboratory safety procedures when handling them and the relevant areas in the laboratory.

You can review the result of L-J QC graph as per the following steps.

1. Click **QC** to access the QC interface.
2. Click **QC Graph** to enter the interface as shown in Figure 9-13.

Figure 9-13 L-J QC Graph Interface

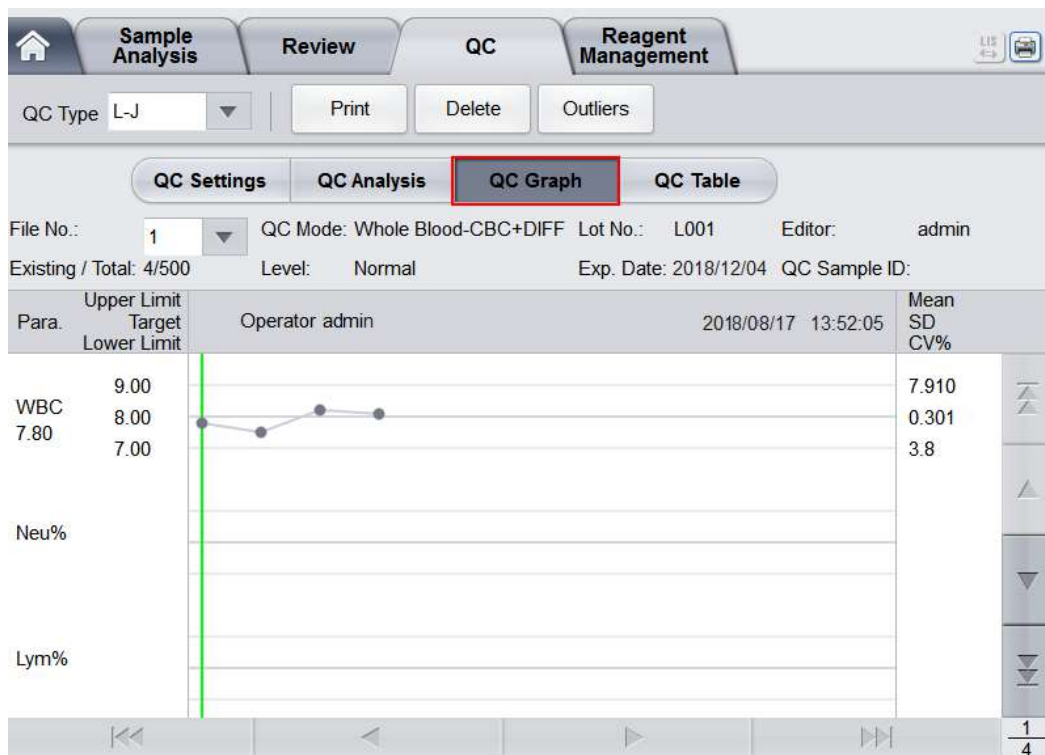

3. Select the QC file No. you want to review.
The screen will display the corresponding information and the graph. See Figure 9-14.

Figure 9-14 QC Graph

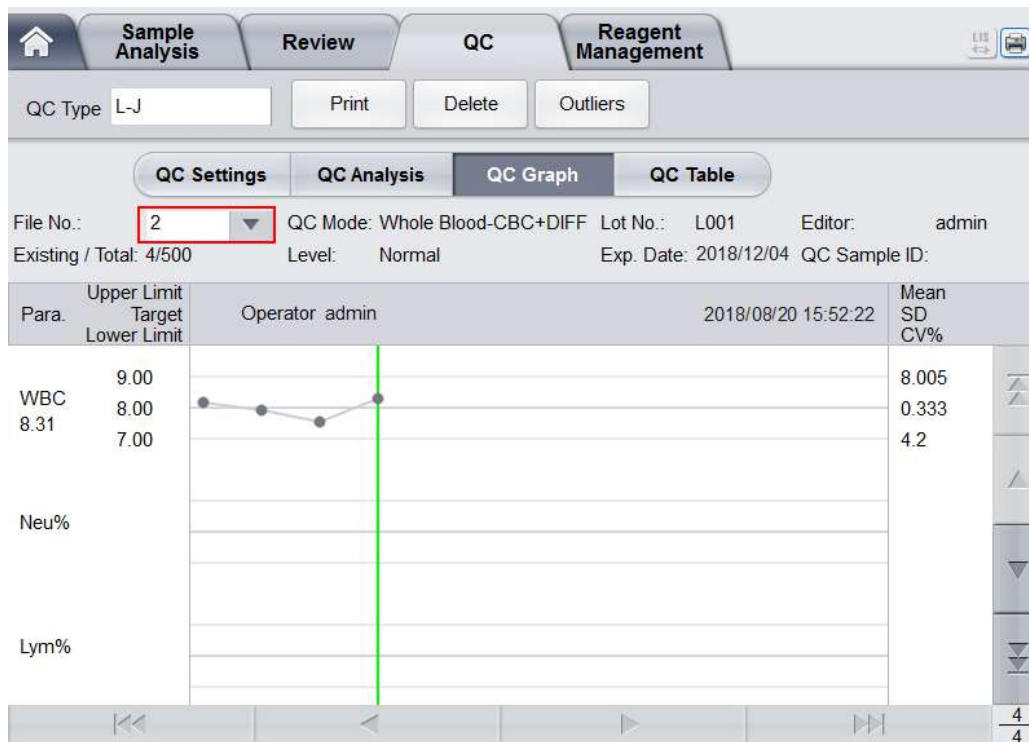

- Click the buttons at the right side of the QC graph, then you can browse QC graphs of different parameters; click the buttons at the bottom of the QC graph, then you can browse all QC results.

Introduction to the Graph Interface

Figure 9-15 L-J QC Graph Interface

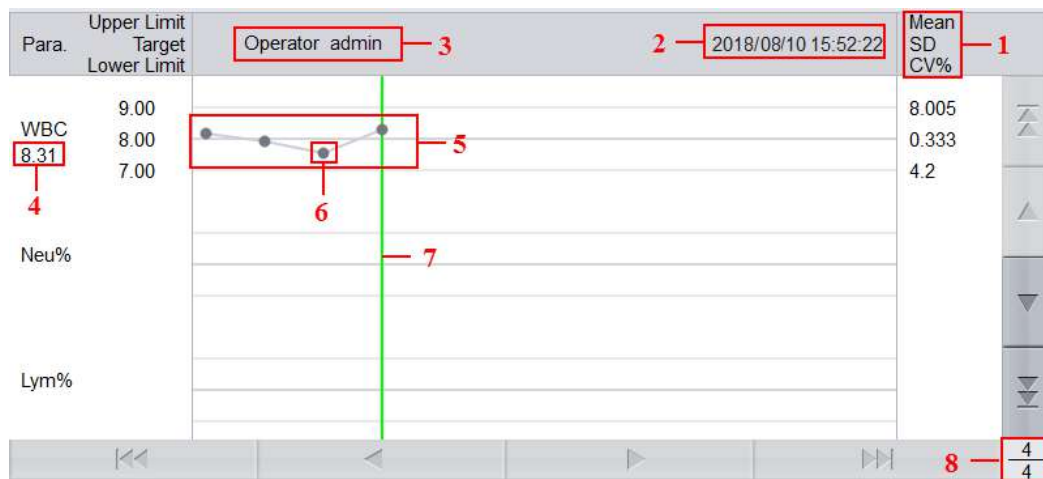

Interface Description:

- The Mean, SD and CV% of all the QC results of each parameter in the current graph.
- The saving date and time of the QC points located on the green line.
- The user operating the QC analysis and obtained the QC points located on the green line.
- The QC results of the parameters that correspond to the QC points located on the green line.
- The QC points in each graph are displayed from left to right according to the sequence from the earliest to the latest. The QC points are connected by a line to illustrate the distribution trend.

6 - The QC point corresponds to each QC result. Only the selected QC point displays its value under the parameter. The black QC point indicates the value is within the limit; the red QC point indicates the value is out of the limit.

7 - When you click a QC point in the graph, the QC points of other parameters are saved together with this one will be marked by a green line.

8 - The relative position of the QC point located on the green line and the total QC points saved currently.

NOTE

The outliers are excluded from the calculation of Mean, SD and CV%.

Delete

The administrator can delete the QC results by the following steps:

- Delete a single QC result
 - a. Move the green line to the desired QC result, and click **Delete**.
 - b. Select **Current Data** in the pop-up dialog box as shown in Figure 9-16.

Figure 9-16 Deleting Current QC Data (QC Graph)

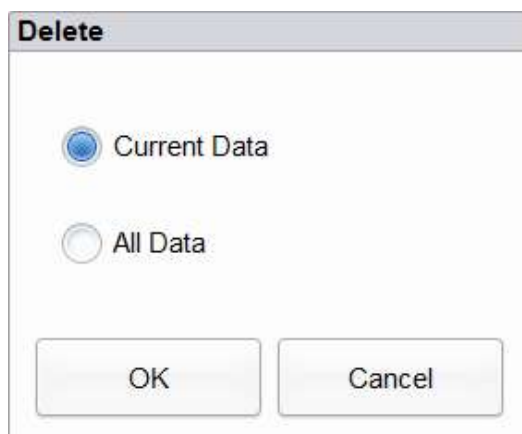

- c. Click **OK**.
- Deleting all the QC results in the current QC file
Click **Delete**, select **All Data** in the pop-up dialog box, then click **OK**. See Figure 9-17.

Figure 9-17 Deleting all QC Data (QC Graph)

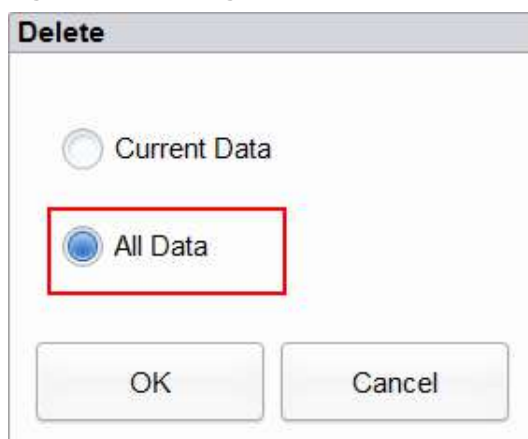

Entering the Reasons for the Outliers

Do as follows to enter the reasons for the outliers:

1. Move the green line to the desired QC point, and then click **Outliers**.

The pop-up window displays the QC results, reference values and deviation limits of all parameters corresponding to the green line as shown in Figure 9-18.

The QC results exceeding the limit will be displayed in red.

Figure 9-18 Enter Cause of Outliers

	WBC	Neu%	Lym%	Mon%	Eos%	Bas%	Neu#
Target	8.00						
Limits (#)	1.00						
Outliers Data	↓ 6.57						

Cause of Outliers

Control not Mixed Well
 Control Ineffective
 Control Expired
 Reagent Contaminated
 Reagent Expired
 Others

OK Cancel

2. You can select the reason from the given ones or manually enter the reasons (up to 200 characters) into the textbox after selecting **Others**.
3. Click **OK** to save the reasons for the outliers and exit.

NOTE

If you enter the reason for the group of QC points whose results are actually within the limits, then their corresponding QC data both in the QC Graph and QC Table will be displayed in red. And the data will return in black if you cancel the reason and then save the changes.

Print

You can have the QC data of the current page or all QC data in the QC file printed by clicking the Print button.

NOTE

The printed QC graph will not show any parameters which are not involved in the quality control.

9.2.4.2 Table



All the samples, controls, calibrators, reagents, wastes and areas in contact with them are potentially biohazardous. Wear proper personal protective equipment (e.g. gloves, lab uniforms, etc.) and follow laboratory safety procedures when handling them and the relevant areas in the laboratory.

1. Click **QC** to access the **QC** interface.
2. Click **QC Table** to access the interface as shown in Figure 9-19.

Figure 9-19 L-J QC Table Interface

	Date	Time	WBC	Neu%	Lym%	Mon%	Eos%	Bas%	N
Target	/	/	3.36	50.6	37.9	6.1	5.4	1.9	1
Limits (#)	/	/	0.50	16.0	21.0	3.7	4.7	1.9	0
1	2018/09/30	08:44:32	↓ 0.16	50.0	41.3	4.7	5.1	1.0	**

3. Select the QC file No. you want to review.
The screen will display the corresponding information and the table.
4. Click the buttons at the bottom of the table to browse the QC data of desired parameters; click the buttons on the right of the table to browse the QC results.

Editing

Choose a row in the QC table and click **Edit Result**, then you can edit the selected QC data.

The edited data will be marked with an **E**. See Figure 9-20.

Figure 9-20 Editing QC Results

	Date	Time	WBC
Target	/	/	7.07
Limits (#)	/	/	1.00
1	2018/08/21	11:30:21	E 6.08

Restoring

Click **Restore** to cancel the editing of the QC results. After the data is restored, the **E** mark will disappear.

Delete

With the administrator-level access, users can delete the selected QC data, QC data on the current page and all QC data.

- Delete a selected QC result
 - a. Click the column containing the desired QC result, and then click **Delete**.
 - b. Select **Current Data** in the pop-up dialog box as shown in Figure 9-21.

Figure 9-21 Deleting Current QC Data (QC Table)

The image shows a dialog box titled "Delete". It contains three radio button options: "Current Data" (which is selected), "Current Page Data", and "All Data". At the bottom of the dialog box, there are two buttons: "OK" and "Cancel".

- c. Click **OK**.
- Delete QC data on the current page
 - a. Click **Delete** on the page which contains the QC results expected to be deleted.
 - b. Select **Current Page Data** in the pop-up dialog box as shown in Figure 9-22.

Figure 9-22 Deleting all QC Data (QC Table)

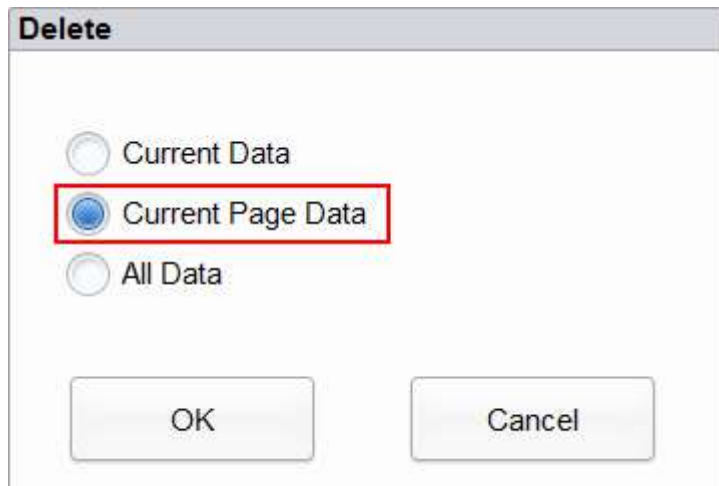

c. Click **OK**.

- Delete all QC results

NOTE

Please be careful to perform this operation as it will delete all QC data of the selected QC file and cannot be reverted.

- Click **Delete**.
- Select **All Data** in the pop-up dialog box.

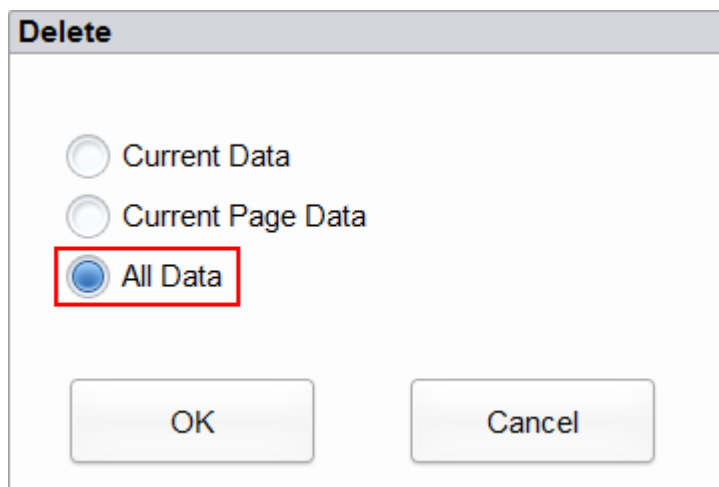

c. Click **OK**.

The interface pops up a dialog box as shown below.

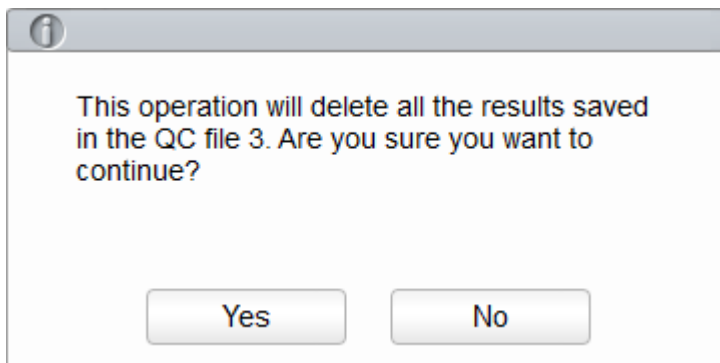

- d. Click **Yes** to delete all the QC results in the current QC file.

Print

You can print all the QC data or the data within the specified date range of the selected QC file. Detailed steps are shown below:

1. Select a QC file No. to be printed.
2. Click **Print**.

The interface pops up a dialog box as shown below.

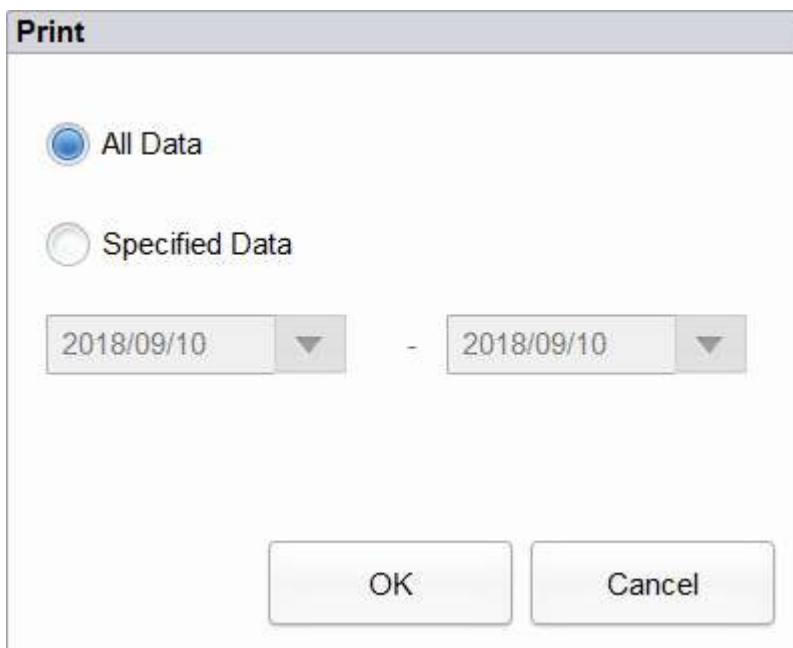

3. Select the QC data to be printed: all data or specified data.
 - When **All Data** is selected, all the QC data of the table will be printed.
 - When **Specified Data** is selected, and the date range is set in the date controls, the QC data within the specified date range will be printed.
4. Click **OK** to print the data.

Communication

NOTE

Make sure the QC settings of the LIS client and the corresponding analyser QC file is the same before communication.

The current QC data, the data within the specified date range or all the QC data can be transmitted to LIS.

- Communication for current data
 - a. Select a QC record to be transmitted, and click **Comm.**
A dialog box will pop up as shown in Figure 9-23. The default option is **Current Data**.

Figure 9-23 Communication for Current Data

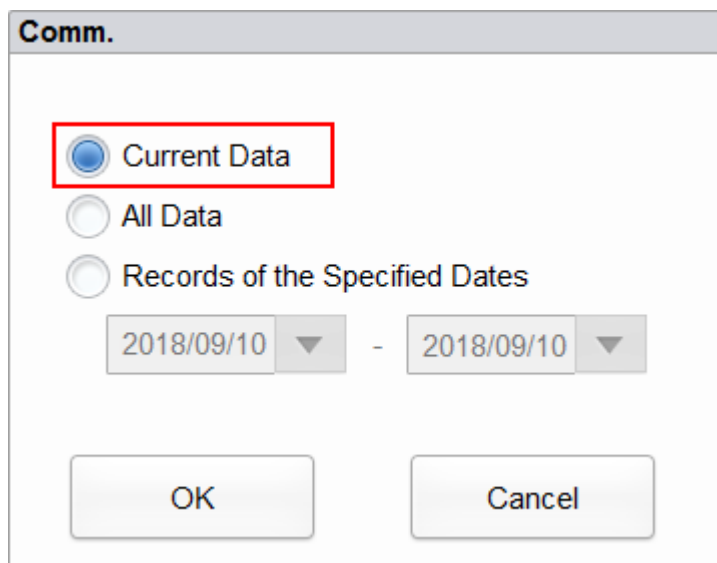

- b. Click **OK**.
After the data is transmitted to LIS, a message box as shown below will pop up.

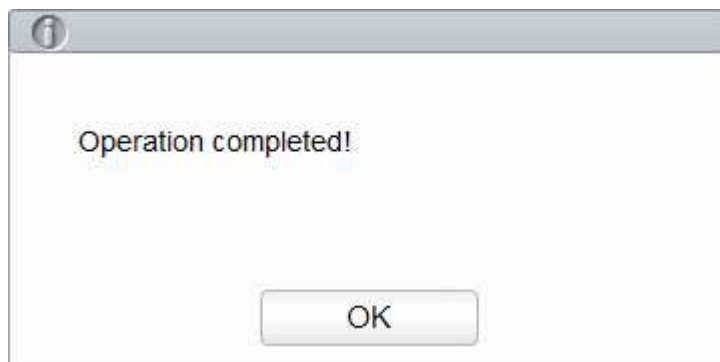

- c. Click **OK** to to close the message box.
- Communication for all data
 - a. Click **Comm.**
 - b. Select **All Data**. See Figure 9-24.

Figure 9-24 Communication for all data

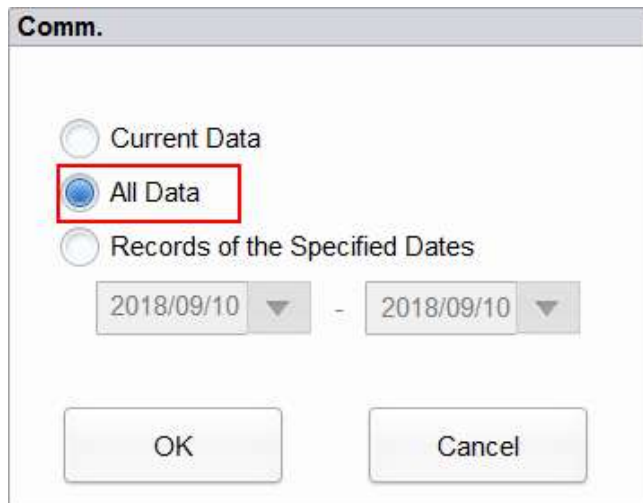

The screenshot shows a dialog box titled "Comm." with three radio button options: "Current Data", "All Data", and "Records of the Specified Dates". The "All Data" option is selected and highlighted with a red rectangular box. Below the radio buttons are two date input fields, both containing "2018/09/10" and a dropdown arrow, separated by a hyphen. At the bottom of the dialog are two buttons: "OK" and "Cancel".

c. Click **OK**.

After the data is transmitted to LIS, a message box as shown below will pop up.

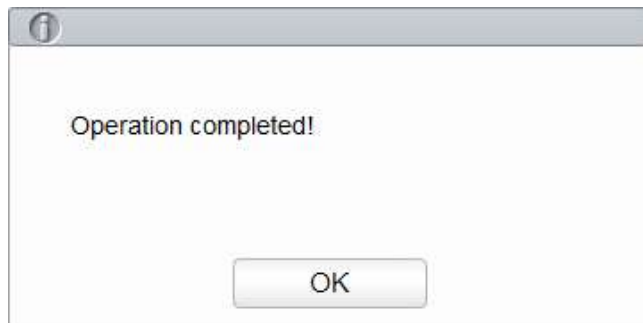

The screenshot shows a message box with a grey header bar containing an information icon. The main area contains the text "Operation completed!". At the bottom center is an "OK" button.

d. Click **OK** to close the message box.

- Transmitting the data within specified date range

a. Click **Comm..**

Select **Records of the Specified Dates**, and set the starting and ending dates for the data to be communicated.

See Figure 9-25.

Figure 9-25 Communication for the Data within the Specified Date Range

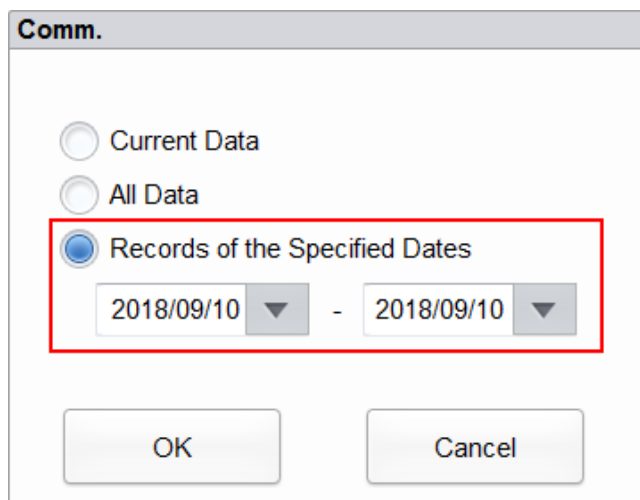

The screenshot shows a dialog box titled "Comm." with three radio button options: "Current Data", "All Data", and "Records of the Specified Dates". The "Records of the Specified Dates" option is selected and highlighted with a red rectangular box. Below the radio buttons are two date input fields, both containing "2018/09/10" and a dropdown arrow, separated by a hyphen. At the bottom of the dialog are two buttons: "OK" and "Cancel".

- b. Click **OK**.

After the data is transmitted to LIS, a message box as shown below will pop up.

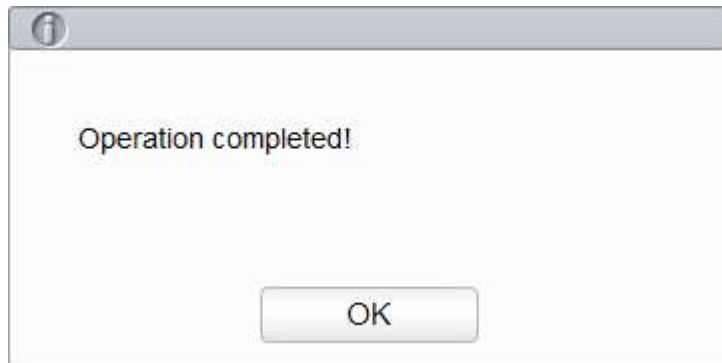

- c. Click OK to to close the message box.

Export

If you wish to export the information and the result of the current QC file, do as follows:

1. Insert a USB flash disk in the USB interface on the analyser.
2. Click **Export**.

A dialog box will pop up as shown below.

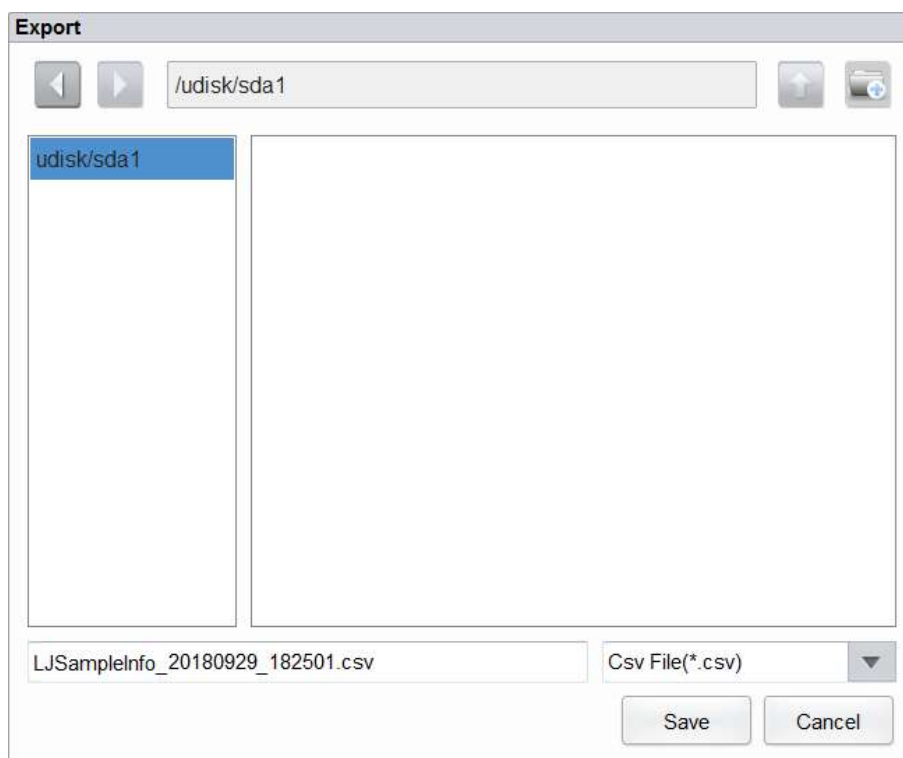

3. Select an export path for the data and enter the file name.

The file will be exported to the root directory of the USB flash disk (**/udisk/sda1**) and named in the format of **SampleInfo_yyyyMMdd_hhmmss.csv**. Among which, *yyyymmdd_hhmmss* means data export year, month, date, hour, minute, and second.

4. Click **Save**.

When the export is finished, a message box as shown below will pop up.

Figure 9-26 Export successfully

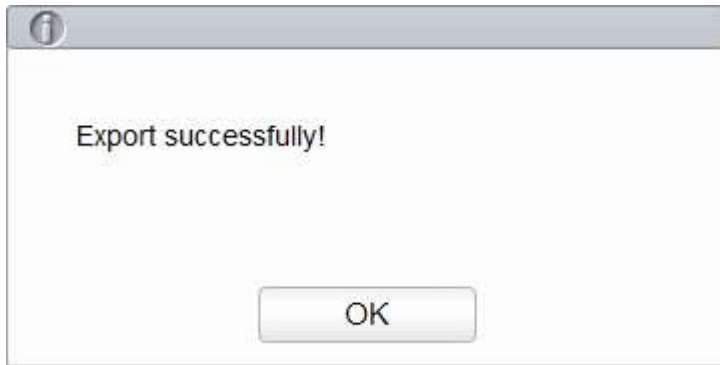

5. Click **OK** to close the message box.

10 Calibration

10.1 Introduction

Calibration is a procedure to standardise the analyser by determining its deviation, if any, from calibration references and to apply any necessary correction factors. To get accurate blood analysis results, perform calibration of the analyser following the procedures given in this chapter when it's needed.

NOTE

- Calibration procedures can only be performed by users with the administrator-level access. The login users with the access level of general users cannot perform the calibration procedures but only browse the calibration coefficients.
 - You should only use the Woodley Equipment Company-specified calibrators and reagents. Store and use the calibrator and reagents following the instructions for use of the calibrations and reagents.
 - The analyser identifies a sample as a calibration sample only if the analysis is started from the **Cal** interface.
 - The calculation of repeatability is included in the calibration procedure.
-

10.2 When to Calibrate

This analyser is calibrated at the factory just before shipment. It is electronically stable and does not require frequent recalibration if you operate and maintain it as instructed by this manual. You need to recalibrate this analyser if:

- it is the first time this analyser has been used (usually done by a Woodley Equipment Company-authorized representative when installing the analyser).
 - an analytical component has been changed.
 - the quality control results indicate that there may be a problem.
 - the operating environment (such as the temperature) has changed significantly.
-

NOTE

- All of the measured parameters must be calibrated before readings of this analyser can be used as valid analysis results.
 - For laboratories conducting routine tests, the calibration should be applied at least once every six months.
-

10.3 How to Calibrate

There are two calibration programs available on this analyser: manual calibration and auto calibration using calibrators.

All or part of the parameters of WBC, RBC, HGB, MCV and PLT can be calibrated by the calibration procedure.

10.3.1 Preparation



All the samples, controls, calibrators, reagents, wastes and areas in contact with them are potentially biohazardous. Wear proper personal protective equipment (e.g. gloves, lab uniforms, etc.) and follow laboratory safety procedures when handling them and the relevant areas in the laboratory.



WARNING

- The sample probe tip is sharp and may contain biohazardous materials. Exercise caution to avoid contact with the probe when working around it.
 - Reagents can be irritating to the eyes, skin, and mucosa. Wear proper personal protective equipment (e.g. gloves, lab uniforms, etc.) and follow laboratory safety procedures when handling them in the laboratory.
 - If the reagent accidentally comes in contact with your eyes or skin, rinse immediately with water..
 - Keep your clothes, hair and hands away from the moving parts to avoid injury.
 - Be sure to dispose of reagents, waste, samples, consumables, etc. according to local legislations and regulations.
-



CAUTION

Do not re-use disposable products including collection tubes, test tubes, capillary tubes, etc.

NOTE

- You should only use the Woodley Equipment Company-specified controls and reagents. Store and use the controls and reagents by following the instructions for use of the controls and reagents.
 - Only use Woodley Equipment Company-specified disposable products including vacutainer blood collection tube, vacutainer blood collection tubes with anticoagulant and capillary tubes etc.
-

Carry out the calibration only when the background range, repeatability and carryover are within the specified limits given in the manual, otherwise, the problems must be identified and solved before you determine if calibration is needed. If you cannot solve the problems, please contact Woodley Equipment Company Service Department.

1. Check and make sure enough reagents have been prepared for the calibration. You need to start over the calibration if the reagents run out during the process.
2. Do the background check.
If the analyser alarms are activated for abnormal background results, see **13 Troubleshooting** for solutions.(Refer to **A.4.2 Normal Background** for background range.)
3. Run the median controls in whole blood-CBC+DIFF mode consecutively for 11 times, take and view repeatability of the counting results from the 2nd run through the 11th run in the **Review** interface and make sure they are within the range specified in **A.4.4 Repeatability**.
4. Run the corresponding diluent for 3 times immediately after running the high-level controls for 3 times and calculate the carryover by the following formulae:

$$\text{Carryover (\%)} = \frac{\text{First low-value sample result} - \text{Third low-level sample result}}{\text{Third high-value sample result} - \text{Third low-level sample result}} \times 100\%$$

The calculated carryovers shall meet the requirements in **A.4.5 Carryover**.

5. It is recommended that you create a log table for your analyser. The suggested items that you may want to include in the log table are: calibration date, supplier of calibrator, lot number, expected results and limits, and result of background check.

10.3.2 Manual Calibration

Complete the manual calibration as per the following procedure:

1. Click **Cal** in the menu page to access the calibration interface.
2. Click **Manual** to access the manual calibration interface. See Figure 10-1.

Figure 10-1 Manual Calibration

Whole Blood			Predilute		
Para.	Cal. Coefficient (%)	Cal. Date	Para.	Cal. Coefficient (%)	Cal. Date
WBC	100.00		WBC	100.00	
RBC	100.00		RBC	100.00	
HGB	100.00		HGB	100.00	
MCV	100.00		MCV	100.00	
PLT	100.00		PLT	100.00	

The calibration coefficients of whole blood mode and predilute mode are displayed on the Manual interface.

NOTE

The login users with the access level of general users cannot perform the calibration procedures but only browse the calibration coefficients on the current screen. To perform the calibration, please log out and then log in as users with administrator-level access.

3. Check the calibration coefficient and calculate the new coefficient using the following equation.

$$\text{New calibration factor} = \frac{\text{Current calibration factor} \times \text{Reference value}}{\text{Mean}}$$

For example, the WBC reference value of a calibrator is 8.3, and the current calibration coefficient of the whole blood mode is 99.00%.

Run the calibrator in whole blood mode for 11 consecutive times and calculate the WBC results of the 2nd to 11th runs (n=10): The obtained CV is 1.1% and the Mean is 8.22, which meet the requirements.

The new calibration coefficient is obtained:

$$\text{New calibration factor} = \frac{99.00\% \times 8.3}{8.22} = 99.96\%$$

The calculated calibration coefficients shall be between 75%~125%. In case of an invalid calibration coefficient, try to find out the reason (e.g. calibration material not thoroughly mixed, incorrect operation, etc.). Then recalibrate the analyser and recalculate the calibration coefficients.

4. Enter the new calibration coefficients into the factor cell of the parameter that requires calibration.

NOTE

The entered calibration coefficients shall be between 75.0%~125.0% (calculation results rounded to two decimal places).

5. Click **Save**.

- If the new calibration coefficient is valid and different from the original value, the following dialog box will pop up.

Figure 10-2 Calibration set successfully

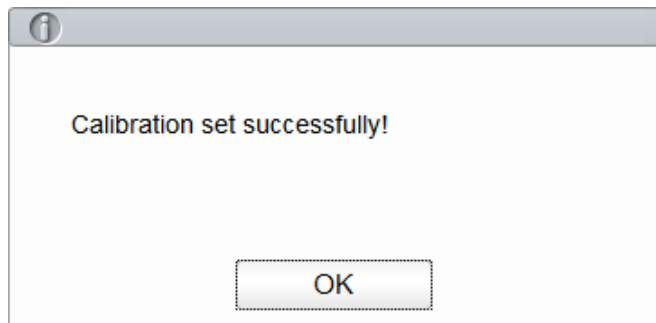

On the screen, the calibration coefficient is refreshed to be the new one and the calibration date is refreshed to be the current system date.

- If the new calibration coefficients are invalid, the message box will pop up. Click **OK** to close the message box and enter a valid factor.

Figure 10-3 Invalid Coefficients

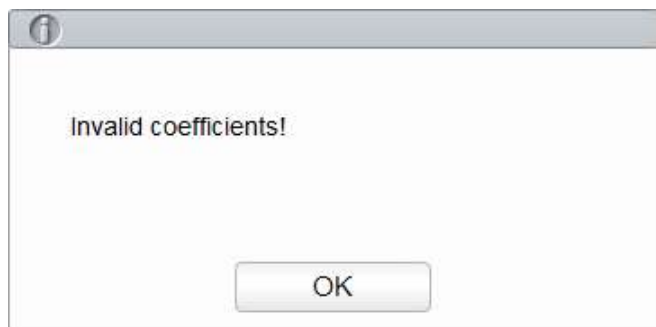

6. (Optional) Click **Print** to print the current calibration coefficient.
7. Click **Exit** to close the Manual interface.

10.3.3 Auto Calibration Using Calibrators



All the samples, controls, calibrators, reagents, wastes and areas in contact with them are potentially biohazardous. Wear proper personal protective equipment (e.g. gloves, lab uniforms, etc.) and follow laboratory safety procedures when handling them and the relevant areas in the laboratory.

NOTE

- Only Woodley Equipment Company-specified calibrators shall be used. Woodley Equipment Company will not be responsible for any erroneous result caused by using other calibrators.
- See the instructions for use of the calibrators for the lot No., Exp. Date and the target.

Complete the calibration with calibrators as per the following procedure:

1. Click **Cal** in the menu page to access the calibration interface.
2. Click **Calibrator**.

The **Calibrator** interface pops up as shown in Figure 10-4.

Figure 10-4 Auto Calibration Using Calibrators

Para.	WBC	RBC	HGB	MCV	PLT	Lot No.
Target						<input type="text"/>
<input type="checkbox"/> 1						Exp. Date
<input type="checkbox"/> 2						2018/09/29 <input type="button" value="v"/>
<input type="checkbox"/> 3						Mode
<input type="checkbox"/> 4						<input checked="" type="radio"/> Whole Blood
<input type="checkbox"/> 5						
<input type="checkbox"/> 6						
<input type="checkbox"/> 7						
<input type="checkbox"/> 8						
<input type="checkbox"/> 9						
<input type="checkbox"/> 10						
Mean						<input type="button" value="Clear"/>
CV(%)						<input type="button" value="Print"/>
New Calibration Coefficient (%)						<input type="button" value="Save"/>
Original Calibration Coefficient (%)	100.00	100.00	100.00	100.00	100.00	

3. Enter the lot No. of the calibrator into the Lot No. box.
4. Click the **Exp. Date** box, and then edit the **Exp. Date**.

NOTE

- The **Exp. Date** can be no earlier than the current system date.
- The entered **Exp. Date** should be either the **Exp. Date** printed on the labelling or the open-container expiration date, whichever is earlier. The open-container expiration date is calculated as: the date on which the container is opened + the open-container stability days.

5. Input the target values of the parameters in the corresponding cell of the **Target**.
6. Prepare the calibrators following their instructions for use and place the calibrators under the sampling probe.
7. Press the aspirate key to start the calibration counting.

After every calibration run, the progress bar will close automatically and the analyser will have different responses according to different analysis results.

- The valid results within the linearity range will be displayed directly.
- If the calibration counting data of any parameter in the current counting are out of the display range or linearity range of the parameter, a message box will pop up on the screen prompting that the calibration data is invalid.

Click **OK** to close the message box and delete the data from the table without saving.

- If any of the parameter's value in the calibration counting differs from the Target value by more than 50%, the system will prompt you with a message box asking if the calibration counting results should be kept.

To keep the results, click **Yes**; to remove the results, click **No**.

NOTE

- After the valid calibration result is obtained, the parameters with corresponding checkboxes ticked off will be involved in the calculation of the calibration coefficients by default.
- If you switch to other interfaces before the new calibration coefficients are obtained, the system will discard the current calibration data and keep the original calibration coefficients.

8. To get 10 valid counting results, repeat steps 6~7 ten times.

The analyser will, by default, calculate the Mean, CV% and the new calibration coefficients based on all the ticked-off calibration data according to the formulae.

9. Select at least 5 groups of data for the calculation of the calibration coefficients.

When the amount of the valid calibration data in the list reaches 10, a message box of **Calibrator calibration done!** will pop up. Click **OK** to close the message box.

If the calibration coefficients are invalid, click **Yes** to close the dialog box. Then click **Clear** to delete the current data and redo the calibration.

NOTE

The out-of-range CV% does not influence the display of the calibration coefficients.

10. Click **Save**.

- If the calculated calibration coefficients of all parameters are within the range of 75%~125% and the CV% of all parameters are also within the repeatability, then a dialog box prompting the successful calibration setting will pop up. Click **OK** to close the message box.

- If the obtained calibration coefficient of any parameter is not within the range of 75%~125% or the CV% of any calibrated parameter does not meet the repeatability, the calibration coefficient will not be saved and a dialog box indicating invalid new calibration coefficient will pop up. Click **Yes** to close the dialog box and repeat the calibration operations.

11. (Optional) Click **Print** to print the calibration results.

10.4 Verifying Calibration Coefficients

It is recommended that you take the following steps to verify the calibration coefficients:

1. Run the calibrator at least three times and check whether the means of the obtained results are within the expected ranges.
2. Run the low-, normal- and high-level controls each for three times at least, and check whether the means of the obtained results are within the expected ranges.
3. Run at least three fresh blood samples with known reference values, each for six times at least, and check whether the means of the obtained results are within the expected ranges.

11 Reagent Management

Once the new reagent is connected to the analyser, you can set the reagent configurations, including validity period, residue volume and reagent barcode on the Reagent Management interface. Upon the completion of reagent configuration, you can perform the procedures for reagent replacement.



WARNING

- Reagents can be irritating to the eyes, skin, and mucosa. Wear proper personal protective equipment (e.g. gloves, lab uniforms, etc.) and follow laboratory safety procedures when handling them in the laboratory.
- If the reagent accidentally comes in contact with your eyes or skin, rinse immediately with water.

NOTE

- After long-distance transportation, the reagent must be allowed to settle for more than one day before use.
- When you have changed the diluents, cleansers or lyses, run a background check to see if the results meet the requirement.

11.1 Accessing the Interface

Click **Reagent Management** in the menu navigation area, to access the reagent management setting interface. See Figure 11-1.

Figure 11-1 Reagent Management

Reagent Name	Exp. Date	Open-container Date	Period After Opening	Open-container Exp. Date	Residue Volume
V5 DIL Diluent					
V5 LY1 Lyse					
V5 LY2 Lyse					

Refer to Table 11-1 for related parameter descriptions.

Table 11-1 Parameter Description for Reagent Management

Parameter	NOTE
Current Model	<p>Current model of the analyser.</p> <ul style="list-style-type: none"> • Open system • Closed system <p>Reagent setting procedures for different analyser models vary, please refer to 11.2 Setting Reagent Information.</p>
Reagent Name	Name of the reagent.
Exp. Date	<p>Exp. Date of the unopened reagent will be shown upon the completion of the reagent settings.</p> <p>Any reagent, regardless of its container being opened or not, should not be used beyond this date.</p>
Open-container Date	The date on which the reagent container is opened. The default open-container date is the date on which the reagent settings are completed.
Period after opening (PAO)	The validity period (days) after the reagent container is opened. It will be shown upon the completion of the reagent settings.
Open-container Exp. Date	Expiration date of the opened reagent, and it will be shown upon the completion of the reagent settings.
Residue Volume	The current residue volume of the reagent, and it will be shown in ml upon the completion of the reagent settings. The unit is ml.

11.2 Setting Reagent Information

Once the new reagent is connected to the analyser, you should set the reagent configurations, including validity period, residue volume and reagent barcode on the **Reagent Management** interface. Upon the completion of reagent configuration, you can perform the procedures for reagent replacement.

Reagent setting procedures for different analyser models vary. The reagent setting procedures for both open and closed models will be presented on the following pages.

11.2.1 Open system

For open systems, reagent setting procedures are as follows:

1. Select the reagent to be set , and then click **Setup**.

This launches the **Reagent Information** page as shown in Figure 11-2.



Figure 11-2 Reagent Information

2. To enter the reagent information, use any of the following methods.

➤ Manual Entry

Detailed parameter description is shown in Table 11-2.

Table 11-2 Parameter Description of Reagent Information

Parameter	It means	Operation
Reagent Name	Name of the reagent to be set.	Input in the textbox directly.
Exp. Date	The expiration date of the unopened reagent (see the outer packaging of the reagent). Any reagent, regardless of its container being opened or not, should not be used beyond this date.	<p>Click the date control for the settings.</p> <ul style="list-style-type: none"> The input sequence of the controls is year, month, and date. Click  or  to select a date and time or enter the information in the textbox directly. Click  to clear the current data and re-enter the information. <p>NOTE</p> <p>The validity date of the reagent can be no later than the validity date indicated on the packaging and cannot be earlier than the current system date.</p>
Period after opening (PAO)	The validity period (days) of the open-container reagent (see the product packaging).	Input in the textbox directly.
Residue Volume	The current residue volume of the reagent (ml).	Input in the textbox directly.

- Manually input the reagent barcode, and click Load; or input the barcode via a peripheral barcode scanner.

A correctly entered barcode will prompt a message shown below the barcode box, indicating a successful loading, and the validity date and residue volume will be shown in the corresponding textboxes.

If the barcode fails load, check if the reagent has been used or has expired and the reagent name is correct. If all the information is correct, but the failure persists, please contact Woodley Equipment Company Technical Support.

3. Click **Apply**.

The system message will pop up, indicating the successful reagent settings.

Figure 11-3 Successful Reagent Settings

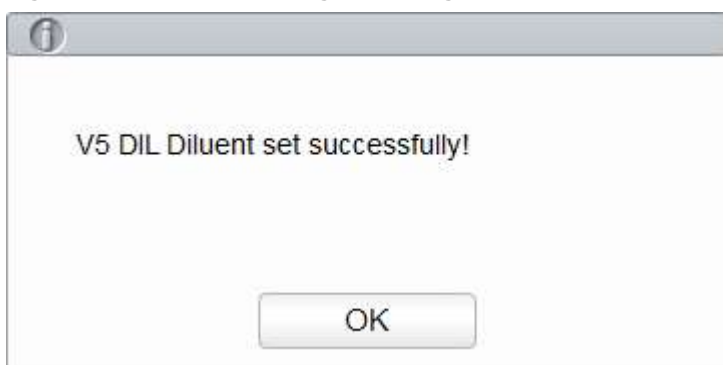

4. Click **OK**.
5. Continue to perform 1~4 and set the other reagent information; or click  to exit the setting interface.

NOTE

Once the reagent settings are successfully completed, the system prompt at the top right corner of the screen will show that the reagent has not been replaced. To remove this error, click the error message and then click **Remove Error** in the pop-up dialog box. The analyser will complete the replacement of the reagent and remove the error.

11.2.2 Closed system

There are two types of reagents for the closed system: open reagents and closed reagents.

- For open reagents, see the settings of the open system in 11.2.1 Open system.
- For closed reagents, the reagent setup is disabled normally. The setup is only required when the Insufficient reagent error is prompted.

Taking **Insufficient V5 LY1** as an example, this section introduces the setting procedures for the closed reagent.

1. When the **Insufficient V5 LY1** is prompted on the upper right of the screen, double click the message.
2. Select the error name in the popup dialog box, and click **Remove Error**.

A dialog box as shown in Figure 11-4 pops up.

Figure 11-4 RF Card Verification

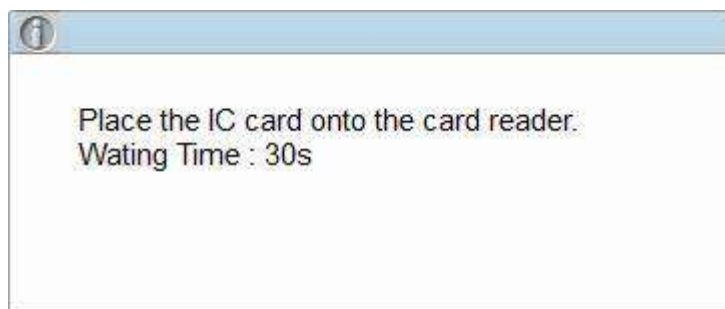

- Put the RF card attached to reagent packing on the RF card reader in front of the analyser. The beeping of the card reader and a pop-up dialog box as shown in Figure 11-5 indicate the successful reagent settings.

Figure 11-5 Successful Reagent Settings

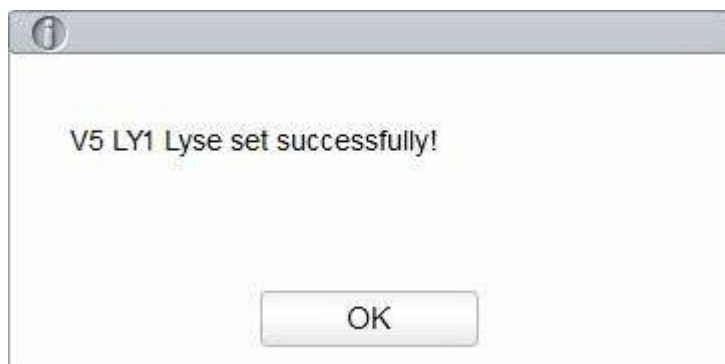

NOTE

- The RF card is intended for single use only.
- If RF card verification fails, please follow the system prompts and use a valid RF card for re-reading.

- Click **OK**.
- Click **Close** to exit.

NOTE

Once the reagent settings are successfully completed, the system prompt at the top right corner of the screen will show that the reagent has not been replaced. To remove this error, click the error message and then click **Remove Error** in the pop-up dialog box. The analyser will complete the replacement of the reagent and remove the error.

11.3 Replacing Reagents

After completing the reagent settings, you should perform the reagent replacement operations. You can select to replace one type of reagent at a time or all reagents. The method is applied as follows:

1. Select a type of reagent to be replaced, and click Replace; or click Replace All to replace all the reagents.

After the replacement is completed, a message box as shown below will pop up on the screen.

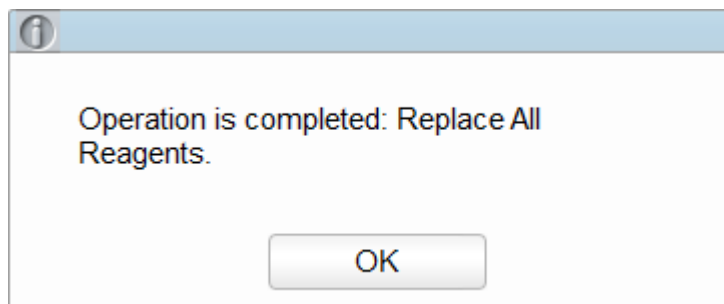

2. Click **OK** to close the message box.

NOTE

When you have changed the reagents, run a background check to see if the results meet the requirement.

12 Service

12.1 Introduction

This analyser provides multiple maintenance functions for this purpose. This chapter introduces how to use the provided functions to maintain and troubleshoot your analyser. Preventive and corrective maintenance procedures are required to keep the analyser in a good operating condition.



All the analyser components and surfaces are potentially infectious, take proper protective measures for operation or maintenance.



CAUTION

- Performing unauthorised maintenance procedures can damage your analyser. Do not perform any maintenance procedures that are not described in this chapter.
 - In case of problems not specified in this manual, contact Woodley Equipment Company customer service department or your local agent for assistance.
 - Only Woodley Equipment Company-supplied parts can be used for maintenance. If you have a question, contact Woodley Equipment Company customer service department or your local agent.
 - Exercise caution to avoid contact with the sharp sample probe when performing maintenance.
-

12.2 Maintenance

The analyser provides multiple service functions helping users to perform daily maintenance.

12.2.1 Reagent Replacement



WARNING

- Reagents can be irritating to the eyes, skin, and mucosa. Wear proper personal protective equipment (e.g. gloves, lab uniforms, etc.) and follow laboratory safety procedures when handling them in the laboratory.
 - If the reagent accidentally comes in contact with your eyes or skin, rinse immediately with water.
-

NOTE

- After long-distance transportation, the reagent must be allowed to settle for more than one day before use.
- When you have changed the diluents, cleansers or lysers, run a background check to see if the results meet the requirement.

You should replace the reagents when:

- The system indicates that the reagent is used up
- The suspicious flag indicates that the reagent in the pipeline is contaminated
- The reagent is contaminated or expired
- WBC or RBC bubbles are identified.

You can replace any of the following reagents:

- V5 DIL Diluent
- V5 LY2 Lyse
- V5 LY1 Lyse

Do as follows to replace the reagents:

1. Refer to Figure 2-2 in **2.6.2 Reagent Connections** for reagent connections.
2. Click the **Service** icon in the menu page to access the **Service** interface as shown in Figure 12-1.

Figure 12-1 Service

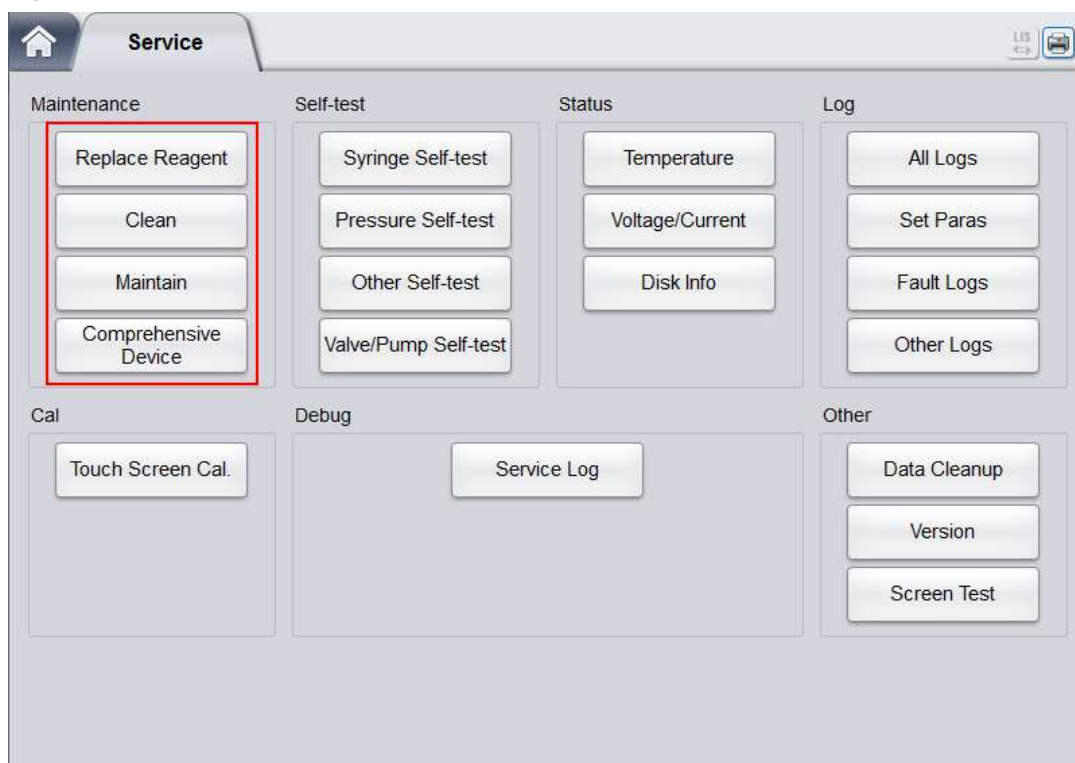

3. Click **Replace Reagent** in the **Maintenance** selection.
The interface as shown in Figure 12-2 will pop up on the screen.

Figure 12-2 Reagent Replacement



4. Click the name of the reagent that needs to be replaced, such as **Replace All Reagents**. After the replacement is completed, the following message box will pop up.

Figure 12-3 Reagent Replaced

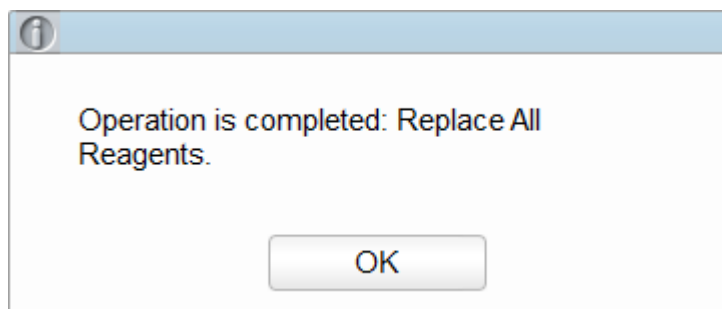

5. Click **OK** to close the message box.
6. Perform the above procedures to replace other reagents if necessary.

12.2.2 Cleaning

Clean corresponding parts according to the actual situation:

- WBC bath

You should clean the WBC bath when:

- the background of the scattergram has abnormal excessive cells
- the background of WBC- and/or HGB-specific parameters exceeds the reference range

- RBC bath

When the background of RBC- and (or) PLT-specific parameters exceeds the reference range, you should clean the RBC bath.

- Flow chamber

When the background of the scattergram has abnormal excessive cells, or bad differential of WBC, you should clean the flow chamber.

- Sample probe

When the sample probe is dirty, you should clean the sample probe.

The cleaning procedures are as follows:

1. Click the **Service** icon in the menu page to access the **Service** interface.

Figure 12-4 Service

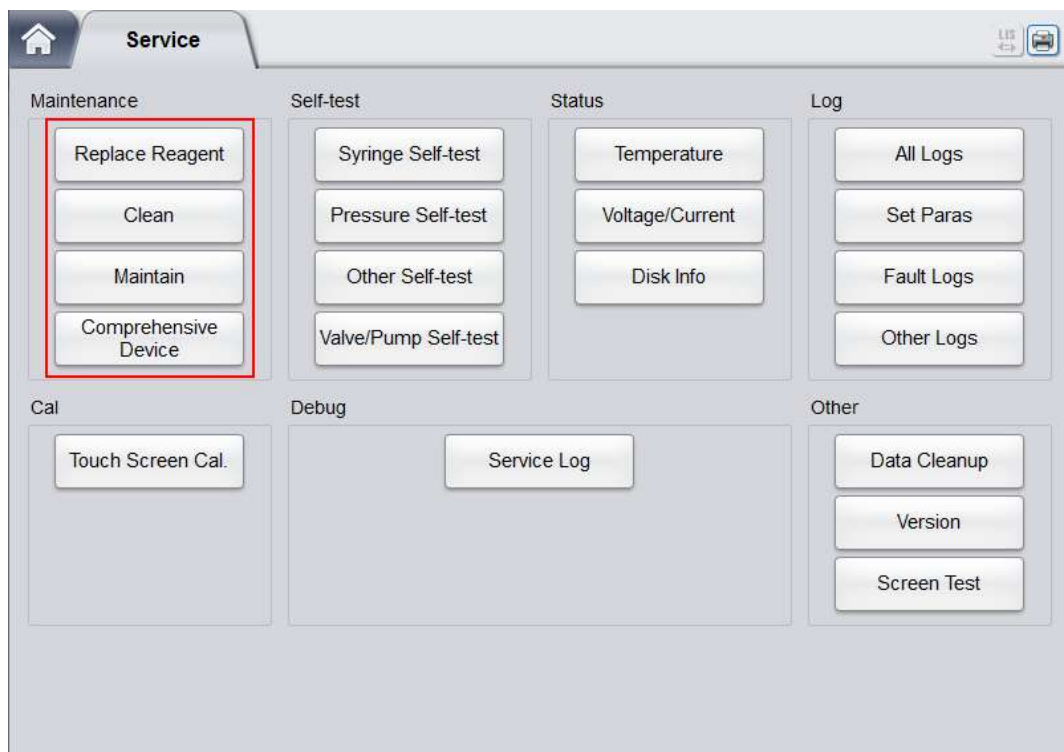

2. Click **Clean** in the **Maintenance** selection, an interface as shown in Figure 12-5 will pop up on the screen.

Figure 12-5 Cleaning

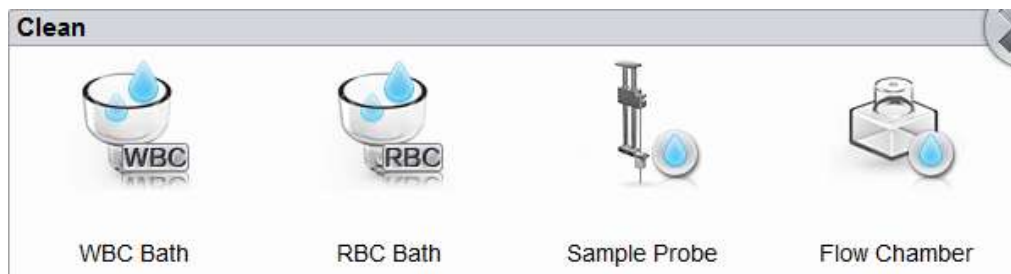

3. Click the icon of the part that needs to be cleaned, such as **Sample Probe**.
When the system cleaning is complete, the message box will pop up to show that the cleaning is done.

Figure 12-6 Cleaning Done

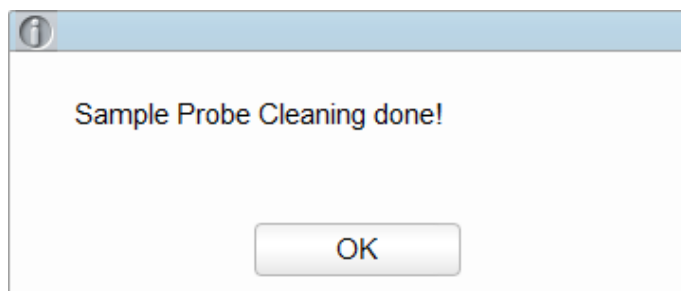

4. Click **OK** to close the message box.
5. Perform the above procedures to clean other components if necessary.

12.2.3 Maintenance

Maintenance of the analyser includes: unclogging, cleanser soak, cleanser soak for WBC channel, and cleanser soak for RBC channel.

12.2.3.1 Unclogging

If clogging is found, or it is suspected that the counting results are not accurate due to aperture clogging, you can perform the unclogging operations.

The unclogging procedures are shown as follows:

1. Click the **Service** icon in the menu page to access the **Service** interface.

Figure 12-7 Service

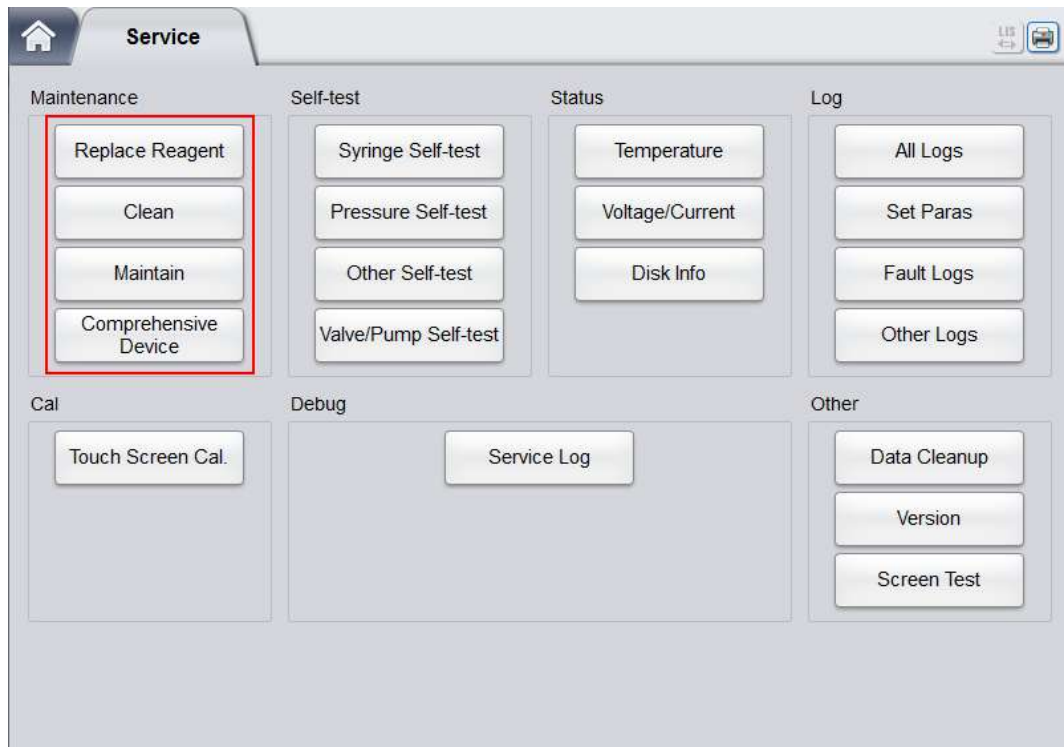

2. Click **Maintain** in the **Maintenance** selection.

The interface as shown in Figure 12-8 will pop up on the screen.

Figure 12-8 Maintenance



3. Click the **Unclog** icon.

The system will start unclogging, and a message box will pop up. After the unclogging is completed, a message box will pop up to show that the clogging is done.

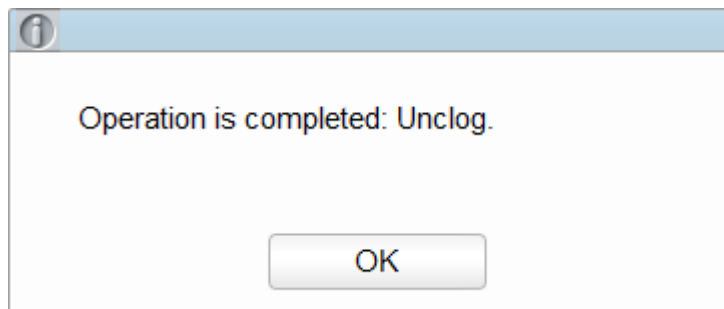

4. Click **OK** to close the message box.
5. Perform the above procedures to continue unclogging if necessary.

12.2.3.2 Cleanser Soak

The cleanser soak should be performed under the following circumstances:

- When the problems including the background results exceed the Ref. Range, bad differential of scattergram and clogging still exist after other maintenance procedures have been adopted.
- Analyser has been running for more than 24 hours.

The cleanser soak procedures are shown as follows.

1. Click the **Service** icon in the menu page to access the **Service** interface.

Figure 12-9 Service

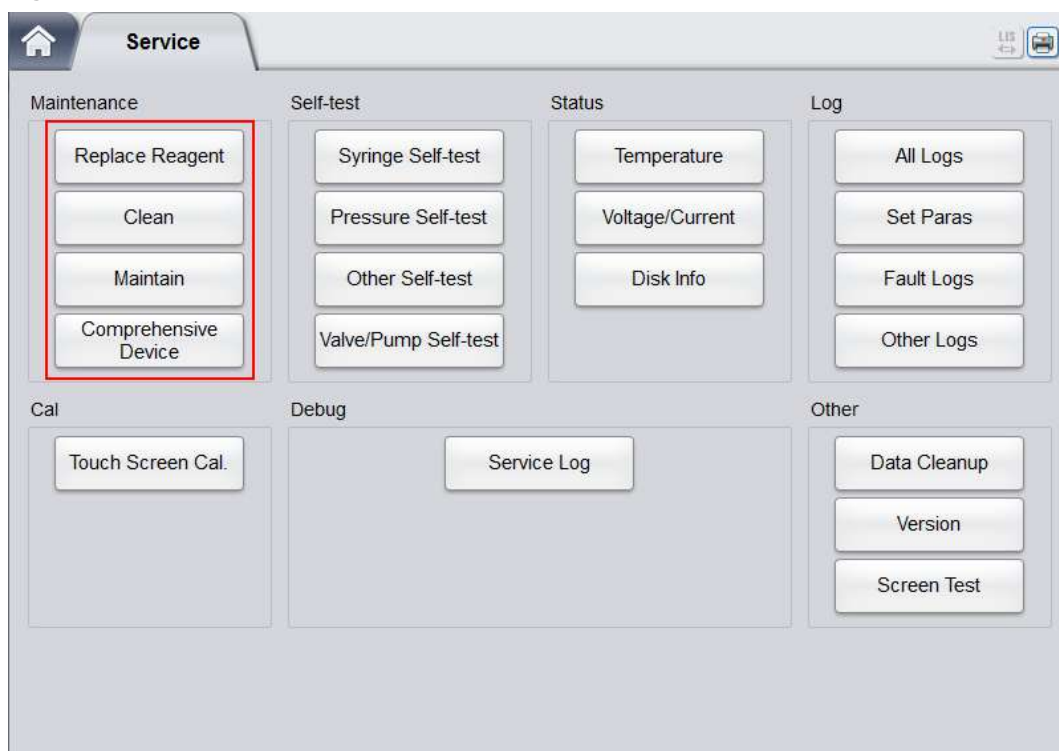

2. Click **Maintain** in the **Maintenance** selection.

The interface as shown in the following picture will pop up on the screen.



3. Click the icon of **V5 CLE Cleanser Soak**.

A dialog box as shown below will pop up.

Figure 12-10 Cleanser Soak

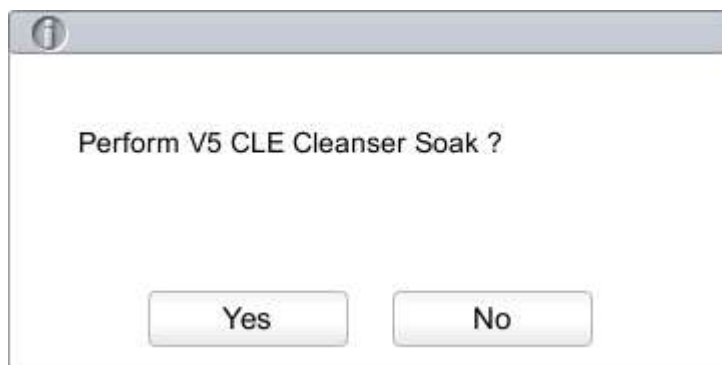

4. Click **Yes**.

A dialog box as shown below will pop up.

Figure 12-11 Cleanser Soak Prompt

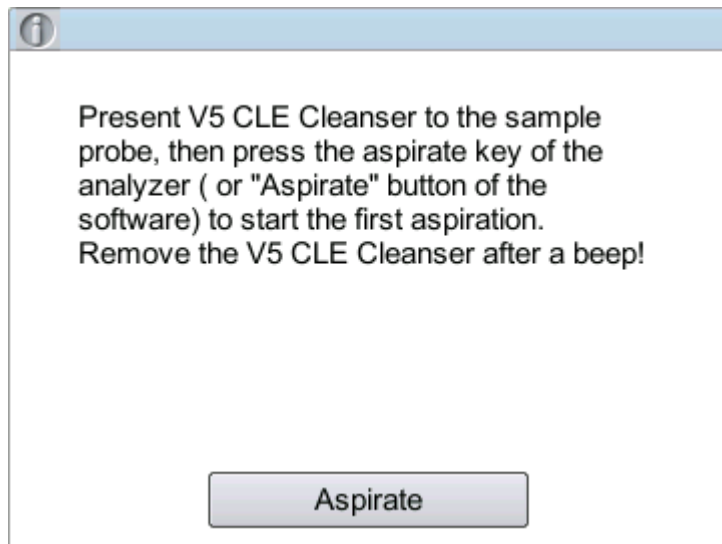

5. Present the cleanser to the sample probe as per the prompt, and press the aspirate key or click the **Aspirate** button.

Soaking V5 CLE Cleanser... and the soaking time will appear as shown in See Figure 12-12.

Figure 12-12 Cleanser Soaking Process Prompt

After one minute of soaking, you can stop it manually.

6. Click the **Stop soaking** button, or wait for 19 minutes until the automatic soaking is completed. After the soaking is completed, a prompt **V5 CLE Cleanser Maintenance done!** appears. See Figure 12-13.

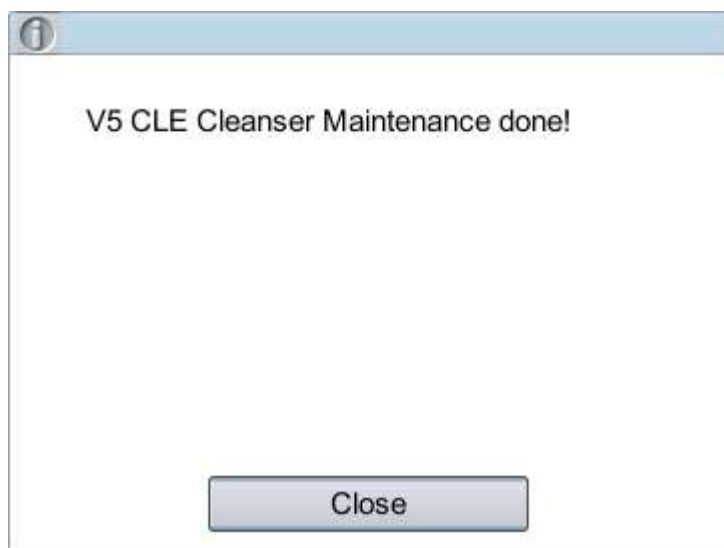
Figure 12-13 Cleanser Maintenance Done

7. Click **Close**.
8. Perform the above procedures to perform the cleanser soak again if necessary.

12.2.3.3 Cleanser Soak for WBC Channel

Probe cleanser soaking for WBC channel can be used to remove the errors for aperture clogging or abnormal scattergram. Please refer to **12.2.3.2 Cleanser Soak** for performing the operations for cleanser soaking for WBC channel.

12.2.3.4 Cleanser Soak for RBC Channel

In case the RBC distribution histogram is abnormal or the clogging is believed to exist in the flow chamber, cleanser soak for RBC channel feature can be used as a means for troubleshooting. Please refer to **12.2.3.2 Cleanser Soak** for performing the operations for cleanser soaking for WBC channel.

12.2.4 Comprehensive Device Maintenance

The comprehensive device maintenance feature includes fluidics initialisation, comprehensive device cleaning, emptying fluidics and preparing to ship.

12.2.4.1 Fluidics Initialisation

After maintaining the fluidic system or replacing a main part of the analyser, you should perform this procedure to initialise the fluidic system.

Do as follows to perform the fluidics initialisation:

1. Click the **Service** icon in the menu page to access the **Service** interface.

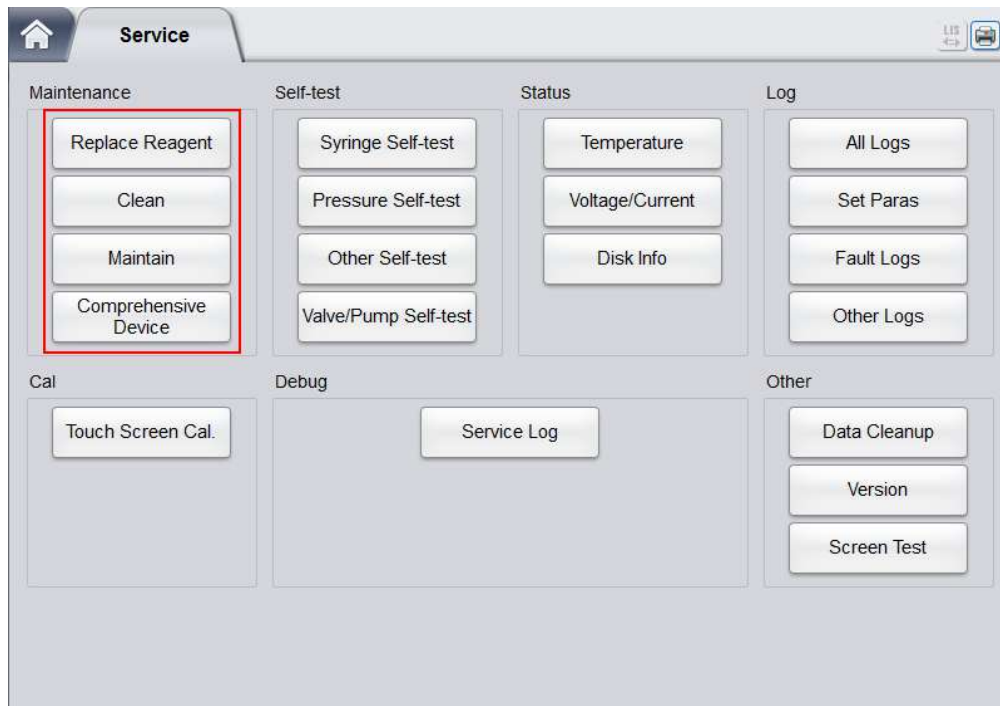

2. Click **Comprehensive Device** in the **Maintenance** selection.

The interface as shown below will pop up on the screen.

Figure 12-14 Comprehensive Device Maintenance



3. Click the icon of **Fluidics Initialisation**.

The analyser starts to perform the fluidics initialisation procedure. After the initialisation is complete, a message box will pop up.

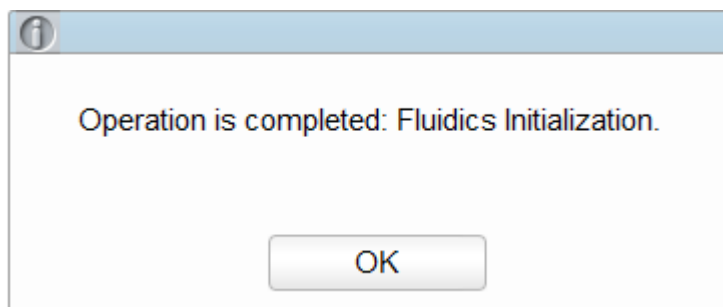

4. Click **OK**.

12.2.4.2 Clean Fluidics

If the background results of parameters are out of the background range, the comprehensive device cleaning should be cleansed.

Procedures for comprehensive device cleaning are shown as below:

1. Click the **Service** icon in the menu page to access the **Service** interface.
2. Click **Comprehensive Device** in the **Maintenance** selection.

The interface as shown below will pop up on the screen.

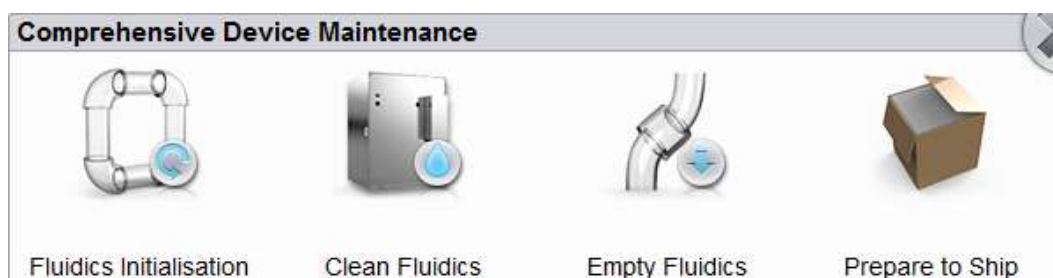

3. Click **Comprehensive Device** in the **Maintenance** selection.

The analyser starts to perform the fluidics cleaning procedure. After the cleaning is completed, the following message box will pop up.

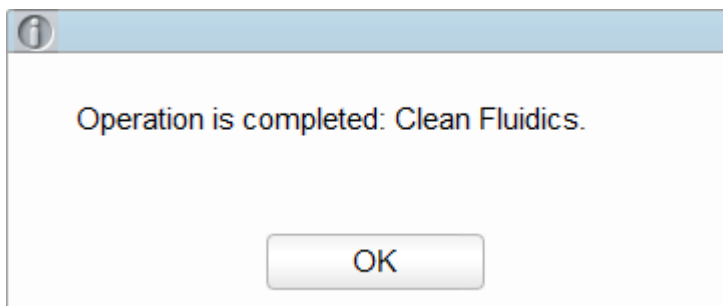

4. Click **OK**.

12.2.4.3 Empty Fluidics

This function enables the device to empty fluidics to prevent crystallisation and maintain device performance when the device has not been used for more than one week.

Procedures for emptying fluidics are shown as below:

1. Click the **Service** icon in the menu page to access the **Service** interface.
2. Click **Comprehensive Device** in the **Maintenance** selection.

The interface as shown below will pop up on the screen.

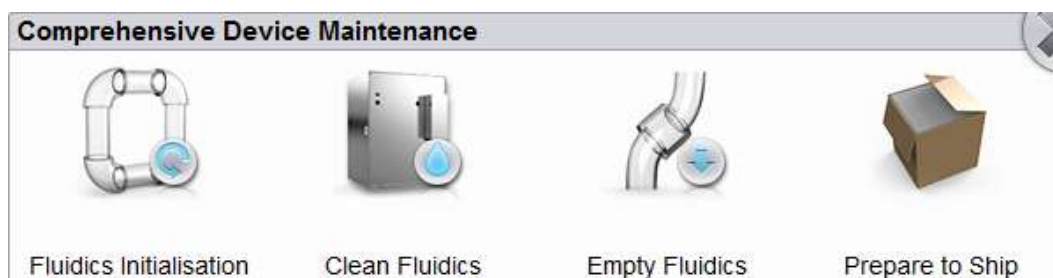

3. Click the icon of Empty Fluidics.

A dialog box will pop up as shown below.

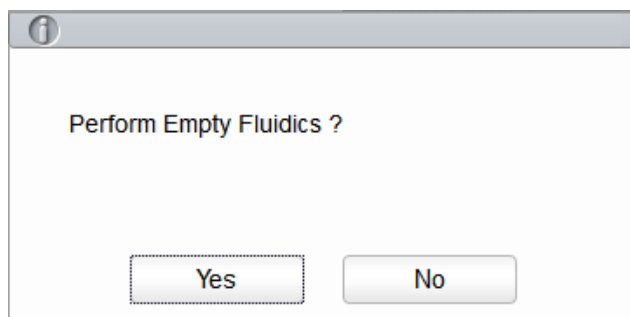

4. Click **Yes**.

A dialog box will pop up as shown below.

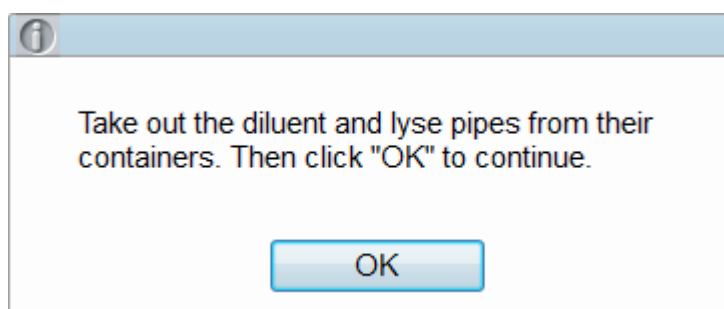

5. Remove all reagent pickup tube assemblies according to the prompt, and then click **OK** to start emptying the fluidic system.

After the emptying is complete, a message box will pop up.

Empty Fluidics done. Please power off the analyser!

6. Place the [O/I] switch at the left side of the main unit in the [O] position.

7. After shutdown, empty the waste in the waste container, and dispose of it.

WARNING

Be sure to dispose of reagents, waste, samples, consumables, etc. according to local legislations and regulations.

12.2.4.4 Prepare to Ship

If the analyser will not be used for over two weeks or needs be transported over a long distance (transporting time > 2h), you should perform this procedure.

Do as follows to perform the prepare-to-ship procedure:

1. Click the **Service** icon in the menu page to access the **Service** interface.
2. Click **Comprehensive Device** in the **Maintenance** selection.

The interface as shown below will pop up on the screen.



3. Click the icon of **Prepare to Ship**.

A dialog box will pop up as shown below.

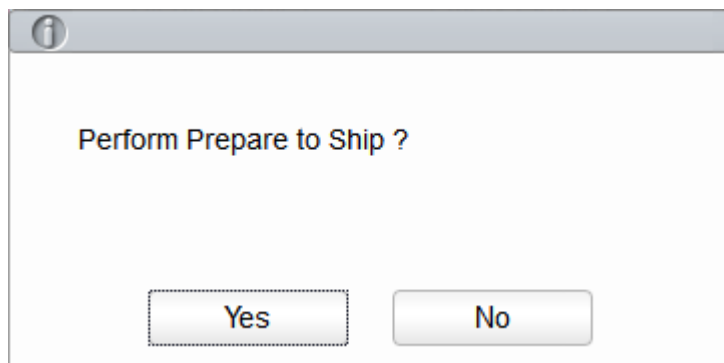

4. Click **Yes**.

The interface pops up a dialog box as shown below.

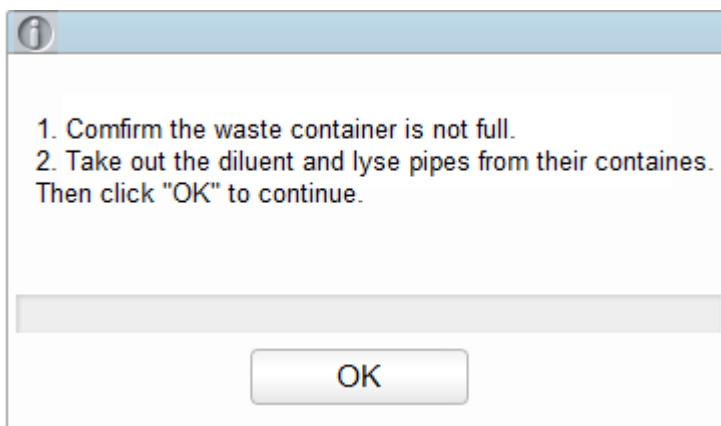

5. Remove all reagent pickup tube assemblies according to the prompt, and then click **OK** to start emptying the fluidic system.

After the emptying is complete, a message box will pop up.

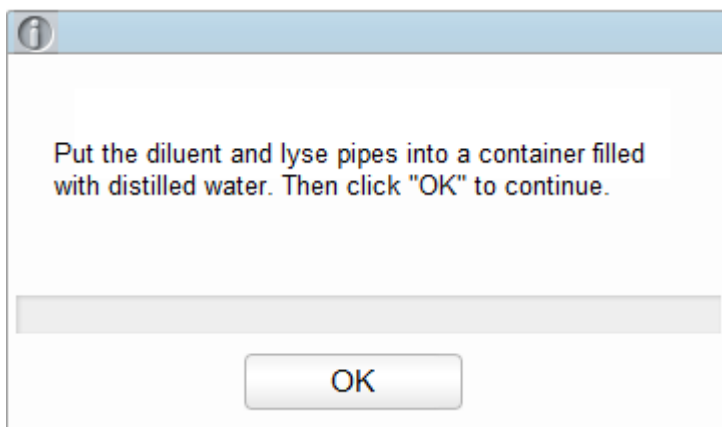

6. Place all reagent pickup tube assemblies into the distilled water, and then click **OK** to start priming.

NOTE

- Be sure to use distilled water in order to ensure the normal use of the device in the future. In addition, the beaker holding the distilled water needs to be cleaned thoroughly.
 - The diluent pipe and lyse pipes should be stored separately in two beakers.
-

System performs the filling operation. After the filling is completed, the following dialog box will pop up.

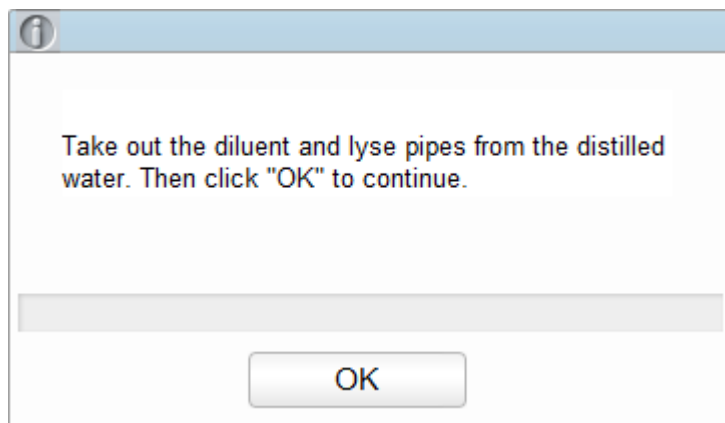

7. Take out the diluent and lyse pipes from the distilled water as per the prompt, then click **OK**. A dialog box will pop up to prompt you to power off the device.

Prepare to Ship done. Please power off the analyser!

8. Place the [O/I] switch at the left side of the main unit in the [O] position.
9. After shutdown, empty the waste in the waste container, and dispose of it.



WARNING

Be sure to dispose of reagents, waste, samples, consumables, etc. according to local legislations and regulations.

12.2.5 Auto Clean

There will be a certain amount of contamination accumulated after running a certain amount of samples without shutting down the analyser. When the sample count amounts to over 100, the analyser will perform the cleaning procedure automatically once, and a prompt will be displayed on the screen.

In addition, the analyser will perform the auto clean procedures if there has been no fluidics sequential operation for more than one hour.

NOTE

Once the auto clean is performed or the analyser is shut down, the statistical data of auto clean will be cleared automatically.

12.2.6 Auto Prompt for Cleanser Soak

If the analyser has been running for more than 24 hours but hasn't performed cleanser maintenance when the auto maintenance time is reached, the system will prompt to perform cleanser soak immediately, so as to prevent the accumulation of contamination.

- Click **Yes**, then you can perform the cleanser maintenance as per the prompt and the description in 12.2.3.2 Cleanser Soak.
- Click **No**, then the system will remind you every 10 minutes until you perform the maintenance.

NOTE

- At the **Self-test** or **Status** interface, the analyser does not ask for confirmation to perform the cleanser soak.
- If the analyser is running or has problems when the conditions of auto prompt for cleanser soak is satisfied, the analyser will prompt again after the current operation is completed or the problems are resolved.
- After cleanser soak is completed, the accumulative count values will be cleared automatically.
- Cleanser soak is an important step in comprehensive device maintenance. It is recommended not to stop soaking halfway.

12.2.7 Auto Sleep

When the fluidics system stops working for a specified waiting time for auto sleeping (30 minutes by default), the analyser will enter the sleeping status automatically.

- Press the aspirate key on the analyser to start up.
- Touch the screen to enter the user interface. A prompt is displayed in the lower left corner of the user interface indicating that the analyser is in sleep mode. See Figure 12-15.

Figure 12-15 Sleep Tips

Sleeping mode. Click the aspirate key to wake up!

You can perform other operations except sequence actions.

NOTE

- If it is the time to auto sleep but the analyser is error status, then only after the error is removed will auto sleep start accordingly.
- Different maintenances will be performed by the analyser automatically when exiting the sleep mode, and the exiting time depends on how long the analyser was in the sleep mode.
- If errors occur when you are trying to cancel the auto sleep of the analyser, please refer to **13 Troubleshooting** for solving the problems.
- You can change the waiting time for auto sleeping as needed, see **5.3.4 Auto Maintenance**.

12.3 Self-test

This feature is to test if some important components of the device can function properly or not, including syringe and sampling assembly self-test, pressure and vacuum self-test, valve self-test and other self-test.

NOTE

If the testing result is abnormal, you should try again for several times; if the abnormalities persist, please contact Woodley Equipment Company customer service department or your local agent.

12.3.1 Syringe and Sampling Mechanism

You can test the performance of all syringes and sampling mechanisms.

The self-inspection procedures are shown as below:

1. Click the **Service** icon in the menu page to access the **Service** interface.
2. Click **Syringe Self-test** in the **Self-test** selection.

The interface as shown in Figure 12-16 will pop up on the screen.

Figure 12-16 Syringe



3. Click the part that needs to be tested, e.g. **Sampling Syringe**, and wait for the self-inspection results.

After the self-test is completed, a dialog box will pop up to show the self-test results.

Figure 12-17 Syringe Self-test Results

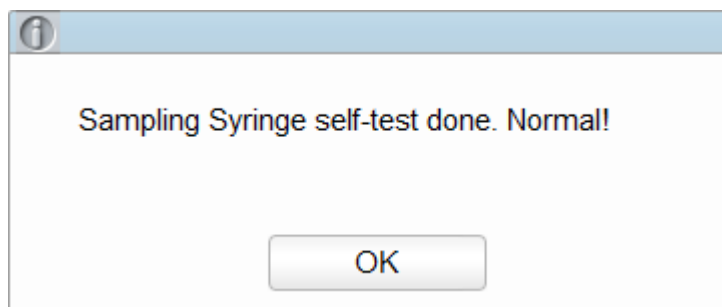

4. Click **OK** to close the message box.

12.3.2 Pressure and Vacuum

This feature is to test the pressure and vacuum inside the device.

Procedures for pressure (or vacuum) self-inspection are shown as below:

1. Click the **Service** icon in the menu page to access the **Service** interface.
2. Click **Pressure Self-test** in the **Self-test** selection.

The interface as shown in Figure 12-18 will pop up on the screen.

Figure 12-18 Pressure and Vacuum Self-inspection



3. Click **Pressure** (or **Vacuum**).

The system will perform the corresponding self-test operations. After the self-test is completed, a dialog box will pop up to show the self-test results.

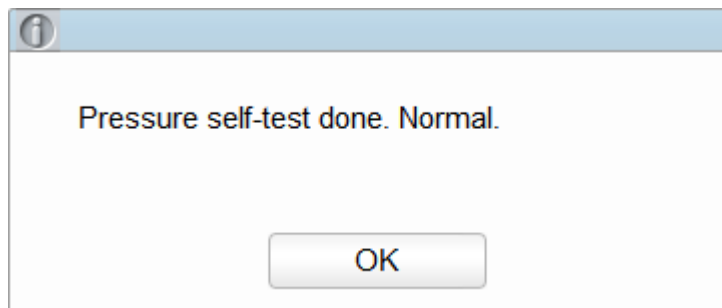

4. Click **OK** to close the message box.

12.3.3 Valve & Pump

When controlling the switches of different valves (pumps), you can judge if the valves (pumps) are operating properly by the sound of opening, closing or manually touching the corresponding valves (pumps).

The procedures for valve self-inspection are shown as follows:

1. Click the **Service** icon in the menu page to access the **Service** interface.
2. Click **Valve/Pump Self-test** in the **Self-test** selection.

The interface as shown in Figure 12-19 will pop up on the screen.

Figure 12-19 Valve/Pump Self-test



3. Click the desired valve number (e.g. **1**), then confirm whether it works properly by the sound of its opening and closing.

12.3.4 Others

You can perform the self-test for RBC aperture voltage.

RBC Aperture Voltage

The self-test procedure of RBC aperture voltage is shown as below:

1. Click the **Service** icon in the menu page to access the **Service** interface.
2. Click **Other Self-test** in the **Self-test** selection.

The interface as shown in Figure 12-20 will pop up on the screen.

Figure 12-20 Other Self-test

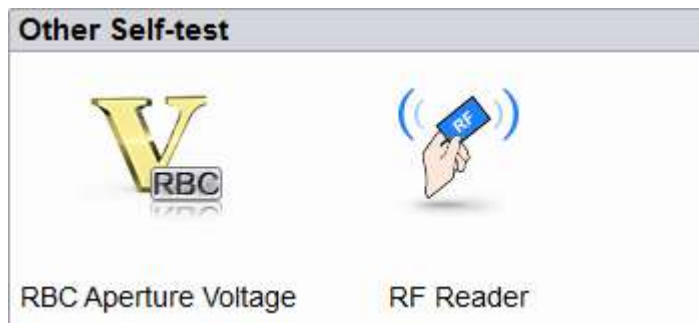

3. Click **RBC Aperture Voltage** to start self-test.

The system will perform the corresponding self-test operations. After the self-inspection is completed, a dialog box will pop up to show the self-inspection results.

Figure 12-21 RBC Aperture Voltage Self-test Results

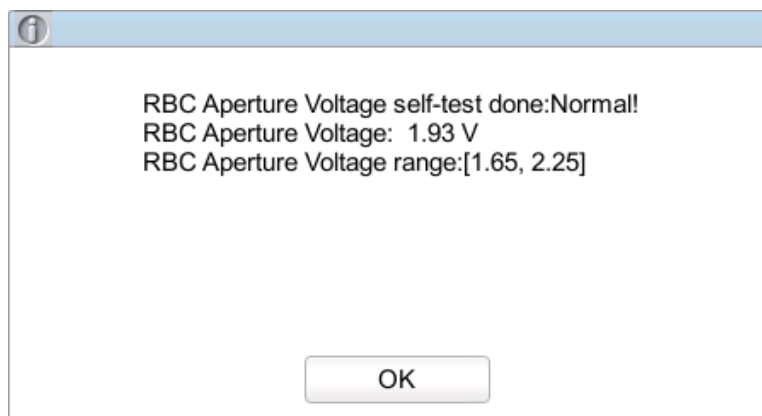

RF Card Reader (for a closed system with a built-in card reader)

If the analyser is a closed system with a built-in card reader, you can carry out a self-test on its built-in RF card reader. The operation procedures are as shown below.

1. Click the **Service** icon in the menu page to access the **Service** interface.
2. Click **Other Self-test** in the **Self-test** selection.
3. Click the icon of **RF Reader** to start self-test.

A dialog box will pop up as shown below.



4. According to the interface prompt, put the RF card on the card reader in front of the analyser. The system will perform the corresponding self-test operations. After the self-inspection is completed, a dialog box will pop up to show the self-inspection results.

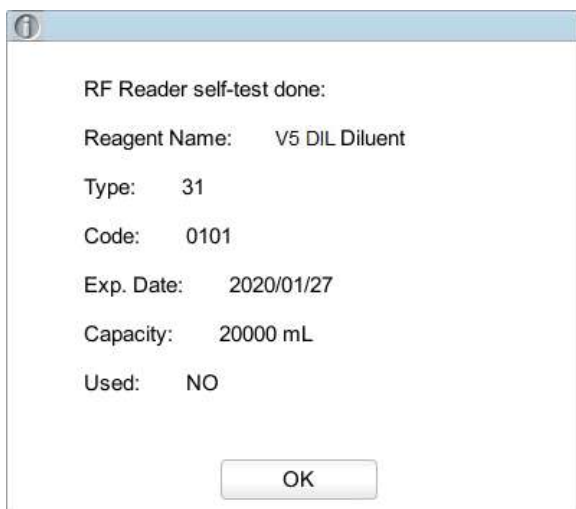

5. Click **OK** to close the message box.

12.4 System Status

You can view the current status information of the analyser in the **Status** selection, including temperature, voltage and current, and version information.

12.4.1 Temperature

1. Click the **Service** icon in the menu page to access the **Service** interface.
2. Click **Temperature** in the **Status** selection.

The interface as shown in Figure 12-22 will pop up on the screen.

Figure 12-22 View Temperature Status

Temperature	
Preheating bath temperature	50.1 [48.5, 51.5]
Ambient Temperature	29.9 [15.0, 30.0]
Optical System Temperature	34.9 [30.0, 40.0]

User can view the current temperature information of the analyser, including the temperature of preheating bath temperature, ambient temperature and the temperature of the optical system. If the results of the temperature testing exceed the normal range, they will be highlighted by the red background.

12.4.2 Voltage and Current

1. Click the **Service** icon in the menu page to access the **Service** interface.
2. Click **Voltage/Current** in the **Status** selection.

The interface as shown below will pop up on the screen.

Figure 12-23 Voltage and Current

Voltage/Current	
Voltage (V)	
P12V	P24V
12 [10.0, 15.0]	24 [20.0, 28.0]
A+12V	A-12V
12 [10.0, 15.0]	-12 [-15.0, -10.0]
Constant Current Source Voltage	HGB Blank Voltage:
56 [50.0, 75.0]	4.5 [4.2, 4.8]
Current (mA)	
Laser Diode Current	
24	

You can view the voltage and current information of the analyser. The voltage or current value that exceeds the normal range will be displayed in a red background.

12.4.3 Disk Information

You can view the disk information of the analyser, including disk name, capacity and used space. Specific steps are shown below.

1. Click the **Service** icon in the menu page to access the **Service** interface.
2. Click **Disk Info** in the **Status** selection.

The disk information interface displays. See Figure 12-24.

Figure 12-24 Disk Information

Item	Capacity	Used space
Flash	501.5M	0%
SD card	7.3G	6%

12.5 Data Cleanup

You can clean up the data stored in the analyser. Specific steps are shown below.

1. Click the **Service** icon in the menu page to access the **Service** interface.
2. Click **Data Cleanup** in the **Other** selection.

The data cleanup interface displays. See Figure 12-25.

Figure 12-25 Data Cleanup

Data Cleanup

Time range

Start Time: System installed date

End time: 2018/09/29

Data

Counting result Scattergram

L-J QC results



Log files

Core files

Apply OK Cancel

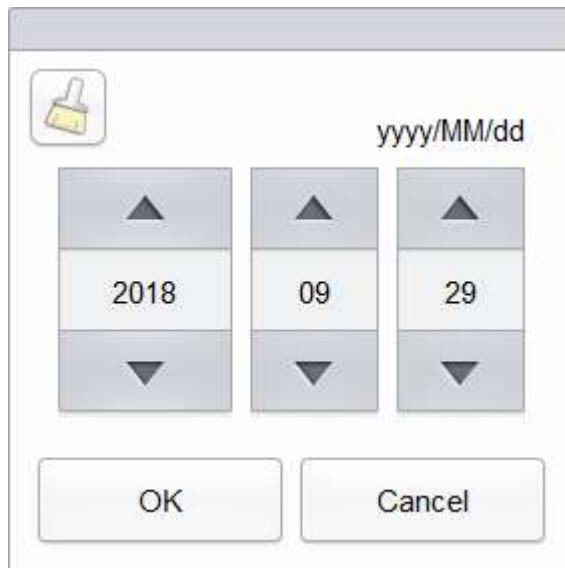
3. Click the **End time** combo box, set the date range of the data to be cleaned up in the popup dialog box.



- The input sequence of the controls is the same with the date format on the top right corner of the dialog box. For example, if the data format is **yyyy/MM/dd**, you should input the data in the sequence of year, month, and date.
- Click  or  to select a date and time or enter the information in the textbox directly.
- Click  to clear the data and input again.

For example, If the **End time** is set to **2016/03/31**, the data generated from system installation date to 31 March 2016 will be cleared.

4. Click **OK** to save the settings and close the dialog box.
5. Select the data to be cleaned up.

You can clean up the following data:

- Counting results
 - L-J QC results
 - Log files
 - Core Files
 - Scattergram
6. Click **Apply** or **OK**.

The interface pops up a dialog box as shown below, indicating the cleanup is completed.

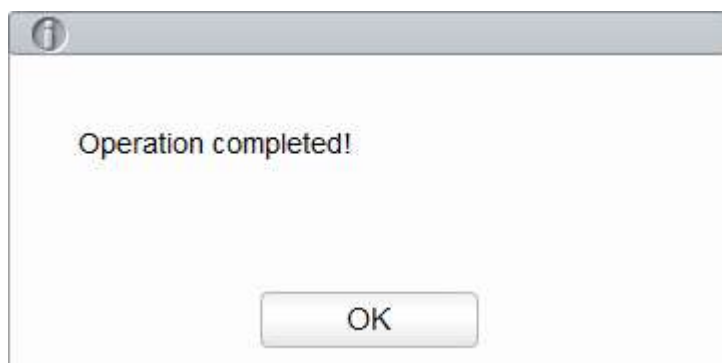

12.6 Version Information

You can view the current version information of all parts of the analyser, and export the version information to a USB flash disk. Detailed steps are shown below:

1. Click the **Service** icon in the menu page to access the **Service** interface.
2. Click **Version Info.** in the **Other** selection.

Version information interface will pop up on the screen. See Figure 12-26.

Figure 12-26 Version Information

The screenshot shows a window titled "Version" with two columns of text input fields. Each field is labeled with a component name and contains a version number. An "Export" button is located at the bottom right of the window.

Component	Version
Software Full Version	0.5.20.20304
Software Release Version	5
Technical File Version	B2.0
Machine Type	TD1108
Application Software	0.2.0.305
Algorithm	0.1.1.9078
Boot Software	0.11.9.17309
MLO	0.11.9.17309
MCU	1.3.0.15706
FPGA	0.1.0.1290
Fluidics Sequence	3.1108B.001.005
Operating System	3.2.0.20008
LIBS	0.1.0.15839
HPCBA	0.0.0.0
RF Reader MCU	1.1.0.2865

Export

3. Insert a **USB** flash disk in the **USB** interface on the analyser.
4. Click **Export**, and select the export path in the dialog box, and then enter the file name.
The file will be exported to the root directory of the USB flash disk (**/udisk/sda1**) by default as shown below.

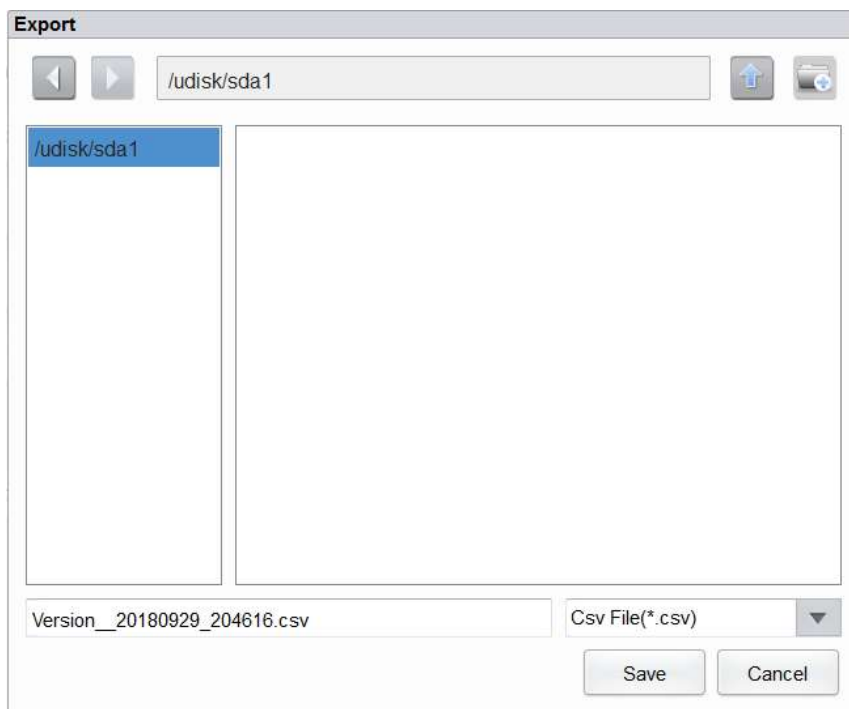

5. Click **Save** to start exporting.

After Export is completed, the message box as shown below will pop up.



6. Click **OK** to exit.

12.7 Screen Test

You can run a screen test to detect dead pixels or stuck pixels on the screen. Detailed steps are shown below:

1. Click the **Service** icon in the menu page to access the Service interface.
2. Click **Screen Test** in the **Other selection** to enter the screen test interface. As shown in Figure 12-27.

Figure 12-27 Screen Test

3. Find out if there are any dead pixels on the screen, touch the screen to change the colour and continue to check.

When the interface disappears and returns to the Service interface, the screen test is complete. If there are dead pixels on the screen, contact our customer service department for maintenance and handling.

12.8 Touch Screen Calibration

When the touch screen has offset, it needs to be recalibrated. Detailed steps are shown below:

1. Click the **Service** icon in the menu page to access the **Service** interface.
2. Click **Touch Screen Cal.** in the **Cal** selection.
3. Click the calibration point “+” on the screen in order.

When the calibration point disappears and the system return to the service screen, it indicates the completion of the calibration.

12.9 Log

In the Log interface, you can view the records of **Set Paras**, **Other Logs**, **Fault Logs** and **All Logs**.

NOTE

- If a new record is added when the log is full, the newest record will overwrite the oldest one automatically.
 - The administrator can view both his/her own operation logs and the general users' operation logs, while the general users can only review their own operation logs.
 - The log can keep records of up to 5 years.
-

12.9.1 All Logs

1. Click the **Service** icon in the menu page to access the **Service** interface.
2. Click **All Logs** in the **Log** selection.

You can view all logs (visible to the users of the current access level).

Figure 12-28 All Logs

All Logs				
2018/09/29		2018/09/29		
No.	Time	Summary Information	Details	Operator
1	2018/09/29 20:18:45	Shutdown After Draining	Shutdown After Draining	Administrator a...
2	2018/09/29 20:18:19	Report Error	0xb2004001 : Background abnor...	Administrator a...
3	2018/09/29 20:18:19	Run	Background mode counting run ...	Administrator a...
4	2018/09/29 20:18:16	Run	Background mode counting run ...	Administrator a...
5	2018/09/29 20:18:10	Startup	Startup	Administrator a...
6	2018/09/29 20:18:07	Login	admin(admin) Login	Administrator a...
7	2018/09/29 20:15:34	Shutdown After Draining	Shutdown After Draining	Administrator a...
8	2018/09/29 20:13:51	Troubleshooting	Troubleshooting finished. Failed ...	Administrator a...
9	2018/09/29 20:13:50	Troubleshooting	Enable Troubleshooting	Administrator a...
10	2018/09/29 20:13:48	Troubleshooting	Troubleshooting finished. Failed ...	Administrator a...

Date and Time:2018/09/29 20:18:45
 Operator:Administrator admin (admin)
 Summary Information:Shutdown After Draining
 Details:Shutdown After Draining

3. Select the dates in the two date textboxes, and then you can view the all logs within the date range, including operation time, log information and the operator.

12.9.2 Parameter Revision Logs

1. Click the **Service** icon in the menu page to access the **Service** interface.
2. Click **Set Paras** in the **Log** selection.

You can view the parameter revision logs (which can be viewed by the user with the current level of access) within a specified date range.

Figure 12-30 Fault Logs

Fault Logs				
2018/09/29		2018/09/29		
No.	Time	Summary Information	Details	Operator
1	2018/09/29 20:18:19	Report Error	0xb2004001 : Background abnor...	Administrator a...
2	2018/09/29 20:13:51	Troubleshooting	Troubleshooting finished. Failed ...	Administrator a...
3	2018/09/29 20:13:50	Troubleshooting	Enable Troubleshooting	Administrator a...
4	2018/09/29 20:13:48	Troubleshooting	Troubleshooting finished. Failed ...	Administrator a...
5	2018/09/29 20:13:47	Troubleshooting	Enable Troubleshooting	Administrator a...
6	2018/09/29 20:13:19	Troubleshooting	Troubleshooting finished. Failed ...	Administrator a...
7	2018/09/29 20:13:18	Troubleshooting	Enable Troubleshooting	Administrator a...
8	2018/09/29 20:13:16	Troubleshooting	Troubleshooting finished. Failed ...	Administrator a...
9	2018/09/29 20:13:15	Troubleshooting	Enable Troubleshooting	Administrator a...
10	2018/09/29 20:13:14	Troubleshooting	Troubleshooting finished. Failed ...	Administrator a...

Date and Time:2018/09/29 20:18:19
 Operator:Administrator admin (admin)
 Summary Information:Report Error
 Details:0xb2004001 : Background abnormal.

3. Select the dates in the two date textboxes, and then you can view the fault logs within the date range, including date and time when the faults occur, fault description and the operator.

12.9.4 Other Logs

1. Click the **Service** icon in the menu page to access the **Service** interface.
2. Click **Other Logs** in the **Log** selection.

You can view other logs besides parameter revision logs and fault logs.

Figure 12-31 Other Logs

Other Logs				
2018/09/29		2018/09/29		
No.	Time	Summary Information	Details	Operator
1	2018/09/29 20:18:45	Shutdown After Draining	Shutdown After Draining	Administrator a...
2	2018/09/29 20:18:19	Run	Background mode counting run ...	Administrator a...
3	2018/09/29 20:18:16	Run	Background mode counting run ...	Administrator a...
4	2018/09/29 20:18:10	Startup	Startup	Administrator a...
5	2018/09/29 20:18:07	Login	admin(admin) Login	Administrator a...
6	2018/09/29 20:15:34	Shutdown After Draining	Shutdown After Draining	Administrator a...
7	2018/09/29 20:13:37	Login	admin(admin) Login	Administrator a...
8	2018/09/29 20:13:31	Logout	admin(admin) Logout	Administrator a...
9	2018/09/29 19:59:50	Replace Reagent	Reagent Name:REAGENT_DT U...	Administrator a...
10	2018/09/29 19:31:24	QC file added	L-J QC, 2File added	Administrator a...

Date and Time:2018/09/29 20:18:45
 Operator:Administrator admin (admin)
 Summary Information:Shutdown After Draining
 Details:Shutdown After Draining

3. Select the dates in the two date textboxes to view the logs within the date range, including operation date and time, operation records and the operator.

12.10 Downloading Service Logs

In the use of the analyser, when errors occur and can not be removed, it's recommended that you export the service logs file to a USB flash disk and send the file to Woodley Equipment Company customer service engineer. Specific steps are shown below.

1. Insert a USB flash disk into the USB interface on the analyser.
2. Click the **Service** icon in the menu page to access the **Service** interface.
3. Click **Service Log** in the **Debug** selection.
4. Select the data range of the logs to be exported in the pop-up dialog box. See Figure 12-32.

Figure 12-32 Downloading Service Logs



5. Click **Export**.

The **host_download.tar** file is exported to the root directory of the USB flash disk, and a message box is shown below.

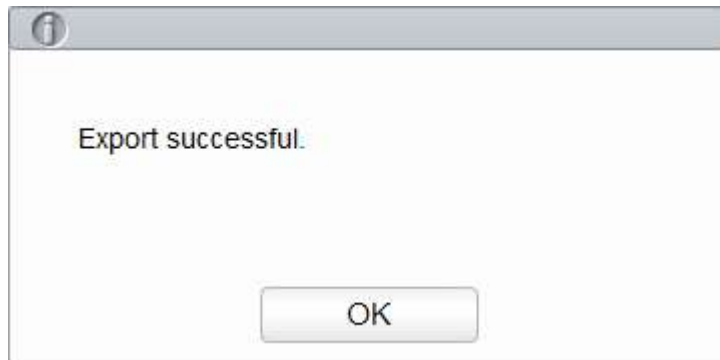

6. Send the **host_download.tar** file to our customer service engineer.

13 Troubleshooting

13.1 Introduction

This chapter contains information that is helpful in locating and resolving problems that may occur during the operation of your analyser.

NOTE

This chapter is not a complete service manual and is limited to problems that are readily diagnosed and/or corrected by the user of the analyser. If the recommended solution fails to solve the problem, contact Woodley Equipment Company customer service department or your local agent.

13.2 Dealing with Error Messages

In the use of the analyser, when the software detects abnormalities, an error message will be displayed on the upper right of the screen as shown in Figure 13-1 and the main unit will sound an alarm.

Figure 13-1 Error Messages

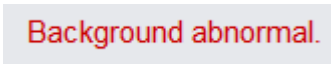

Background abnormal.

You can refer to the following steps to deal with the error messages.

1. Click the error message area.

As shown in Figure 13-2, the popup dialog box displays the error description and its help information. The error descriptions are displayed in the order of error occurrence.

Figure 13-2 Error Message Dialog Box

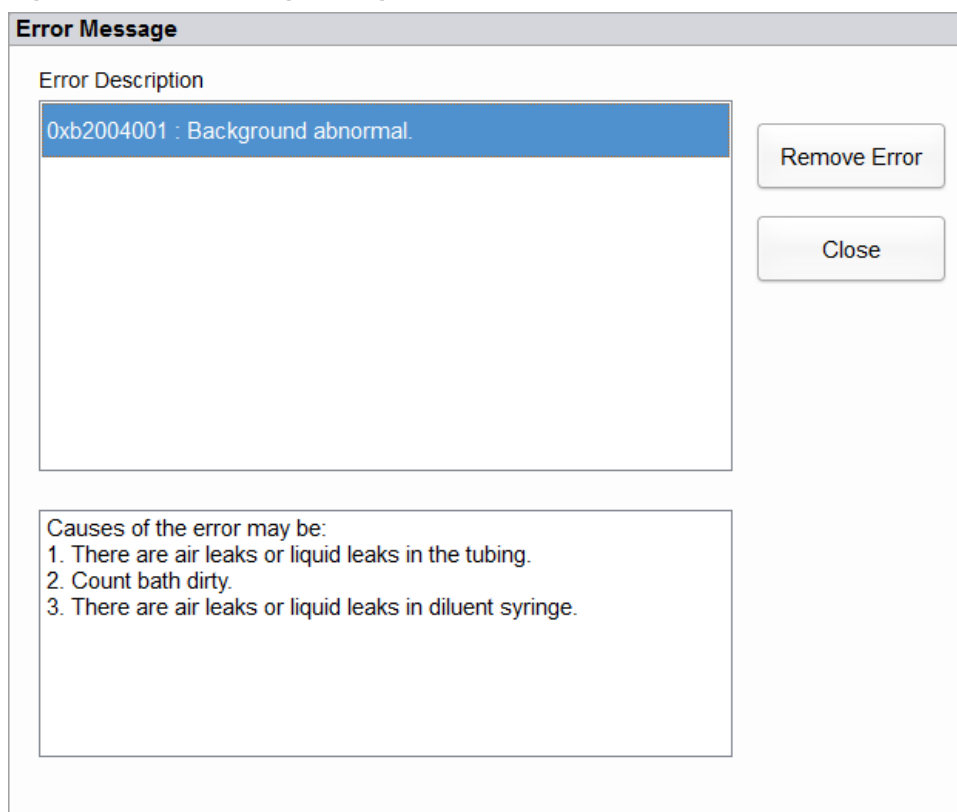

2. Touch the screen to disable the beep.
3. Click **Remove Error**.

Normally, the system will automatically remove the errors.

For errors which cannot be removed automatically, you can take appropriate actions by following the error help information or **13.3 Error Message Reference**.

13.3 Error Message Reference

Possible errors and the corresponding help information are shown in Table 13-1.

Table 13-1 Error Message Reference

Problem Name	Troubleshooting Information
-12V power is not working properly.	<ol style="list-style-type: none"> 1. Please power off the analyser directly and restart later. 2. If the error still exists, contact our customer service department.
Optical assembly cover is open.	<ol style="list-style-type: none"> 1. Close the optical assembly cover. 2. Click the Remove Error button to remove this error. 3. If the error still exists, contact our customer service department.
The CC source voltage is abnormal.	<ol style="list-style-type: none"> 1. Please power off the analyser directly and restart later. 2. If the error still exists, contact our customer service department.

Problem Name	Troubleshooting Information
Abnormal laser current.	<ol style="list-style-type: none"> 1. Please power off the analyser directly and restart later. 2. If the error still exists, contact our customer service department.
Startup failure.	<ol style="list-style-type: none"> 1. Click the Remove Error button to remove this error. 2. If the error still exists, contact our customer service department.
Startup initialisation is not executed.	<ol style="list-style-type: none"> 1. Click the Remove Error button to remove this error. 2. If the error still exists, contact our customer service department.
The right-side door is open.	<ol style="list-style-type: none"> 1. Close the right side door. 2. Click the Remove Error button to remove this error. 3. If the error still exists, contact our customer service department.
+12V power is not working properly.	<ol style="list-style-type: none"> 1. Please power off the analyser directly and restart later. 2. If the error still exists, contact our customer service department.
V5 DIL Diluent expired.	<ol style="list-style-type: none"> 1. Check if the V5 DIL diluent has expired. If so, replace it with a new container of V5 DIL. 2. Click the Remove Error button, the Reagent Management screen will be displayed. 3. Set the reagent information by referring to 11 Reagent Management. 4. If the error still exists, contact our customer service department.
V5 LY1 Lyse expired.	<ol style="list-style-type: none"> 1. Check if the V5 LY1 Lyse has expired. If so, replace it with a new container of V5 LY1. 2. Click the Remove Error button, the Reagent Management screen will be displayed. 3. Set the reagent information by referring to 11 Reagent Management. 4. If the error still exists, contact our customer service department.
V5 LY2 Lyse expired.	<ol style="list-style-type: none"> 1. Check if the V5 LY2 Lyse has expired. If so, replace it with a new container of V5 LY2. 2. Click the Remove Error button, the Reagent Management screen will be displayed. 3. Set the reagent information by referring to 11 Reagent Management. 4. If the error still exists, contact our customer service department.
Preheating bath temperature out of working range.	<ol style="list-style-type: none"> 1. Click the Remove Error button to remove this error. 2. If the error still exists, contact our customer service department.
Abnormal HGB background voltage.	<ol style="list-style-type: none"> 1. Adjust the HGB background voltage within the specified range (4.2V~4.8V), preferably 4.5V. Refer to 5.5.1 Gain Settings. 2. If the error still exists, contact our customer service department.
Abnormal RBC aperture voltage.	<ol style="list-style-type: none"> 1. Click the Remove Error button to remove this error. 2. If the error still exists, contact our customer service department.

Problem Name	Troubleshooting Information
Abnormal background.	<ol style="list-style-type: none"> 1. Check whether the diluent is contaminated. 2. If not, click the Remove Error button to remove the error. 3. If the error still exists, contact our customer service department.
Failed to read sampling syringe parameter.	<ol style="list-style-type: none"> 1. Click the Remove Error button to remove this error. 2. If the error still exists, contact our customer service department.
Failed to configure sampling syringe parameter.	<ol style="list-style-type: none"> 1. Click the Remove Error button to remove this error. 2. If the error still exists, contact our customer service department.
Sampling syringe action overtime.	<ol style="list-style-type: none"> 1. Click the Remove Error button to remove this error. 2. If the error still exists, contact our customer service department.
Sampling syringe busy.	<ol style="list-style-type: none"> 1. Click the Remove Error button to remove this error. 2. If the error still exists, contact our customer service department.
Failed to read LYSE syringe parameter.	<ol style="list-style-type: none"> 1. Click the Remove Error button to remove this error. 2. If the error still exists, contact our customer service department.
Failed to configure LYSE syringe parameter.	<ol style="list-style-type: none"> 1. Click the Remove Error button to remove this error. 2. If the error still exists, contact our customer service department.
LYSE syringe action overtime.	<ol style="list-style-type: none"> 1. Click the Remove Error button to remove this error. 2. If the error still exists, contact our customer service department.
LYSE syringe busy.	<ol style="list-style-type: none"> 1. Click the Remove Error button to remove this error. 2. If the error still exists, contact our customer service department.
Vertical motor instruction parameter error.	<ol style="list-style-type: none"> 1. Click the Remove Error button to remove this error. 2. If the error still exists, contact our customer service department.
Failed to read vertical motor parameter.	<ol style="list-style-type: none"> 1. Click the Remove Error button to remove this error. 2. If the error still exists, contact our customer service department.
Vertical motor timeout.	<ol style="list-style-type: none"> 1. Click the Remove Error button to remove this error. 2. If the error still exists, contact our customer service department.
Failed to read the remaining steps of vertical motor.	<ol style="list-style-type: none"> 1. Click the Remove Error button to remove this error. 2. If the error still exists, contact our customer service department.
The vertical motor is busy.	<ol style="list-style-type: none"> 1. Click the Remove Error button to remove this error. 2. If the error still exists, contact our customer service department.
Failed to read preheating bath temperature.	<ol style="list-style-type: none"> 1. Make sure the temperature sensor is correctly installed. 2. If the error still exists, contact our customer service department.
Failed to read optical system temperature.	<ol style="list-style-type: none"> 1. Make sure the temperature sensor is correctly installed. 2. If the error still exists, contact our customer service department.

Problem Name	Troubleshooting Information
Failed to read ambient temperature.	<ol style="list-style-type: none"> 1. Make sure the temperature sensor is correctly installed. 2. If the error still exists, contact our customer service department.
Waste is full.	<ol style="list-style-type: none"> 1. Empty the waste container or install a new waste container. 2. Click the Remove Error button to remove this error. 3. If the error still exists, contact our customer service department.
The setting temperature of optical system out of range.	<ol style="list-style-type: none"> 1. Click the Remove Error button to remove this error. 2. If the error still exists, contact our customer service department.
Optical system temperature out of working range.	<ol style="list-style-type: none"> 1. Click the Remove Error button to remove this error. 2. If the error still exists, contact our customer service department.
Flow cell clog.	<ol style="list-style-type: none"> 1. Click the Remove Error button to remove this error. 2. If the error still exists, contact our customer service department.
Failed to read horizontal motor parameter.	<ol style="list-style-type: none"> 1. Click the Remove Error button to remove this error. 2. If the error still exists, contact our customer service department.
Failed to configure Horizontal motor parameter.	<ol style="list-style-type: none"> 1. Click the Remove Error button to remove this error. 2. If the error still exists, contact our customer service department.
Horizontal motor timeout.	<ol style="list-style-type: none"> 1. Click the Remove Error button to remove this error. 2. If the error still exists, contact our customer service department.
The optocoupler of the horizontal motor is not working properly.	<ol style="list-style-type: none"> 1. Click the Remove Error button to remove this error. 2. If the error still exists, contact our customer service department.
The horizontal motor is busy.	<ol style="list-style-type: none"> 1. Click the Remove Error button to remove this error. 2. If the error still exists, contact our customer service department.
V5 DIL Diluent running out.	<ol style="list-style-type: none"> 1. Check whether the V5 DIL container is empty. If so, install a new container of V5 DIL. 2. Click the Remove Error button to remove the error. 3. If the error still exists, contact our customer service department.
V5 LY1 Lyse running out or air bubbles in inlet tubing.	<ol style="list-style-type: none"> 1. Check whether the V5 LY1 is running out or there are air bubbles in the inlet tubing of V5 LY1. If it is running out, install a new container of V5 LY1; If there is still plenty of V5 LY1 or there are bubbles, perform step 2. 2. Click the Remove Error button to remove the error. 3. If the error still exists, contact our customer service department.

Problem Name	Troubleshooting Information
V5 LY2 Lyse running out or air bubbles in inlet tubing.	<ol style="list-style-type: none"> 1. Check whether the V5 LY2 is running out or there are air bubbles in the inlet tubing of V5 LY2. If it is running out, install a new container of V5 LY2; If there is still plenty of V5 LY2 or there are bubbles, perform step 2. 2. Click the Remove Error button to remove the error. 3. If the error still exists, contact our customer service department.
V5 DIL Diluent not replaced.	<ol style="list-style-type: none"> 1. Click the Remove Error button to remove this error. 2. If the error still exists, contact our customer service department.
V5 LY1 Lyse not replaced.	<ol style="list-style-type: none"> 1. Click the Remove Error button to remove this error. 2. If the error still exists, contact our customer service department.
V5 LY2 Lyse not replaced.	<ol style="list-style-type: none"> 1. Click the Remove Error button to remove this error. 2. If the error still exists, contact our customer service department.
DIFF probe clogging	<ol style="list-style-type: none"> 1. Click the Remove Error button to remove this error. 2. If the error still exists, contact our customer service department.
Abnormal 12V driving power supply.	<ol style="list-style-type: none"> 1. Please power off the analyser directly and restart later. 2. If the error still exists, contact our customer service department.
Abnormal 24V driving power supply.	<ol style="list-style-type: none"> 1. Please power off the analyser directly and restart later. 2. If the error still exists, contact our customer service department.
Insufficient V5 DIL Diluent.	<ol style="list-style-type: none"> 1. Check whether the V5 DIL container is empty. If so, install a new container of V5 DIL. 2. Click the Remove Error button, the Reagent Management screen will be displayed. 3. Set the reagent information by referring to 11 Reagent Management. 4. If the error still exists, contact our customer service department.
Insufficient V5 LY1 Lyse.	<ol style="list-style-type: none"> 1. Check whether the V5 LY1 container is empty. If so, install a new container of V5 LY1. 2. Click the Remove Error button, the Reagent Management screen will be displayed. 3. Set the reagent information by referring to 11 Reagent Management. 4. If the error still exists, contact our customer service department.
Insufficient V5 LY2 Lyse.	<ol style="list-style-type: none"> 1. Check whether the V5 LY2 container is empty. If so, install a new container of V5 LY2. 2. Click the Remove Error button, the Reagent Management screen will be displayed. 3. Set the reagent information by referring to 11 Reagent Management. 4. If the error still exists, contact our customer service department.

Appendix A Specifications

A.1 Classification

According to the CE classification, the InSight V5 Haematology Analyser belongs to in vitro diagnostic medical devices, rather than those covered by Annex II and devices for performance evaluation.

A.2 Reagents

Reagent Type	Reagent Name
Diluent	V5 DIL Diluent
Lyse	V5 LY2 Lyse
	V5 LY1 Lyse
Medical cleanser	Cleanser

A.3 Parameters

Parameter	Abbreviation	Default Unit
White Blood Cell count	WBC	10 ⁹ /L
Number of Neutrophils	Neu#	10 ⁹ /L
Number of lymphocytes	Lym#	10 ⁹ /L
Number of Monocytes	Mon#	10 ⁹ /L
Number of Eosinophils	Eos#	10 ⁹ /L
Number of Basophils	Bas#	10 ⁹ /L
Percentage of Neutrophils	Neu%	%
Percentage of Lymphocytes	Lym%	%
Percentage of Monocytes	Mon%	%
Percentage of Eosinophils	Eos%	%
Percentage of Basophils	Bas%	%
Red Blood Cell count	RBC	10 ¹² /L

Parameter	Abbreviation	Default Unit
Haemoglobin Concentration	HGB	g/L
Haematocrit	HCT	%
Mean Corpuscular Volume	MCV	fL
Mean Corpuscular Haemoglobin	MCH	pg
Mean Corpuscular Haemoglobin Concentration	MCHC	g/L
Red Blood Cell Distribution Width - Standard Deviation (RDW-SD)	RDW-SD	fL
Red Blood Cell Distribution Width - Coefficient of Variation (RDW-CV)	RDW-CV	%
Platelet count	PLT	10 ⁹ /L
Mean Platelet Volume	MPV	fL
Platelet Distribution Width	PDW	fL
Plateletcrit	PCT	%
White Blood Cell Histogram	WBC Histogram	None
Red Blood Cell Histogram	RBC Histogram	None
Platelet Histogram	PLT Histogram	None
Basophils Scattergram	BASO Scattergram	None
DIFF Scattergram	DIFF Scattergram	None

A.4 Performance Specifications

A.4.1 Display Range

Parameter	Linearity Range	Display Range
WBC	(0~300)×10 ⁹ /L	(0~999)×10 ⁹ /L
RBC	(0.00~8.50)×10 ¹² /L	(0~18.00)×10 ¹² /L
HGB	(0~250)g/L	(0~300)g/L
PLT	(0~3000)×10 ⁹ /L	(0~5000)×10 ⁹ /L
HCT	0%~67%	0%~80%

A.4.2 Normal Background

Parameter	Normal Background
WBC	$\leq 0.2 \times 10^9/L$
RBC	$\leq 0.02 \times 10^{12}/L$
HGB	$\leq 1g/L$
PLT	$\leq 10 \times 10^9/L$
HCT	$\leq 0.5\%$

A.4.3 Linearity Range

Parameter	Linearity range	Deviation range (Whole blood mode)
WBC	$(0.00 \sim 100.00) \times 10^9/L$	$\pm 0.30 \times 10^9/L$ or $\pm 5\%$
	$(100.01 \sim 300.00) \times 10^9/L$	$\pm 10\%$
RBC	$(0.00 \sim 14.50) \times 10^{12}/L$	$\pm 0.05 \times 10^{12}/L$ or $\pm 5\%$
HGB	$(0 \sim 250) g/L$	$\pm 2g/L$ or $\pm 2\%$
PLT	$(0 \sim 1000) \times 10^9/L$ $(1.0 \times 10^{12}/L \leq RBC \leq 10.0 \times 10^{12}/L)$	$\pm 10 \times 10^9/L$ or $\pm 8\%$
	$(1001 \sim 3000) \times 10^9/L$ $(1.0 \times 10^{12}/L \leq RBC \leq 10.0 \times 10^{12}/L)$	$\pm 12\%$
HCT	$0\% \sim 67\%$	$\pm 2\%$ (HCT value) or $\pm 3\%$ (deviation percent)

A.4.4 Repeatability

These repeatability requirements apply only to the situation in which a qualified sample has been run for 10 times and the results of the 1st to 10th runs are used to calculate the repeatabilities.

Species	Parameter	Condition	Whole Blood Repeatability (CV)
Dog	WBC	$(7.3 \sim 16.6) \times 10^9/L$	$\leq 3.0\%$
	Neu%	$39.1\% \sim 84.7\%$	± 4.0 (absolute deviation)
	Lym%	$5.9\% \sim 50.1\%$	± 4.0 (absolute deviation)
	Mon%	$5.2\% \sim 13.0\%$	± 3.0 (absolute deviation)
	Eos%	$0.7\% \sim 18.0\%$	± 3.0 (absolute deviation)
	Bas%	$0.05\% \sim 0.14\%$	± 1.0 (absolute deviation)
	RBC	$(4.5 \sim 10.0) \times 10^{12}/L$	$\leq 2.0\%$
	HGB	$(90 \sim 180)g/L$	$\leq 2.0\%$
	MCV	$(49 \sim 69)fL$	$\leq 1.0\%$

Species	Parameter	Condition	Whole Blood Repeatability (CV)
	PLT	(156~576) ×10 ⁹ /L	≤6.0%
	MPV	(4~12)fL	≤4.0%
Cat	WBC	(8.2~20.4) ×10 ⁹ /L	≤3.0%
	Neu%	25.4%~65.0%	±4.0 (absolute deviation)
	Lym%	25.6%~64.3%	±4.0 (absolute deviation)
	Mon%	0.8%~3.6%	±3.0 (absolute deviation)
	Eos%	3.1%~9.1%	±3.0 (absolute deviation)
	Bas%	0.06%~0.18%	±1.0 (absolute deviation)
	RBC	(6.0~17.0) ×10 ¹² /L	≤2.0%
	HGB	(108~180)g/L	≤2.0%
	MCV	(32~44)fL	≤1.0%
	PLT	(150~350) ×10 ⁹ /L	≤6.0%
	MPV	(4~12)fL	≤4.0%
Rabbit	WBC	(5.0~26.9) ×10 ⁹ /L	≤3.0%
	RBC	(4.0~6.5) ×10 ¹² /L	≤2.0%
	HGB	(85~180)g/L	≤2.0%
	MCV	(59~75)fL	≤1.0%
	PLT	(246~1046) ×10 ⁹ /L	≤6.0%
	MPV	(4~12)fL	≤4.0%
Cow	WBC	(5.0~15.0) ×10 ⁹ /L	≤3.0%
	Neu%	38.8%~49.8%	±4.0 (absolute deviation)
	Lym%	43.5%~55.7%	±4.0 (absolute deviation)
	Mon%	2.5%~6.3%	±3.0 (absolute deviation)
	Eos%	0.1%~1.1%	±3.0 (absolute deviation)
	Bas%	0.51%~3.99%	±1.0 (absolute deviation)
	RBC	(4.0~11.0) ×10 ¹² /L	≤2.0%
	HGB	(106~180)g/L	≤2.0%
	MCV	(30~48)fL	≤1.0%
	PLT	(150~1200) ×10 ⁹ /L	≤6.0%
	MPV	(4~12)fL	≤4.0%
Horse	WBC	(5.5~16.5) ×10 ⁹ /L	≤3.0%
	Neu%	31.4%~59.3%	±4.0 (absolute deviation)
	Lym%	29.3%~61.6%	±4.0 (absolute deviation)

Species	Parameter	Condition	Whole Blood Repeatability (CV)
	Mon%	2.1%~15.8%	±3.0 (absolute deviation)
	Eos%	1.2%~5.6%	±3.0 (absolute deviation)
	Bas%	0.12%~0.91%	±1.0 (absolute deviation)
	RBC	(4.5~7.6) ×10 ¹² /L	≤2.0%
	HGB	(86~180)g/L	≤2.0%
	MCV	(28~70)fL	≤1.0%
	PLT	(253~753) ×10 ⁹ /L	≤6.0%
	MPV	(4~12)fL	≤4.0%
Sheep	WBC	(3.8~15.0) ×10 ⁹ /L	≤3.0%
	Neu%	40.2%~64.5%	±4.0 (absolute deviation)
	Lym%	25.1%~55.0%	±4.0 (absolute deviation)
	Mon%	2.4%~4.4%	±3.0 (absolute deviation)
	Eos%	1.0%~9.9%	±3.0 (absolute deviation)
	Bas%	0.09%~1.39%	±1.0 (absolute deviation)
	RBC	(6.2~11.2) ×10 ¹² /L	≤2.0%
	HGB	(85~180)g/L	≤2.0%
	MCV	(26~31)fL	≤1.0%
	PLT	(205~505) ×10 ⁹ /L	≤6.0%
	MPV	(4~12)fL	≤4.0%

NOTE

If you need to view the repeatability of other species, please contact our customer service department or the local agent.

A.4.5 Carryover

Parameter	Carryover
WBC	≤0.5%
RBC	≤0.5%
HGB	≤0.5%
PLT	≤1.0%
HCT	≤0.5%

A.5 Sample Interference

If there is sample interference, the analysis results of the sample may be affected. See the table below.

Parameter	Analysis Results	Interference Source
WBC	Low WBC count	Leukoagglutination
	High WBC count	<ul style="list-style-type: none"> ● Possible Platelet agglutination ● Cool insoluble protein ● Cryoglobulins ● Fibrin ● Excessive numbers of giant platelets (platelets$>1000\times 10^9/L$) ● Nucleated red blood cells
RBC	Low RBC count	<ul style="list-style-type: none"> ● Agglutinated RBCs (Cold agglutinins) ● Microcytosis ● Schistocytes
	High RBC count	<ul style="list-style-type: none"> ● Leukocytosis ($>100\times 10^9/L$) ● Excessive numbers of giant platelets (platelets$>1000\times 10^9/L$)
HGB	High HGB count	<ul style="list-style-type: none"> ● Leukocytosis ($>100\times 10^9/L$) ● Lipaemia ● Jaundice ● Paraprotein
HCT	Low HCT value	<ul style="list-style-type: none"> ● Agglutinated RBCs (Cold agglutinins) ● Microcytes ● Schistocytes
	High HCT value	<ul style="list-style-type: none"> ● Leukocytosis ($>100\times 10^9/L$) ● Severe diabetes ● Uremia ● Spherocytes
PLT	Low PLT count	<ul style="list-style-type: none"> ● Possible Platelet agglutination ● pseudothrombocytopenia ● Giant platelets
	High PLT count	<ul style="list-style-type: none"> ● Microcytes ● Schistocytes ● WBC fragments ● Cool insoluble protein ● Cryoglobulins

A.6 Input/output Device



WARNING

- Accessory equipment connected to the analog and digital interfaces must comply with the relevant Safety and EMC standards (e.g., IEC 60950 Safety of Information Technology Equipment Standard and CISPR 22 EMC of Information Technology Equipment Standard (CLASS B). Anyone who connects additional equipment to the signal input or output ports and configures a system is responsible for ensuring that the system works properly and complies with the safety and EMC requirements. If you have any problems, consult the technical services department of your local agent.
 - Be sure to use specified fuse only.
-

- Analyser
 - Touch screen: 10.4 inches embedded touch screen with a resolution of 800x600
 - One LAN interface
 - 4 USB interfaces
 - Thermal printer
- Keyboard (Optional, USB)
- Mouse (Optional, USB)
- External barcode scanner (optional, USB)
- Printer (optional, USB)
- USB flash disk (optional, USB)

A.7 Power

- Voltage: A.C 100V~240V
- Input power: ≤200VA
- Frequency: 50/60 Hz

A.8 Fuse

T6.3AL 250V

A.9 EMC Description

This equipment complies with the emission and immunity requirements of the IEC 61326-1:2012, EN 61326-1:2013, IEC 61326-6-2-6:2012 and EN 61326-2-6:2013. This equipment has been designed and tested to CISPR 11 Class B. In a domestic environment it may cause radio interference, in which case, you may need to take measures to mitigate the interference.

The test items, standards and requirements on electromagnetic compatibility for the environment are shown in the table below.

Test Item	Test Standard	Test Requirement
Conducted Disturbance	EN 61326-1:2013 EN 61326-2-6:2013	1Mode-Class B
Radiated Disturbance	EN 61326-1:2013 EN 61326-2-6:2013	1Mode-Class B
Harmonic Current	EN 61326-1:2013 EN 61326-2-6:2013	Class A
Voltage Fluctuation and Flicker	EN 61326-1:2013 EN 61326-2-6:2013	/
ESD Immunity	EN 61326-1:2013 EN 61326-2-6:2013	air discharge: $\pm 2, \pm 4, \pm 8$ kV contact discharge: $\pm 2, \pm 4$ kV
Radiated Electromagnetic Field Immunity	EN 61326-1:2013 EN 61326-2-6:2013	80MHz-1GHz, 1.4GHz-2GHz 3V/m 80%AM(1kHz); 2GHz-2.7GHz 1V/m 80%AM(1kHz)
EFT Immunity	EN 61326-1:2013 EN 61326-2-6:2013	1kV 5/50 ns Tr/Th 5kHz repetition frequency
Surge Immunity	EN 61326-1:2013 EN 61326-2-6:2013	1.2/50(8/20) μ s Tr/Th 1kV L-N 2kV L-PE, N-PE
Conducted Immunity	EN 61326-1:2013 EN 61326-2-6:2013	0.15MHZ~80MHZ 3V(r.m.s)(unmodulated)
Voltage Dips and Interruptions Immunity	EN 61326-1:2013 EN 61326-2-6:2013	Voltage dips: 0%UT, 1cycle 40%UT, 5cycle 70%UT, 25cycle Voltage interruption: <5%UT, 250cycle

A.10 Environment Conditions

NOTE

Be sure to use and store the analyser in the specified environment.

Environment Conditions	Operating Environment	Storage Environment	Running Environment
Ambient temperature	10°C~30°C (50°F~86°F)	-10°C~40°C (14°F~104°F)	5°C~40°C (41°F~104°F)

Environment Conditions	Operating Environment	Storage Environment	Running Environment
Relative humidity	20%~85%	10%~90%	10%~90%
Atmospheric pressure	70kPa~106kPa	50kPa~106kPa	70kPa~106kPa

A.11 Dimensions and Weight

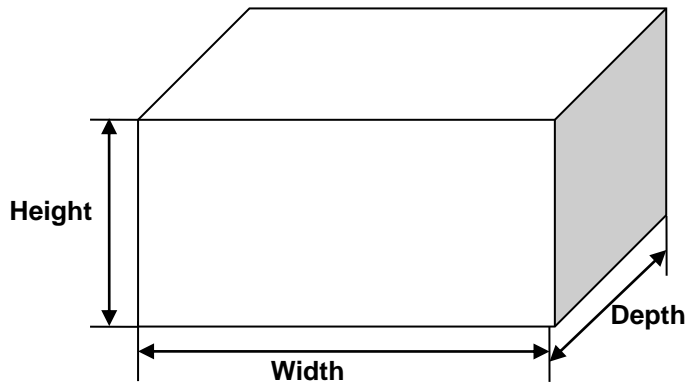

Analyser	Dimensions and Weight
Width (mm)	364
Height(mm)	498
Depth (mm)	431
Weight (kg)	28

A.12 Contraindications

None

Appendix B Terms and Abbreviations

WB	Whole Blood
PD	Predilute

Appendix C Packing List

No.	Parameter	Quantity	Unit
1	Auto haematology analyser.	1	PCS
2	Power Cable	1	PCS
3	Peripheral Grounding Cable	1	PCS
4	Operator's Manual	1	PCS
5	Quick Operation Guide	1	PCS
6	Diluent Adapter Tube	1	PCS
7	Waste Float Adapter Tube	1	PCS
8	Waste container	1	PCS
9	Reagent Operation Guide (for closed systems only)	1	PCS
10	Inspection Record	1	PCS



Woodley Equipment Company Ltd
Old Station Park Buildings
St John Street
Horwich
Bolton
BL6 7NY, UK
Tel: +44 (0) 1204 669033
Fax: +44 (0) 1204 669034
Email: sales@woodleyequipment.com
Web: www.woodleyequipment.com