

# seca 655/654

 **Order here!**

 **PRAXISDIENST**  
Medical Supplies since 1953

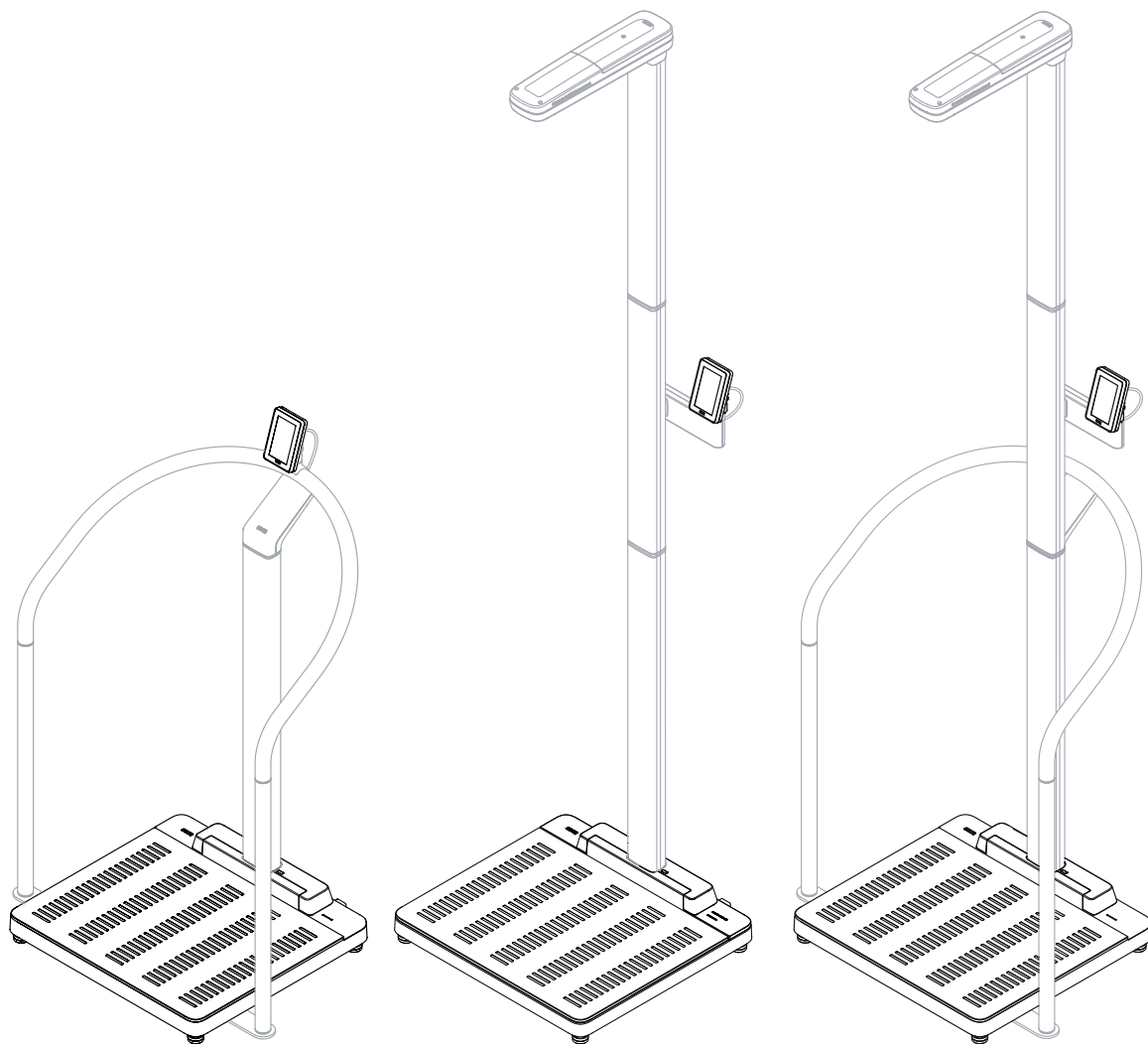

# TABLE OF CONTENTS

<b>1. About this document</b> .....	<b>76</b>	<b>6. Operation</b> .....	<b>97</b>
1.1 Display conventions .....	76	6.1 Activating the multifunctional display .....	97
Display in the text .....	76	6.2 Measuring weight .....	98
Display in graphics .....	76	6.3 Entering the height manually .....	98
1.2 PDF version .....	76	6.4 Measuring weight and height (devices with ultrasonic measuring rod) .....	99
<b>2. Description of device</b> .....	<b>77</b>	6.5 Using extended weighing functions .....	100
2.1 Intended use of the scale .....	77	Taring additional weight (tare) .....	100
2.2 Intended use of compatible seca products. . . . .	77	Permanently displaying the weight (Hold) . . .	101
Standing aid seca 455 .....	77	Devices with measuring rod: Permanently displaying the weight and height (Hold). . . . .	102
Ultrasonic measuring rod seca 257, seca 256 .....	77	Permanently storing additional weight (pre-tare). . . . .	102
2.3 Description of function .....	77	Automatic switchover of weighing range. . .	103
Measuring weight/entering height .....	77	Automatic calculation of BMI or BSA .....	104
Measuring weight and height, ultrasound . . . . .	77	Entering waist circumference .....	104
Network functions .....	77	6.6 Completing the measurement procedure. . . . .	105
Compatibility .....	78	Devices with connection to an EMR System .....	105
2.4 Patient target group .....	78	Devices with connection to the seca analytics 125 software .....	105
2.5 User qualification .....	78	Standalone devices .....	105
Assembly .....	78		
Administration/network operation .....	78		
Measuring mode .....	78		
<b>3. Safety information</b> .....	<b>78</b>		
3.1 Safety precautions in these instructions for use .....	78		
3.2 Basic safety precautions .....	79		
Handling the device .....	79		
Preventing electric shock .....	80		
Preventing injuries and infections .....	80		
Preventing damage to device .....	81		
Handling measuring results .....	81		
Handling packaging material .....	82		
<b>4. Overview</b> .....	<b>83</b>		
4.1 Controls .....	83		
4.2 Controls .....	84		
4.3 Symbols on the multifunctional display (main screen) .....	86		
4.4 Symbols on the multifunctional display (menu) .....	87		
4.5 Markings on the device and on the type plate .....	89		
4.6 Markings on the packaging .....	90		
<b>5. Starting up the device</b> .....	<b>91</b>		
5.1 Scope of delivery .....	91		
5.2 Interfaces .....	92		
5.3 Setting up the device .....	93		
5.4 Connecting a barcode scanner (optional) . . . . .	94		
5.5 Establishing the power supply .....	95		
5.6 Installing the drip guard .....	95		
5.7 Adapting device settings .....	96		
5.8 Transporting the device .....	96		

<b>7. Configuration</b>	<b>106</b>	<b>9. Function check</b>	<b>124</b>
7.1 Basic functions	106	<b>10. Troubleshooting</b>	<b>125</b>
Changing the device mode	106	10.1 General faults	125
Calling up/exiting a menu	107	10.2 Measuring weight	125
Accessing the PDF version of the instructions for use (QR code)	107	10.3 Height measurement, ultrasonic	126
7.2 Measuring	108	10.4 Data transmission	128
Activating the Autohold function	108	10.5 Display message traffic light system	129
Setting filter	108	10.6 Error codes	129
Calibrating ultrasonic height measurement	109	<b>11. Servicing</b>	<b>130</b>
Selecting BMI/BSA/Waist circumf.	111	11.1 Calibrated scales (read off calibration counter and GAL value)	130
7.3 Adjusting display settings	111	11.2 Non-calibrated scales	131
Setting the display language	111	<b>12. Technical data</b>	<b>132</b>
Setting the date format	112	12.1 Menu structures	132
Setting the standby time	112	“Basic” device mode	132
Setting the display brightness	113	“Advanced” device mode	132
Switching over units	114	“Expert”/“Service” device modes	133
7.4 Setting up network functions	115	12.2 Functions/device mode	134
Setting up the device in the seca connect 103 software	115	12.3 General technical data	135
Entering the IP address	116	12.4 Dimensions, weight	136
Activating/deactivating the WiFi function	117	12.5 Weighing technology data, calibrated models	136
Connecting the device to the WiFi network (seca connect 103)	117	12.6 Weighing technology data, non-calibrated models	136
Connecting the device to the WiFi network (WPS)	117	12.7 Technical data, ultrasonic height measurement	137
Automatically clearing measured values (Autoclear)	118	Metrological data	137
7.5 Configuring voice guidance	119	Voice outputs and acoustic signals	137
Selecting a language	119	<b>13. Optional accessories and spare parts</b>	<b>137</b>
Setting the volume	119	<b>14. Compatible seca products</b>	<b>138</b>
Activating/deactivating beeps	120	<b>15. Disposal</b>	<b>138</b>
Activating/deactivating the announcement of patient instructions (Measurement)	121	<b>16. Warranty</b>	<b>139</b>
Activating/deactivating the announcement of measuring results (Results)	121	<b>17. Declaration of conformity</b>	<b>139</b>
7.6 Factory settings	122	17.1 Europe	139
Overview of factory settings	122	17.2 USA and Canada	139
Restoring factory settings	123		
<b>8. Hygiene treatment</b>	<b>123</b>		
8.1 Cleaning	123		
8.2 Disinfecting	124		
8.3 Sterilizing	124		

# 1. ABOUT THIS DOCUMENT

These instructions for use contain information about the operation of the **seca 655/654** scales and compatible seca products.

The installation of compatible seca products is not part of these instructions for use. An overview of compatible seca products is available here:

→ [Compatible seca products, page 138](#)







## 1.1 Display conventions

---

### Display in the text

Symbol	Description
▶	Action
1. 2.	Actions to be performed in the specified sequence
a) b)	Steps of an action that have to be performed in the specified sequence
• •	First level of a list
– –	Second level of a list

### Display in graphics

Symbol	Description
	Indicates points on the device or on device components which require particular attention
	Indicates directions of movement of the device or device components
	Navigation path in menu displays
	Correct action Correct result
	Incorrect action Incorrect result
	Points to the next step of a procedure
	End of a procedure, e.g. the installation of a part

## 1.2 PDF version

---

The device menu contains a QR code which can be used to access the PDF version of these instructions for use and load them e.g. onto your smartphone or tablet PC.

Further information is available here: → [Accessing the PDF version of the instructions for use \(QR code\), page 107](#)

## 2. DESCRIPTION OF DEVICE

### 2.1 Intended use of the scale

The seca scale is mainly used in hospitals, medical practices, outpatient and inpatient health care facilities, and in medically oriented fitness facilities in accordance with national regulations.

The seca scale is used for the conventional determination of weight and establishment of the general state of nutrition; it assists the physician supervising treatment in making a diagnosis or deciding on a course of treatment.

To make an accurate diagnosis, however, the physician must order other specific examinations and take their results into account, in addition to determining a weight value.

### 2.2 Intended use of compatible seca products

#### Standing aid seca 455

The seca standing is mainly used in hospitals, medical practices, outpatient and inpatient health care facilities, and in medically oriented fitness facilities in accordance with national regulations.

In conjunction with compatible seca products, the standing aid supports people who are unable to stand independently.

#### Ultrasonic measuring rod seca 257, seca 256

The seca measuring rod is mainly used in hospitals, medical practices, outpatient and inpatient health care facilities, and in medically oriented fitness facilities in accordance with national regulations.

The seca measuring rod is used in combination with a compatible seca scale for the conventional determination of height (body size), and for early detection of growth disorders; it also assists the physician supervising treatment in making a diagnosis or deciding on a course of treatment.

To make an accurate diagnosis, however, the physician must order other specific examinations and take their results into account, in addition to determining a height value.

### 2.3 Description of function

#### Measuring weight/entering height

Weight calculation is carried out with four weighing cells. The measuring results are shown on the multifunctional display. The height is entered manually.

The Body Mass Index (BMI) or Body Surface Area (BSA) is automatically calculated from the "Weight" and "Height" parameters.

#### Measuring weight and height, ultrasound

With the measuring rod (**seca 257**, **seca 256**), height measurement is carried out using ultrasound. The measuring rod is mounted on a compatible seca scale. The weight and height of the patient are recorded simultaneously. The measuring rod guides the patient through the measurement with configurable voice outputs. The measuring results are transferred to the scale and shown on the multifunctional display. The Body Mass Index (BMI) or Body Surface Area (BSA) is automatically calculated from the "Weight" and "Height" parameters.

#### Network functions

The device can be integrated into a PC network via a LAN interface or via WiFi. The **seca connect 103** is required to set up this integration.

The **seca connect 103** software receives measurement data from the device and forwards them to an EMR System or to the **seca analytics 125** software.

The **seca analytics 125** software receives measurement data from the **seca connect 103** software and processes them graphically. The software therefore assists the physician supervising treatment in evaluating measuring results or making a diagnosis.

#### Compatibility

Configuration software: **seca connect 103**: Version 2.0 or higher, no downward compatibility.

Evaluation software: **seca analytics 125**: Version 1.0 or higher.

## 2.4 Patient target group

---

The device is intended for persons of any age, with the exception of babies. Limitations in terms of weight and height can arise depending on the compatible seca products used:

→ [Technical data, page 132](#)

→ [Compatible seca products, page 138](#)

## 2.5 User qualification

---

#### Assembly

Devices that are shipped partially assembled may only be mounted by sufficiently qualified persons such as specialist dealers, hospital technicians or seca Service technicians.

#### Administration/network operation

The device may only be set up and incorporated in a network by experienced administrators or hospital technicians.

#### Measuring mode

The device may only be operated by persons with formal training in the field of healthcare or medicine.

## 3. SAFETY INFORMATION

### 3.1 Safety precautions in these instructions for use

---



#### DANGER!

Used to identify an extremely hazardous situation. If you fail to take note of this information, serious irreversible or fatal injuries will occur.



#### WARNING!

Used to identify an extremely hazardous situation. If you fail to take note of this information, serious irreversible or fatal injuries may result.



#### CAUTION!

Used to identify a hazardous situation. If you fail to take note of this information, minor to moderate injuries may result.

#### NOTICE!

Used to identify possible incorrect usage of the device. If you fail to take note of this information, you may damage the device, or the measuring results may be incorrect.

#### NOTE

Includes additional information about use of the device.

## 3.2 Basic safety precautions

### Handling the device

- ▶ Please take note of the information in these instructions for use.
- ▶ Keep the instructions for use in a safe place. The instructions for use are a component of the device and must be available at all times.
- ▶ In the interest of patient safety, you and your patients are obliged to report serious events that occur in connection with this product to the manufacturer and the authority responsible in your country.



#### **DANGER!**

##### **Risk of explosion**

Do not use the device in an environment in which one of the following gases has accumulated:

- Oxygen
- Flammable anesthetics
- Other flammable substances/air mixtures



#### **CAUTION!**

##### **Patient hazard, damage to device**

- ▶ Additional devices which are connected to electrical medical devices must provide evidence of compliance with the relevant IEC or ISO standards (e.g. IEC 60950 for data-processing devices). Furthermore, all configurations must comply with the requirements of standards for medical systems (see IEC 60601-1-1 or Section 16 of edition 3.1 of IEC 60601-1 respectively). Anyone connecting additional devices to electrical medical devices is considered a system configurer and is therefore responsible for ensuring that the system complies with the requirements of standards for systems. This also applies to additional devices recommended by seca. Your attention is drawn to the fact that local laws take precedence over the above-mentioned requirements of standards. In the event of any queries, please contact your local specialist dealer or Technical Service.
- ▶ Have servicing carried out regularly as described in the relevant section of this document.
- ▶ Technical modifications may not be made to the device. The device does not contain any parts for servicing by the user. Only have servicing and repairs performed by an authorized seca Service partner. You can find service partners in your area at [www.seca.com](http://www.seca.com) or by sending an e-mail to [service@seca.com](mailto:service@seca.com).
- ▶ Only use original seca accessories and spare parts, otherwise seca will not grant any warranty.



#### **CAUTION!**

##### **Patient hazard, malfunction**

- ▶ Keep other electrical medical devices, e.g. high-frequency surgical devices, a minimum distance of approx. 1 meter away to prevent incorrect measurements or wireless transmission interference.
- ▶ Keep HF devices such as cell phones a minimum distance of approx. 1 meter away to prevent incorrect measurements or wireless transmission interference.
- ▶ The actual transmission output of HF equipment may require minimum distances of more than 1 meter. Details can be found at [www.seca.com](http://www.seca.com).

## Preventing electric shock



### **WARNING!** **Electric shock**

- ▶ Set up the device so that the power supply socket is easy to reach and the device can be disconnected from the power supply quickly.
- ▶ Ensure that your local power supply matches the information on the power supply unit.
- ▶ Do not touch the power supply unit with wet hands.
- ▶ Do not use extension cables or power strips.
- ▶ Make sure that cables are not pinched or damaged by sharp edges.
- ▶ Make sure that cables do not come into contact with hot objects.
- ▶ Do not operate the device at an altitude of more than 3000 m above sea level.
- ▶ Only devices which are approved as medical devices and have no separate power supply may be connected to the USB interface.

## Preventing injuries and infections



### **WARNING!** **Injury from device falling over**

The device is intended as a mobile medical device and is therefore not anchored firmly to a wall or the floor. Device combinations with a standing aid or measuring rod can fall over if used improperly (e.g. as a “climbing frame”).

- ▶ Do not leave children or persons with mental or motor impairments unsupervised.
- ▶ Do not leave pets unsupervised.



### **WARNING!** **Injury from falls**

- ▶ Ensure that the device is positioned firmly and level.
- ▶ Route connecting cables (if present) in such a way that neither user nor patient can trip over them.
- ▶ The device is not intended for supporting patients when getting up e.g. from a wheelchair. Assist people with limited motor skills when they are getting up, e.g. from a wheelchair.
- ▶ Make sure that the patient does not step onto and off the weighing platform right at the edges.
- ▶ Make sure that the patient steps onto and off the weighing platform slowly and safely.



### **WARNING!** **Danger of slipping**

- ▶ Ensure that the weighing platform is dry before the patient steps onto it.
- ▶ Ensure that the patients feet are dry before he or she steps onto the weighing platform.
- ▶ Make sure that the patient steps onto and off the weighing platform slowly and safely.



### **CAUTION!** **Hazard to patient, damage to device**

The area where the patient stands consists of a glass plate. Damage to the glass plate, e.g. as a result of scratches, cracks and chips, presents a risk of injury and can lead to the glass plate breaking.

- ▶ Do not put any sharp-edged objects on the glass plate.
- ▶ Before using the device each time, check the glass plate for scratches, cracks and chips. If you find damage of this kind, have the glass plate replaced with a new one.
- ▶ Do not use the device if the glass plate is damaged.



**WARNING!****Risk of infection**

- ▶ Before and after every measurement, wash your hands to reduce the risk of cross-contamination and nosocomial infections.
- ▶ Hygienically reprocess the device regularly as described in the respective section in this document.
- ▶ Make sure that the patient has no infectious diseases.
- ▶ Make sure that the patient has no open wounds or infectious skin alterations, which may come into contact with the device.

**Preventing damage to device****NOTICE!****Damage to device**

- ▶ Ensure that fluids and dust never get inside the device and the sensors. They can damage the electronics.
- ▶ Disconnect the power supply unit from the mains socket if you intend to not use the device for a longer period of time. Only this way it can be ensured that the device is currentless.
- ▶ Make sure not to drop the device.
- ▶ Do not expose the device to any impacts or vibrations.
- ▶ Perform function controls regularly as described in the relevant section in this document. Do not operate the device if it is damaged or not working properly.
- ▶ Ensure that there is no heat source in the immediate vicinity. Do not expose to direct sunlight. The excessive temperature could damage the electronics.
- ▶ Use the device only under the intended ambient conditions.
- ▶ Store the device only under the intended storage conditions.
- ▶ Observe the information in the technical data concerning cooling times after storage at very high temperatures or warm-up times after storage at very low temperatures.
- ▶ Use alcohol-based disinfectant (e.g. 70 % ethanol) exclusively.
- ▶ Do not use aggressive or abrasive cleaning agents.

**Handling measuring results****NOTICE!****Inconsistent measuring results**

- ▶ Before you electronically save measured values determined using this device and use them further (e.g. in seca PC software or in an EMR system), make sure that the measured values are plausible.
- ▶ If measured values are transmitted to seca PC software or an EMR system, make sure prior to further use that the measured values are plausible and are assigned to the correct patient.

**WARNING!****Incorrect measurement due to reflections**

If there are objects or people in the immediate vicinity of the device, incorrect measurements will result.

- ▶ Ensure that there are no objects or people within 0.5 meter of the front or side of the device during the measuring process.
- ▶ Ensure that the device is at least 0.2 meter away from the wall.
- ▶ Ensure that the patient is not wearing any kind of hair accessory on top of the head.

## Handling packaging material



### **WARNING!**

#### **Risk of suffocation**

Packaging material made of plastic foil (bags) is a choking hazard.

- ▶ Keep packaging material out of reach of children.
- ▶ In the event that the original packing material may not be available anymore, only use plastic bags with security holes in order to reduce the risk of suffocation. Use recyclable materials if possible.

### **NOTE**

Keep the original packing material for future use (e.g. returning for servicing).

## 4. OVERVIEW

### 4.1 Controls

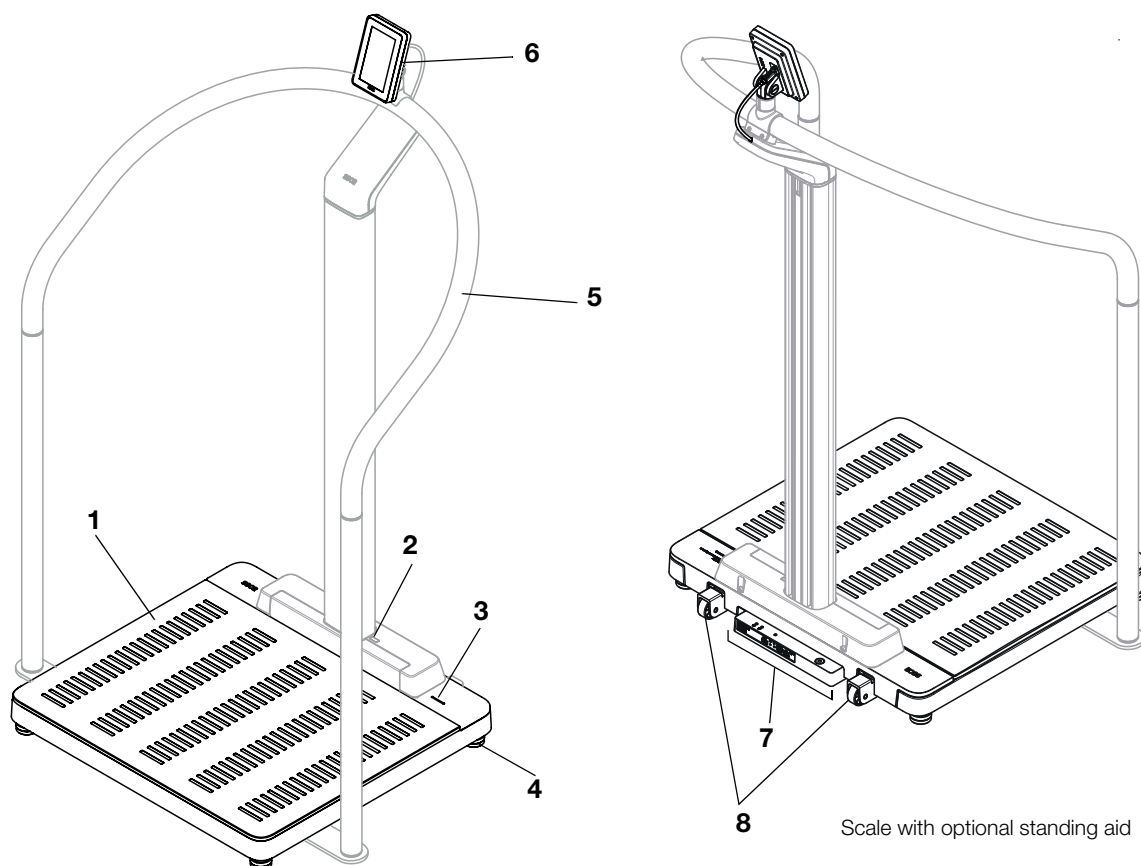

Item	Device component	Description
1	Weighing platform	<ul style="list-style-type: none"> <li>Bears the weight of the patient</li> <li>Illuminated foot silhouettes for weight measurement</li> </ul>
2	Cover for infrared interface	For functional expansions; no function at present
3	Workflow LED	<p>Indicates the status of data recording and data transmission (requirement: Connection to the <b>seca connect 103</b> software)</p> <ul style="list-style-type: none"> <li>Illuminated in green: Measurement procedure active</li> <li>Flashing green (approx. 5 seconds): Measuring results being sent to the EMR System (depending on setting)</li> <li>Illuminated in green (approx. 5 seconds): Measuring results successfully sent to the EMR System (depending on setting)</li> <li>Illuminated in red (approx. 5 seconds): Error during data transmission or measurement procedure</li> </ul> <p><b>NOTE</b> The data recorded and transmitted are specified in the <b>seca connect 103</b> software. If you have any queries, contact your administrator or hospital technician</p>
4	Foot screw	Used for precise alignment of the device (4 pcs)
5	Standing aid (optional)	<ul style="list-style-type: none"> <li>Compatible: Standing aid <b>seca 455</b> → <a href="#">Compatible seca products, page 138</a></li> <li>Used to support patients who are unable to stand securely</li> <li>Mounting option for the multifunctional display</li> </ul>
6	Multifunctional display	<p>Central control and display element</p> <ul style="list-style-type: none"> <li>→ <a href="#">Symbols on the multifunctional display (menu), page 87</a></li> </ul>

Item	Device component	Description
7	Connection panel	Used for power supply and data transmission → <a href="#">Interfaces, page 92</a>
8	Casters	Used for transporting over short distances (2 pcs)

## 4.2 Controls

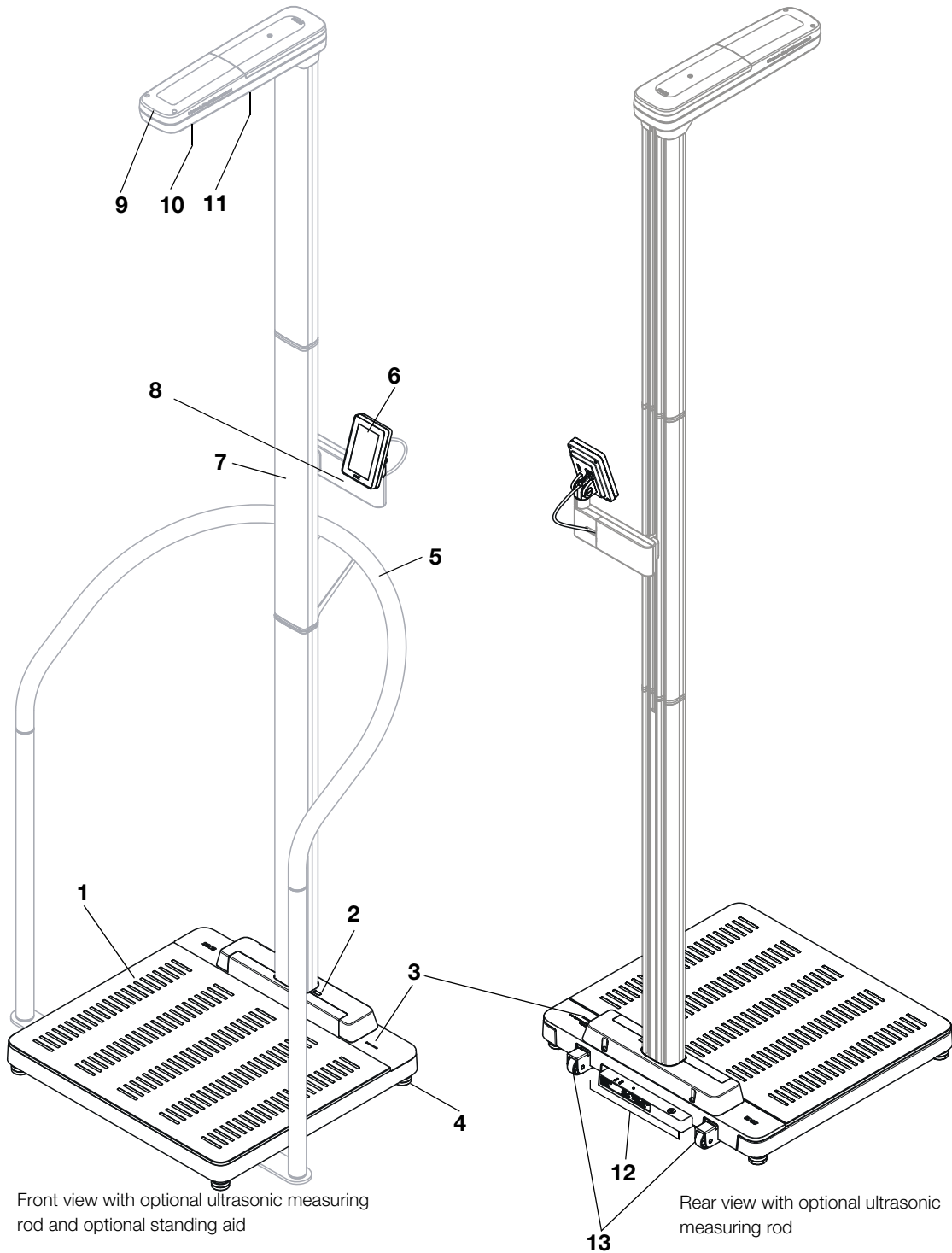

Item	Device component	Description
1	Weighing platform	<ul style="list-style-type: none"> <li>Bears the weight of the patient</li> <li>Illuminated foot silhouettes for weight and height measurement</li> </ul>







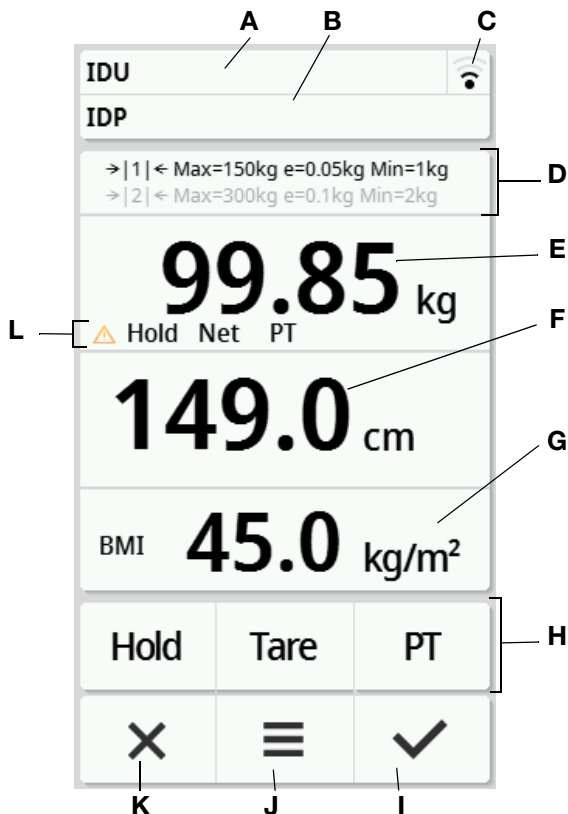

Item	Device component	Description
2	Cover for infrared interface	For functional expansions; no function at present
3	Workflow LED	<p>Indicates the status of data recording and data transmission (requirement: Connection to the <b>seca connect 103</b> software)</p> <ul style="list-style-type: none"> <li>• Illuminated in green: Measurement procedure active</li> <li>• Flashing green (approx. 5 seconds): Measuring results being sent to the EMR System (depending on setting)</li> <li>• Illuminated in green (approx. 5 seconds): Measuring results successfully sent to the EMR System (depending on setting)</li> <li>• Illuminated in red (approx. 5 seconds): Error during data transmission or measurement procedure</li> </ul> <p><b>NOTE</b> The data recorded and transmitted are specified in the <b>seca connect 103</b> software. If you have any queries, contact your administrator or hospital technician</p>
4	Foot screw	Used for precise alignment of the device (4 pcs)
5	Standing aid (optional)	<ul style="list-style-type: none"> <li>• Compatible: Standing aid <b>seca 455</b> → <a href="#">Compatible seca products, page 138</a></li> <li>• Used to support patients who are unable to stand securely</li> </ul>
6	Multifunctional display	<p>Central control and display element</p> <ul style="list-style-type: none"> <li>• → <a href="#">Symbols on the multifunctional display (menu), page 87</a></li> </ul>
7	Ultrasonic measuring rod (optional)	Compatible: Ultrasonic measuring rod <b>seca 257</b> → <a href="#">Compatible seca products, page 138</a>
8	Bracket for multifunctional display	Used to mount the multifunctional display (scope of delivery of the scale) on the measuring rod
9	Status LED	Indicates the operating status of the measuring rod
10	Ultrasound sensors	For measuring height
11	Loudspeaker	For voice output
12	Connection panel	Used for power supply and data transmission → <a href="#">Interfaces, page 92</a>
13	Casters	Used for transporting over short distances (2 pcs)

### 4.3 Symbols on the multifunctional display (main screen)

This section contains information about the display content in measuring mode. Information about the display content for configuration and administration is available here: → [Symbols on the multifunctional display \(menu\)](#), page 87.



Item	Display element	Description
A B	IDU IDP	Only on connection to an EMR System (via <b>seca connect 103</b> ): <ul style="list-style-type: none"> <li>• <b>IDU</b>: User name</li> <li>• <b>IDP</b>: Name and date of birth of the patient</li> <li>• Press the area to display the IDs in enlarged form</li> <li>• Not available on connection to <b>seca analytics 125</b></li> </ul>
C		WiFi connection status display: <ul style="list-style-type: none"> <li>•  WiFi activated, no signal</li> <li>•  Signal very weak</li> <li>•  Signal weak</li> <li>•  Signal good</li> <li>•  Signal optimal</li> </ul>
		LAN connection status display: <ul style="list-style-type: none"> <li>•  Deactivated</li> <li>•  Activated</li> <li>•  Not available</li> </ul>

Item	Display element	Description
D	Weighing technology data	<ul style="list-style-type: none"> <li>• Weighing ranges: →1 ←, →2 ←</li> <li>• Max: Maximum load per weighing range</li> <li>• e: Graduations (calibrated models)</li> <li>• d: Graduations (non-calibrated models)</li> <li>• Min: Minimum load per weighing range</li> </ul>
E	Display field <b>Weight</b>	Weight, units: <ul style="list-style-type: none"> <li>• Kilograms</li> <li>• Pounds (non-calibrated models)</li> </ul>
F	Display field <b>Height</b>	Height, for manual input: Press display; units: <ul style="list-style-type: none"> <li>• Centimeters</li> <li>• Feet/inch(es) (non-calibrated models)</li> </ul>
G	Display field "Body-Size-Indicator"	Available indicators: <ul style="list-style-type: none"> <li>• <b>BMI</b>: Body Mass Index (kg/m<sup>2</sup>)</li> <li>• <b>BSA</b>: Body Surface Area (m<sup>2</sup>)               <ul style="list-style-type: none"> <li>- <b>BSA</b> (Dubois)</li> <li>- <b>BSA</b> (Haycock)</li> <li>- <b>BSA</b> (Mosteller)</li> </ul> </li> <li>• : Waist circumference</li> <li>• Switch Body-Size-Indicator: Press display field</li> <li>• <b>BMI/BSA</b> are calculated automatically when the weight and height are available</li> </ul>
		<ul style="list-style-type: none"> <li>• : Enter waist circumference</li> <li>• Function can be activated/deactivated in the menu → <a href="#">Selecting BMI/BSA/Waist circumf., page 111</a></li> </ul>
H	Additional functions	<ul style="list-style-type: none"> <li>•  Additional function activated (here: <b>Hold</b>)</li> <li>•  Additional function deactivated</li> </ul>
I		<ul style="list-style-type: none"> <li>• Confirm measuring results and send to EMR System</li> <li>• Confirm manual inputs</li> </ul>
J		<ul style="list-style-type: none"> <li>• Press briefly: Open menu → <a href="#">Configuration, page 106</a></li> <li>• Press and hold (approx. 5 seconds): → <a href="#">Changing the device mode, page 106</a></li> </ul>
K		<ul style="list-style-type: none"> <li>• Clear measuring results</li> <li>• Clear manual inputs</li> <li>• Cancel automated procedures</li> </ul>
L	Extended weighing functions	<ul style="list-style-type: none"> <li>• : Non-verifiable function active</li> <li>• <b>Hold: Hold</b> function active</li> <li>• <b>NET: Tara</b> or <b>Pre-tare</b> function active</li> <li>• <b>PT: Pre-tare</b> function active</li> </ul>

#### 4.4 Symbols on the multifunctional display (menu)

This section contains information about the display content for configuration and administration. Information about the display content for measuring mode is available here: → [Symbols on the multifunctional display \(menu\), page 87](#).

The configuration options in the menu are dependent on the device mode selected:

→ [Changing the device mode, page 106](#)



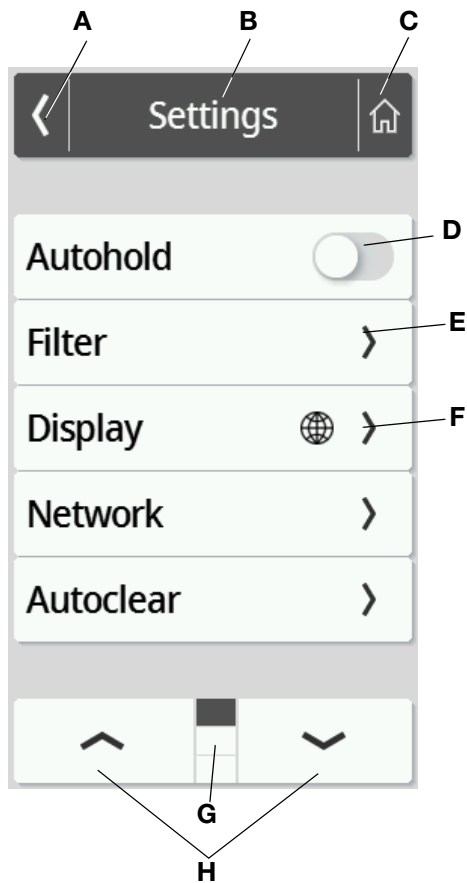







→ [Functions/device mode, page 134](#)









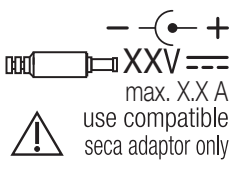

	Symbol	Description
A		Back to the higher menu level
B	Header	Indicates the current menu level
C		Back to the main screen
D		<ul style="list-style-type: none"> <li>• Press: Activate/deactivate function</li> <li>•  Function activated</li> <li>•  Function deactivated</li> </ul>
E		<ul style="list-style-type: none"> <li>• Submenu available</li> <li>• Setting options available</li> </ul>
F		Keys with this symbol lead to the <b>Display\Language</b> menu item
G		<ul style="list-style-type: none"> <li>• Pages per menu level; here: 3</li> <li>•  Current page is displayed; here: Page 1</li> </ul>
H		<ul style="list-style-type: none"> <li>• Select page in the menu</li> </ul>











## 4.5 Markings on the device and on the type plate

Text/symbol	Meaning
	Name and address of manufacturer, date of manufacture
	Model number
	Serial number, consecutive
<b>ProdID</b>	Product identification number, consecutive
<b>Approval Type</b>	Type designation of design approval
	Follow Instructions for Use (Devices with bioimpedance measurement)
	Follow Instructions for Use
	Device can tip over. Do not push or lean against it (devices with standing aid or measuring rod)
	Do not use device on individuals with cardiac pacemakers or implanted defibrillators (Devices with bioimpedance measurement)
	Medical electrical device, type BF
<b>IP21</b>	Type of protection in accordance with IEC 60529: <ul style="list-style-type: none"> <li>• Protection against ingress of solid foreign bodies with a diameter of over 12.5 mm</li> <li>• Protection against access with fingers</li> <li>• Protection against drips</li> </ul>
e	Value in units of measurement used to classify and verify a scale (verified models)
d	Value in mass unit which shows the difference between two consecutive display values (non-verified scales)
$\rightarrow x \leftarrow$	Active weighing range
	Class III scale in accordance with Directive 2014/31/EU (verified models)
	Device complies with EU standards and directives. <ul style="list-style-type: none"> <li>• <b>M</b>: Conformity label according to Directive 2014/31/EU governing non-automatic weighing instruments (verified models)</li> <li>• <b>20</b>: (Example: 2020) Year in which conformity verification was performed and the CE label was applied (verified model)</li> <li>• <b>0102</b>: Notified body metrology (verified models)</li> <li>• <b>0123</b>: Notified body medical products</li> </ul>
	Symbol of the US Federal Communications Commission (FCC)
FCC ID	Device license number from the Federal Communications Commission (FCC)

Text/symbol	Meaning
IC	Device license number from Industry Canada
	Type plate for power supply connection socket: <ul style="list-style-type: none"> <li>• Power supply polarity</li> <li>• Permitted supply voltage</li> <li>• Current consumption</li> </ul>
	LAN interface
	USB interface
	Power LED
	Network LED
	WPS button
	Reset key
	Interface for multifunctional display
	Do not dispose of device with household waste

#### 4.6 Markings on the packaging

	Protect from moisture
	Arrows indicate top of product. Transport and store in an upright position.
	Fragile Do not throw or drop.
	Permitted min. and max. temperature for transport and storage
	Permitted min. and max. moisture for transport and storage
	Permitted min. and max. air pressure for transport and storage
	Open packaging here
	Packaging material can be disposed of through recycling programs

## 5. STARTING UP THE DEVICE

### 5.1 Scope of delivery

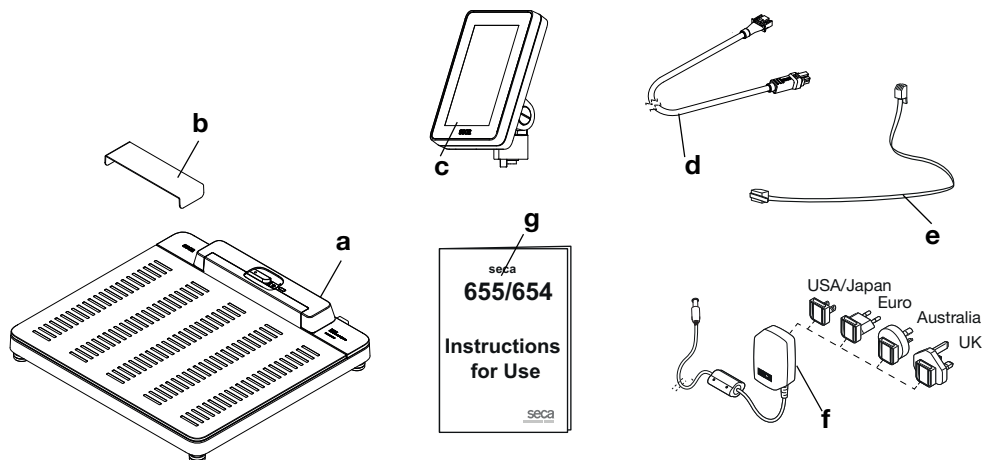

Item	Standard scope of delivery	Pcs.
<b>a</b>	Scale	1
<b>b</b>	Drip guard, transparent	1
<b>c</b>	Multifunctional display	1
<b>d</b>	Display cable	1
<b>e</b>	Network cable	1
<b>f</b>	Plug-in power supply unit with adapters	1
<b>g</b>	Instructions for use	1

## 5.2 Interfaces

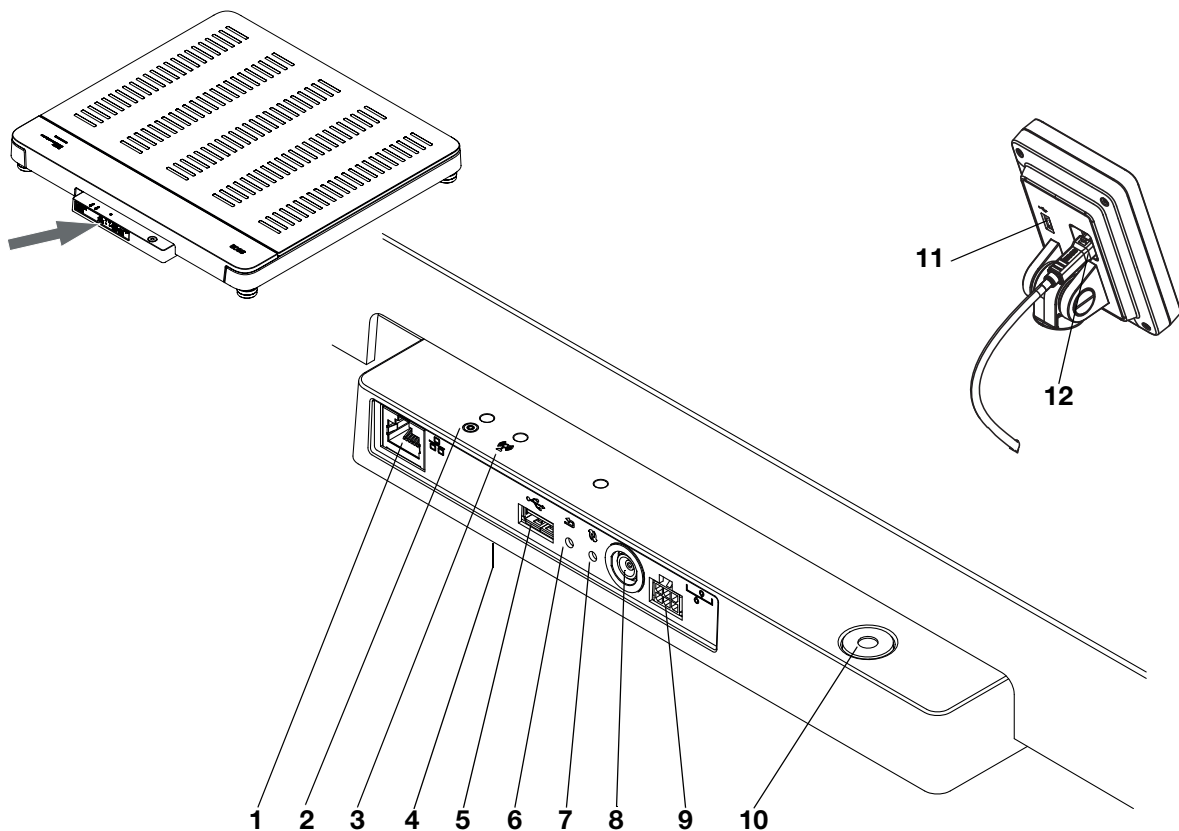

Item	Device component	Function
1	LAN interface	Used to connect the device to the EMR System in your institution (alternative to WiFi connection, <b>seca connect 103</b> software required).
2	Power LED	<ul style="list-style-type: none"> <li>• Illuminated in green: Device is ready for use</li> <li>• Illuminated in red: Device is defective</li> <li>• Flashes green: Device is active as access point</li> </ul>
3	Network LED	<ul style="list-style-type: none"> <li>• Flashes green: Network connection is being established</li> <li>• Illuminated in green: Network connection is established</li> <li>• Illuminated in red: Network connection is interrupted</li> </ul>
4	WiFi module (internal)	Used to connect the device to the EMR System in your institution (alternative to LAN connection, <b>seca connect 103</b> software required).
5	USB interface, weighing platform	Used to connect a barcode scanner → <a href="#">Optional accessories and spare parts, page 137</a>
6	Reset key	<ul style="list-style-type: none"> <li>• Press and hold (approx. 8 seconds): Reset settings</li> <li>• Press briefly (approx. 1 second): Activate/deactivate access point function</li> </ul>
7	WPS button	Establish WiFi connection via WPS
8	Power supply connection	Used to connect the plug-in power supply unit
9	Display socket	<ul style="list-style-type: none"> <li>• <b>seca 655/654</b>: Do not use this connection; see installation instructions for compatible seca products</li> </ul>
10	Spirit level	Indicates whether the device is horizontal
11	USB interface, multi-functional display	<ul style="list-style-type: none"> <li>• Used to connect a barcode scanner → <a href="#">Optional accessories and spare parts, page 137</a></li> <li>• <b>Recommended</b> if the multifunctional display is mounted directly on the device; accessory required: Scanner holder <b>seca 463</b> → <a href="#">Optional accessories and spare parts, page 137</a></li> </ul>

Item	Device component	Function
12	Display interface	<ul style="list-style-type: none"> <li>Used to supply the multifunctional display with power</li> <li>Used for data transmission between the multifunctional display and the device electronics</li> </ul>

### 5.3 Setting up the device

To achieve accurate measuring results, the floor at the setup location must be level and stable. Soft floors (wooden boards, for example) give under the patient's weight and falsify the measuring result.

- Place the device on a firm, level surface.  
You have the following options for continuing:
  - ▶ Device with ultrasonic measuring rod: Continue with step 2.
  - ▶ Devices without ultrasonic measuring rod: Continue with step 3.
- Mark the area shown in the illustration, e.g. using colored adhesive tape.

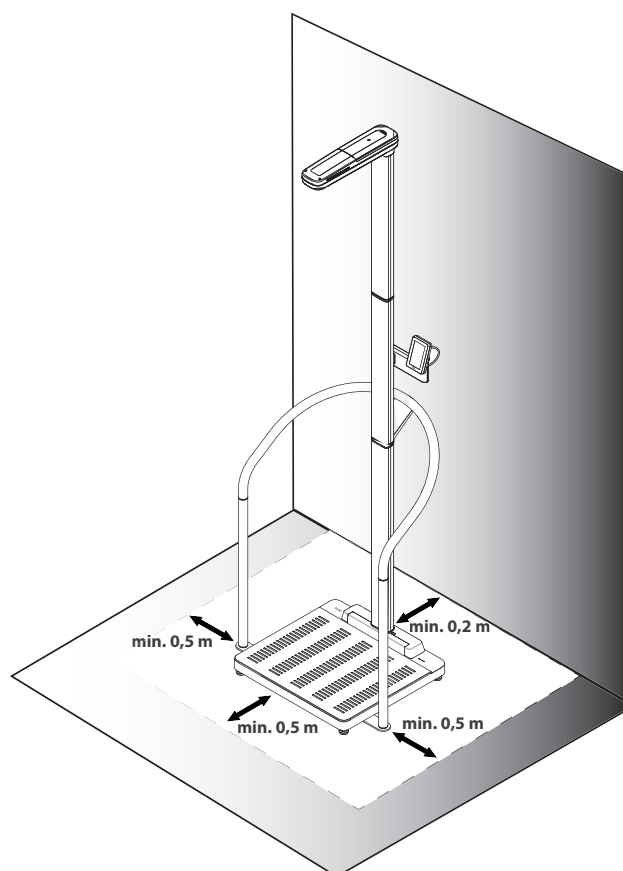

- Align the device by turning the foot screws.

The device is positioned horizontally when the air bubble of the spirit level is precisely in the middle of the circle.

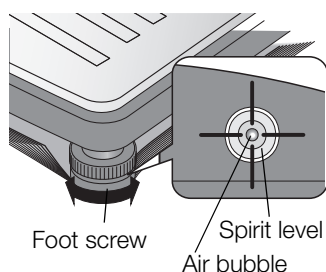

#### CAUTION!

##### Injury from a lack of stability

If the foot screws are screwed out too far, they can come loose from the device. The device is then unstable.

- ▶ Screw the foot screws out a maximum of 10 mm.
- ▶ If the device cannot be aligned horizontally with the screws screwed out as far as possible, the setup location is unsuitable. Set the device up in a suitable location.

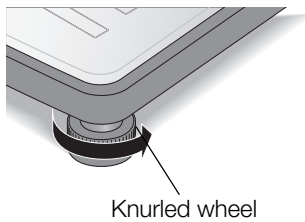

4. Tighten the knurled wheels in the direction of the arrow. The foot screws are secured against being adjusted.
5. Calibrate the ultrasonic measuring rod → [Calibrating ultrasonic height measurement, page 109](#).

## 5.4 Connecting a barcode scanner (optional)

A barcode scanner can be connected to the USB interface of the weighing platform.

The barcode scanner is required for the following functions:

- **Configuration:** Define network data in the **seca connect 103** software and transfer them to the device using the QR code: → [Setting up network functions, page 115](#)
- **Operation:** Record patient and user IDs for transmitting measuring results to an EMR System: → [Completing the measurement procedure, page 105](#)

### **WARNING!** **Patient hazard**

- ▶ Route the connecting cable so that patients cannot become caught or strangle themselves in it.
- ▶ Route the connecting cable so that patients and users cannot stumble.

### **NOTE**

- Observe the maximum permitted current consumption of the barcode scanner → [General technical data, page 135](#).
- Use only barcode scanners recommended by seca → [Optional accessories and spare parts, page 137](#).

To connect a barcode scanner, proceed as follows:

1. Make sure that the device is disconnected from the power supply.
2. Plug the USB connector of the barcode scanner into the USB socket of the multifunctional display.

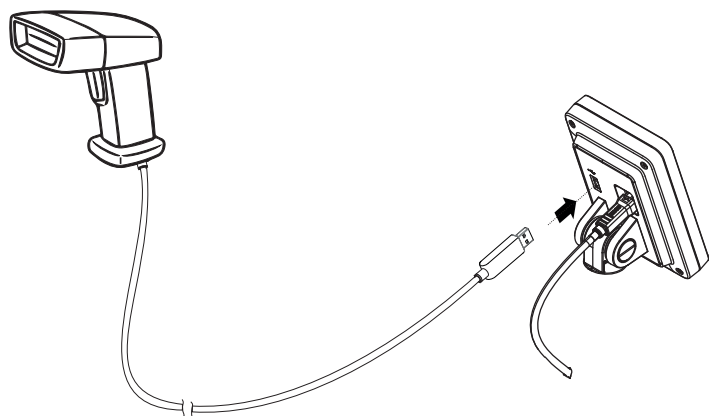

3. Hang the barcode scanner in a suitable holder (e.g. scanner holder **seca 463** → [Optional accessories and spare parts, page 137](#)).

**NOTICE!****Incorrect measurement as a result of force shunt**

The barcode scanner and scanner holder lie in the weighing-sensitive area of the device. If the barcode scanner is not placed back in the scanner holder after scanning, the measuring result is falsified.

- ▶ Place the scanner back in the scanner holder after each scanning procedure.

4. Establish the power supply → [Establishing the power supply, page 95](#).

## 5.5 Establishing the power supply

The device is supplied with power by a plug-in power supply unit.

**NOTICE!****Damage to device as a result of excessive voltage**

Commercially available power supply units may deliver a higher voltage than that stated on them. The device may overheat, catch fire, melt or short-circuit.

- ▶ Use only the original seca plug-in power supply unit with controlled 12 V output voltage → [Optional accessories and spare parts, page 137](#).

1. Plug the adapter required for your power supply into the power supply unit.

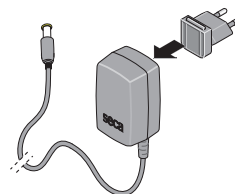

2. Insert the device connector of the power supply unit into the power supply connection socket of the device.
3. Plug the power supply unit into a power supply socket.

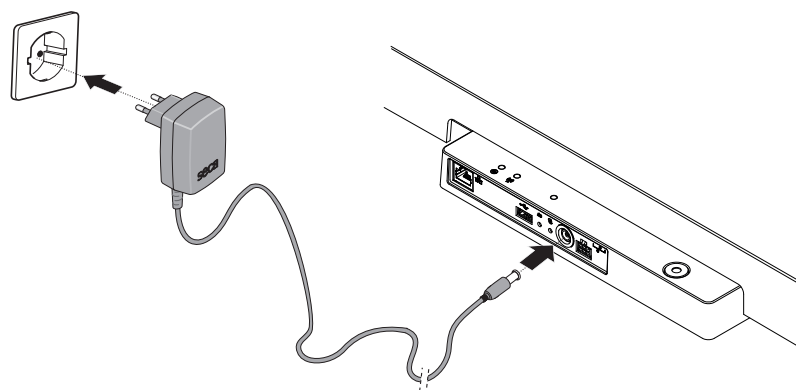

4. Perform a function check → [Function check, page 124](#).

## 5.6 Installing the drip guard

**NOTICE!****Damage to device due to the ingress of fluids**

Damage may occur to the device if dripping water or other fluids enter the device via the connection panel.

- ▶ Only operate the device with the drip guard installed.

1. Connect all cables as described in these instructions for use and in the installation instructions for the compatible products.

2. Position the drip guard on the connection panel as shown in the illustration.
3. Push the drip guard beneath the weighing platform up to the stop.

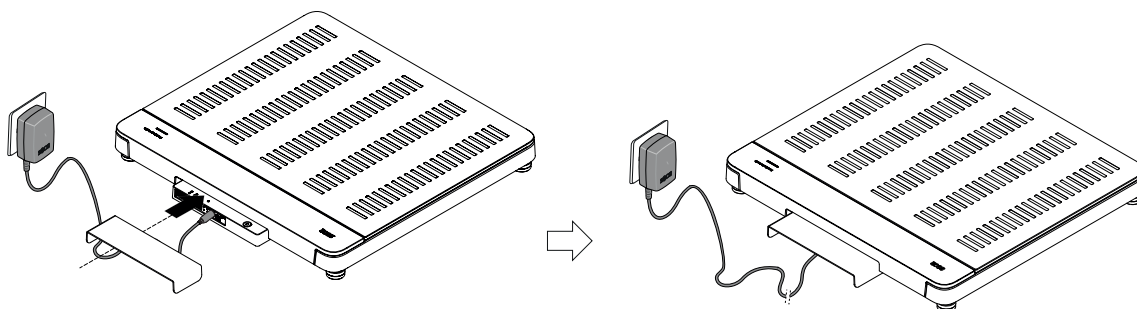

## 5.7 Adapting device settings

You have the following options for setting the device up for different usage situations:

- → [Changing the device mode, page 106](#)
- → [Calling up/exiting a menu, page 107](#)
- → [Setting up network functions, page 115](#)
- → [Calibrating ultrasonic height measurement, page 109](#) (device-dependent)

## 5.8 Transporting the device

The device is equipped with two casters which enable transport over short distances.



### **CAUTION!** **Risk of injury and damage to device**

If the device is equipped with a measuring rod, it must be tilted extensively for transport. The great height of the device can result in injuries and damage to the device.

- ▶ Make sure that there are no other persons in the immediate vicinity.
- ▶ Make sure that there are no objects in the in the immediate vicinity.

1. Remove the drip guard.
2. Disconnect all of the device's cable connections (e.g. power supply, network).
3. Tilt the device until it can be moved freely on the casters.

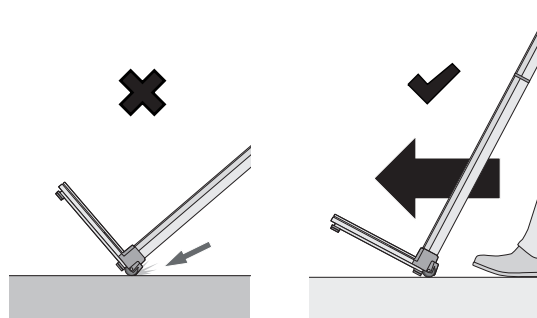

4. Transport the device to its new setup location.
5. Set up the device → [Setting up the device, page 93](#).
6. Re-establish all cable connections.
7. Install the drip guard.



## 6. OPERATION

### **WARNING!** **Injury from falls**

- ▶ Ensure that the device is positioned firmly and level.
- ▶ Route connecting cables (if present) in such a way that neither user nor patient can trip over them.
- ▶ The device is not intended for supporting patients when getting up e.g. from a wheelchair. Assist people with limited motor skills when they are getting up, e.g. from a wheelchair.
- ▶ Make sure that the patient does not step onto and off the weighing platform right at the edges.
- ▶ Make sure that the patient steps onto and off the weighing platform slowly and safely.

### **WARNING!** **Danger of slipping**

- ▶ Ensure that the weighing platform is dry before the patient steps onto it.
- ▶ Ensure that the patients feet are dry before he or she steps onto the weighing platform.
- ▶ Make sure that the patient steps onto and off the weighing platform slowly and safely.

### **NOTE**

The availability of some functions is dependent on the device mode. If you require functions that are not available in the current device mode, ask your administrator or hospital technician whether the device mode can be changed.

### 6.1 Activating the multifunctional display

Device mode	Function available
<b>Basic</b>	•
<b>Advanced</b>	•
<b>Expert</b>	•
<b>Service</b>	•

The multifunctional display goes off after a set period of time (→ [Setting the standby time, page 112](#)). The seca logo is displayed (screensaver).

### **WARNING!** **Electric shock**

The device is not equipped with an on/off switch and is not de-energized when the display goes off.

- ▶ Remove the power supply connector if the device has to be de-energized, e.g. for hygiene processing or maintenance work.
- ▶ Press the multifunctional display to activate it.  
The main screen is displayed.  
The device is ready for operation.

## 6.2 Measuring weight

Device mode	Function available
Basic	•
Advanced	•
Expert	•
Service	•



### CAUTION! Patient hazard! Injury from falling

Persons with limited mobility can fall when stepping onto the weighing platform.

- ▶ Support people with limited mobility when they step onto the scale.

1. Make sure that there is no load on the weighing platform.
2. Ask the patient to step onto the weighing platform.
3. Ask the patient to keep still.
4. Read off the measuring result.



## 6.3 Entering the height manually

Device mode	Function available
Basic	•
Advanced	•
Expert	•
Service	•

1. Press the **Height** field.
2. Enter the height.
3. Press the key to confirm your entry.

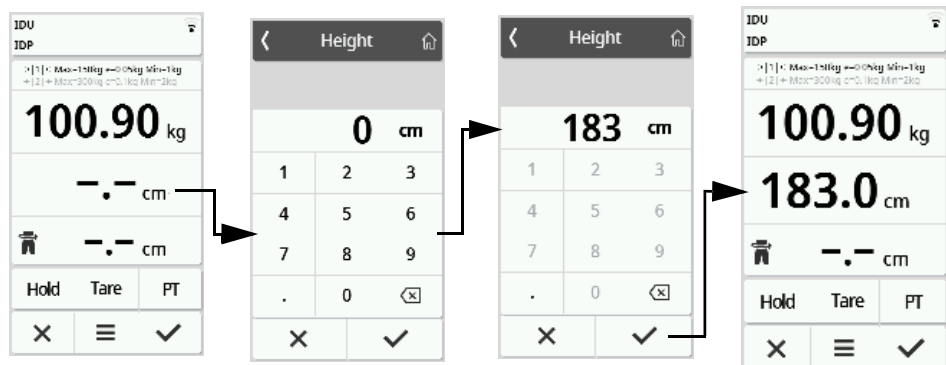

4. Press the key to clear your entry.

## 6.4 Measuring weight and height (devices with ultrasonic measuring rod)

Device mode	Function available
Basic	•
Advanced	•
Expert	•
Service	•



### CAUTION!

#### Patients can be injured if they fall

Persons with limited mobility can fall when stepping onto the weighing platform.

- ▶ Support people with limited mobility when they step onto the scale.

### WARNING!

#### Incorrect measurement due to reflections

If there are objects or people in the immediate vicinity of the device, incorrect measurements will result.

- ▶ Ensure that there are no objects or people within 0.5 meter of the front or side of the device during the measuring process.
- ▶ Ensure that the device is at least 0.2 meter away from the wall.
- ▶ Ensure that the patient is not wearing any kind of hair accessory on top of the head.

The measurement procedure described on the following is based on the factory settings. Information about configuration options can be found here:

→ [Configuring voice guidance, page 119](#).

1. Make sure that there is no load on the weighing platform.
2. If necessary, press the multifunctional display screen to “wake” the device from standby.
3. Make sure that the Status LED on the ultrasound head and the silhouettes on the weighing platform light up.

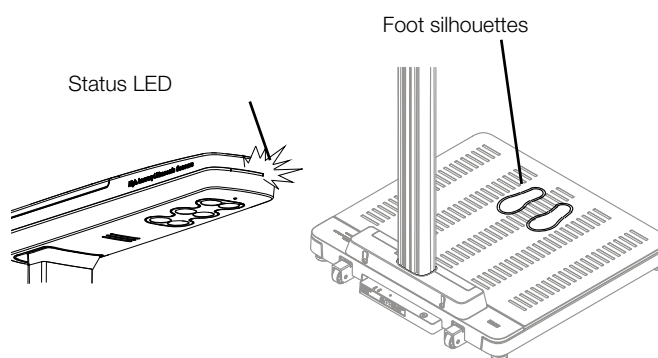

4. Make sure that the patient steps forward onto the weighing platform and adopts an upright posture.
5. Make sure that the patient stands on the illuminated foot silhouettes.
6. Ask the patient to follow the instructions given by the device. The device determines the patient's weight and height.

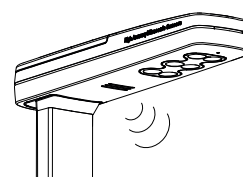



7. Read off the measuring result.
8. You have the following options for continuing:
  - ▶ Completing the measurement → [Completing the measurement procedure, page 105](#)
  - ▶ Clearing measuring results: Press **X** key

## 6.5 Using extended weighing functions

### Taring additional weight (tare)

Device mode	Function available
<b>Basic</b>	–
<b>Advanced</b>	•
<b>Expert</b>	•
<b>Service</b>	•

Use the **Tare** function to prevent an additional weight (e.g. a towel) from affecting the patient's weight value.

#### NOTICE!

##### Incorrect measurement as a result of force shunt

If an additional weight, e.g. a large towel, touches the surface on which the scale is stood, the weight will not be measured correctly.

- ▶ Make sure that additional weights are only placed on the scale's weighing platform.

1. To activate the **Tare** function, proceed as follows:
  - a) Place an additional weight (here: 1 kg) onto the weighing platform.
  - b) Press the **Tare** key.
  - c) Wait until the value **0.00** and the message "**NET**" are displayed.

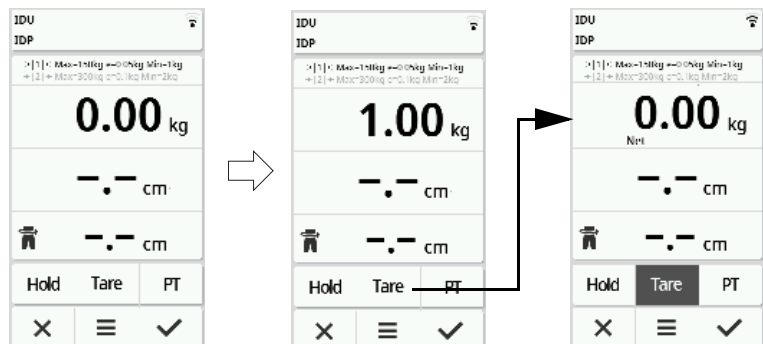

2. Weigh the patient → [Measuring weight, page 98](#).
3. Read off the measuring result.  
The additional weight is deducted automatically.

4. To deactivate the function, proceed as follows:
  - a) Remove the weight from the weighing platform
  - b) Press the **Tare** key
  - c) Wait until the **NET** message goes off and the additional weight is displayed
  - d) Remove the additional weight from the weighing platform

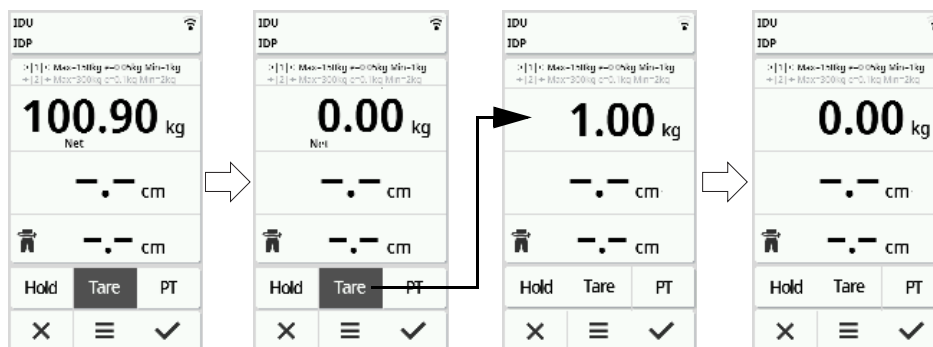
**NOTE**

The maximum weight which can be displayed is reduced by the weight of the objects which have been tared.

### Permanently displaying the weight (Hold)

Device mode	Function available
<b>Basic</b>	–
<b>Advanced</b>	•
<b>Expert</b>	•
<b>Service</b>	•

When the **Hold** function is activated, the weight is still displayed after the weight has been removed from the scale. This enables you to attend to the patient before recording the weight value.

1. Make sure that there is no load on the scale.
2. Ask the patient to step onto the scale.
3. Press the **Hold** key.
4. Wait until the weighing value has stopped flashing. The **Hold** message appears.

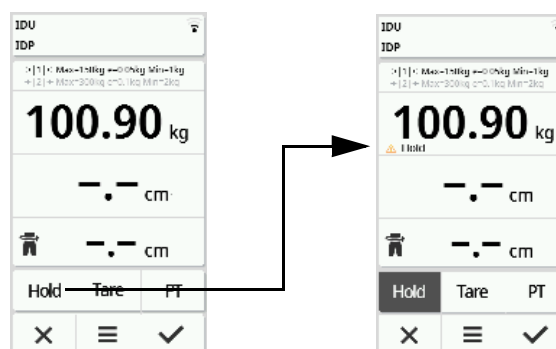

5. To deactivate the function, press the **Hold** key. The **Hold** message is no longer displayed.

**NOTE**

When the **Autohold** function is activated, the weight value is automatically displayed permanently as soon as a stable measuring result has been achieved → [Activating the Autohold function, page 108](#).

**Devices with measuring rod:  
Permanently displaying the weight  
and height (Hold)**

Device mode	Function available
<b>Basic</b>	–
<b>Advanced</b>	•
<b>Expert</b>	•
<b>Service</b>	•

When the **Hold** function is activated, the weight and height are still displayed after the weight has been removed from the scale. This enables you to attend to the patient before recording the measuring results.

1. Make sure that there is no load on the scale.
2. Ask the patient to step onto the scale.
3. Wait until height measurement has been completed and, if the device is set accordingly, the measuring results have been announced.
4. Press the **Hold** key.

The **Hold** message is displayed.

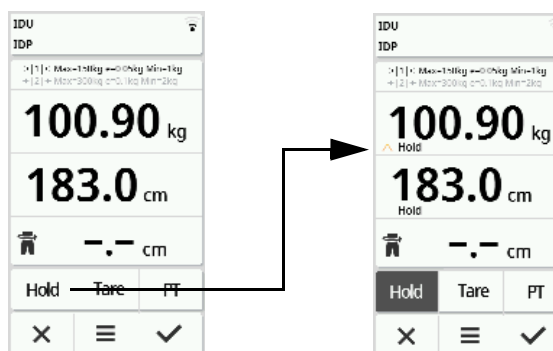

5. To deactivate the function, press the **Hold** key.  
The  $\triangle$  symbol and the **Hold** message are no longer displayed.

**NOTE**

If the **Autohold** function is activated, the weight and height are automatically displayed permanently as soon as stable measured values have been achieved → [Activating the Autohold function, page 108](#).

**Permanently storing additional  
weight (pre-tare)**

Device mode	Function available
<b>Basic</b>	–
<b>Advanced</b>	•
<b>Expert</b>	•
<b>Service</b>	•

The **Pre-tare** function can be used to permanently save an additional weight and automatically subtract it from a measuring result, e.g. a flat-rate figure for shoes and clothing.

1. To activate the **Pre-tare** function, proceed as follows:
  - a) Remove the weight from the weighing platform
  - b) Press the **PT** key
  - c) Enter the value
  - d) Confirm the value with the  key

The set additional weight (here: 1.5 kg) is displayed with a minus sign in front.

The messages “**NET**” and “**PT**” are displayed.



2. Ask the patient to step onto the scale.  
The patient's weight is displayed.  
The saved additional weight has been deducted automatically.
3. To deactivate the function, proceed as follows:
  - a) Remove the weight from the weighing platform
  - b) Press the **PT** key
  - c) Clear the value with the  key

The set additional weight is no longer displayed.  
The function is deactivated.

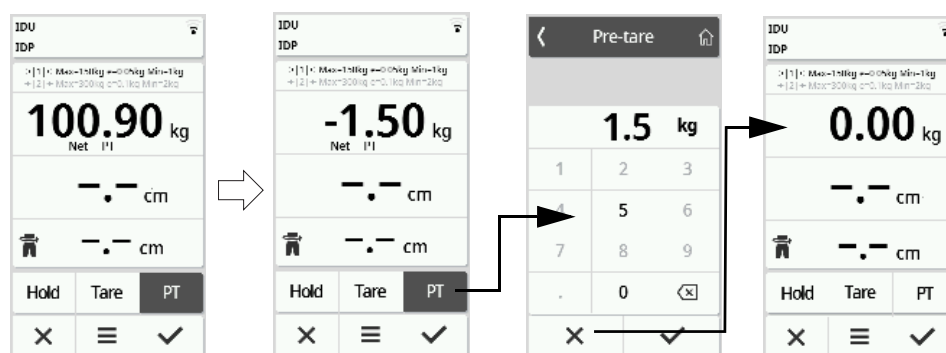

### Automatic switchover of weighing range

After the scale is switched on, weighing range 1 is active. If a particular weight value is exceeded, the scale automatically switches to weighing range 2.

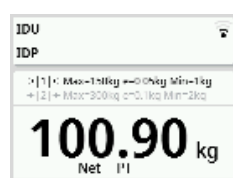

- ▶ To switch back to weighing range 1, completely remove the weight from the scale.  
Weighing range 1 is active again.

## Automatic calculation of BMI or BSA

Device mode	Function available
Basic	•
Advanced	•
Expert	•
Service	•

The device automatically calculates the Body Mass Index (**BMI**) or the Body Surface Area (**BSA**) according to its default setting → [Selecting BMI/BSA/ Waist circumf.](#), page 111.

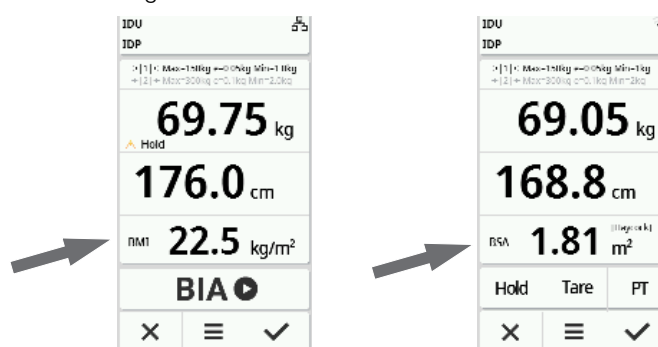

- ▶ Determine the weight and height of the patient.
  - ▶ → [Measuring weight](#), page 98
  - ▶ → [Entering the height manually](#), page 98
  - ▶ → [Measuring weight and height \(devices with ultrasonic measuring rod\)](#), page 99

Either the **BMI** or the **BSA** is calculated automatically according to the default setting.



## Entering waist circumference

When the  symbol is visible on the main screen (→ [Selecting BMI/BSA/ Waist circumf.](#), page 111), you can enter the waist circumference of the patient and send it to your EMR System or the **seca analytics 125** software together with further measuring results.

1. Press the  display field.
2. Enter the waist circumference.
3. Confirm the entry with the  key.

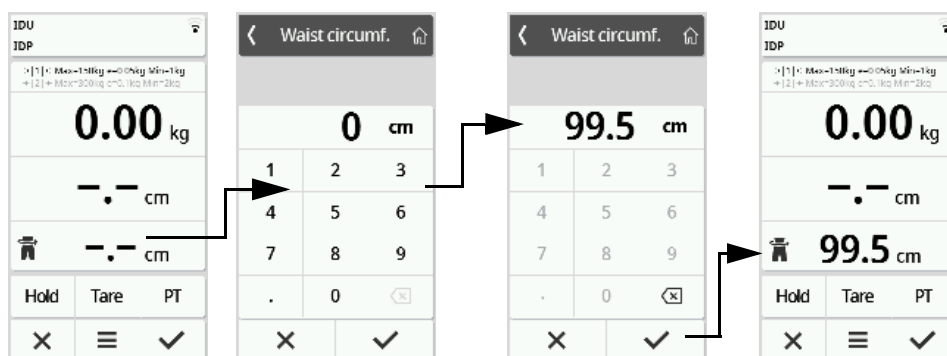



## 6.6 Completing the measurement procedure

### NOTICE!

#### Incorrect measuring results

On devices that are equipped with a scanner holder, the barcode scanner and the barcode scanner holder lie in the weighing-sensitive area and can falsify the measuring result.

- ▶ Hang the barcode scanner in the holder.

### Devices with connection to an EMR System

To complete a measurement on devices that are connected to an EMR System, proceed as follows:

1. Make sure that the displayed measured values are plausible.
2. Scan the patient and/or user ID.

The device indicates whether the scanned IDs are correct:

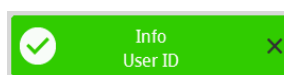

User ID OK



Patient ID OK

### NOTE

Whether and the point in the measurement procedure at which the IDs have to be scanned is defined when connecting the device to your EMR System. If you have any queries in this regard, contact your administrator or hospital technician.

3. Press the ✓ key.  
The measuring results are submitted to the EMR System and are assigned to the electronic patient file.

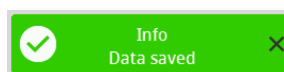

Data have been submitted to the EMR System

The device is ready for the next measurement.

### Devices with connection to the seca analytics 125 software

To complete a measurement on devices that are connected to the **seca analytics 125** software, proceed as follows:

1. Press the ✓ key.  
The **Date of birth** dialog window appears.
2. Enter the patient's date of birth.
3. Press the ✓ key.  
The measuring results are submitted to the **seca analytics 125** software.

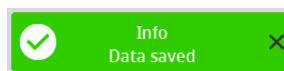

Data have been submitted to the EMR System

The device is ready for the next measurement.

### Standalone devices

To complete a measurement on devices that are not connected to an EMR System or the **seca analytics 125** software, proceed as follows:

1. Make sure that the displayed measured values are plausible.
2. Transfer the displayed measured values to the patient file.
3. Press the ✕ key.  
Measured values and manual inputs are cleared.  
The device is ready for the next measurement.

## 7. CONFIGURATION

### NOTE



- The functions described in this part of the instructions for use are exclusively intended for administrators and hospital technicians.
- This part of the user documentation contains information about configuring the device for measuring mode and for integration into a PC network.
- Integrating this device into a PC network containing other devices may lead to previously unknown risks for patients, operators or third parties. It is the responsibility of the operating company to determine, analyze, evaluate, and control these risks.

### 7.1 Basic functions

**Changing the device mode** The following device modes are available for setting the device up for different usage situations:



Mode	Functions	Use	Recommended user group
<b>Basic</b>	<ul style="list-style-type: none"> <li>• Measurement functions:               <ul style="list-style-type: none"> <li>- Performing a measurement</li> <li>- Reading off results</li> </ul> </li> <li>• No menu access</li> </ul>	Guided measurements	Hospital personnel
<b>Advanced</b>	<ul style="list-style-type: none"> <li>• Measurement functions:               <ul style="list-style-type: none"> <li>- Performing a measurement</li> <li>- Reading off results</li> <li>- Using additional functions</li> </ul> </li> <li>• Menu:               <ul style="list-style-type: none"> <li>- Limited device configuration</li> </ul> </li> </ul>	Guided measurements	Hospital personnel
<b>Expert</b>	<ul style="list-style-type: none"> <li>• Measurement functions:               <ul style="list-style-type: none"> <li>- Performing a measurement</li> <li>- Reading off results</li> <li>- Using additional functions</li> </ul> </li> <li>• Menu:               <ul style="list-style-type: none"> <li>- Device configuration</li> <li>- Network configuration</li> </ul> </li> </ul>	<ul style="list-style-type: none"> <li>• Guided measurements</li> <li>• Configuring the device</li> <li>• Network connection</li> </ul>	<ul style="list-style-type: none"> <li>• Hospital personnel</li> <li>• Hospital technicians</li> <li>• IT administrators</li> </ul>
<b>Service</b>	<ul style="list-style-type: none"> <li>• Measurement functions:               <ul style="list-style-type: none"> <li>- Performing a measurement</li> <li>- Reading off results</li> <li>- Using additional functions</li> </ul> </li> <li>• Menu:               <ul style="list-style-type: none"> <li>- Device configuration</li> <li>- Network configuration</li> <li>- Additional service functions</li> </ul> </li> </ul>	Service	Authorized service technicians

To select a device mode, proceed as follows:

1. Press and hold the  key (approx. 5 sec.) until the **Device mode** menu appears.  
The current device mode is displayed.
2. Press the desired device mode.  
The function is active.
3. Press the  key in the header.  
The main screen is displayed.

**Calling up/exiting a menu**

To call up the menu, proceed as follows:

1. Press the  key.  
The **Settings** menu is displayed.
2. To exit the menu, press the  key.  
The main screen is displayed.

**NOTE**



No menu access is possible in the **Basic** device mode.

**Accessing the PDF version of the instructions for use (QR code)**

Device mode	Function available
<b>Basic</b>	-
<b>Advanced</b>	•
<b>Expert</b>	•
<b>Service</b>	•

You can scan a QR code which can be used to access the PDF version of these instructions for use and load them e.g. onto your smartphone or tablet PC.

To scan the QR code, proceed as follows:

1. Press the  key.  
The **Settings** menu is displayed.
2. Press the  or  key until the **Manual** menu item is displayed.
3. Press the **Manual** item.  
A QR code is displayed.



4. Scan the QR code (e.g. with your smartphone or tablet).  
This takes you to the [www.seca.com/support](http://www.seca.com/support) website, where you can download the instructions for use.

## 7.2 Measuring

### Activating the Autohold function

Device mode	Function available
<b>Basic</b>	-
<b>Advanced</b>	•
<b>Expert</b>	•
<b>Service</b>	•

If you activate the **Autohold** function, it is no longer necessary to manually activate the **Hold** function for each individual measurement procedure.





On devices with a measuring rod, the setting also applies to the height display.

#### NOTE

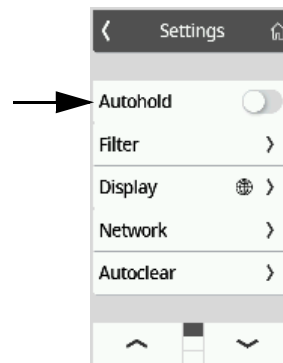
This function is activated at the factory on some models. The function can be deactivated.

1. Press the  key.  
The **Settings** menu is displayed.





2. Press the  or  key until the **Autohold** menu item is displayed.
3. Select the desired setting:
  -  Function activated
  -  Function deactivated
4. To exit the menu, press the  key.

### Setting filter

Device mode	Available
<b>Basic</b>	-
<b>Advanced</b>	•
<b>Expert</b>	•
<b>Service</b>	•

The **Filter** function can be used to avoid interferences during weight determination. The selected setting has the following influences on measurements with the **Hold/Autohold** function activated:

- Sensitivity with which the weight display reacts to patient movements
- Period of time until a weight value is displayed permanently.

1. Press the  key.  
The **Settings** menu is displayed.
2. Press the  or  key until the **Filter** menu item is displayed.

- Press the **Filter** item.  
The current setting is displayed.

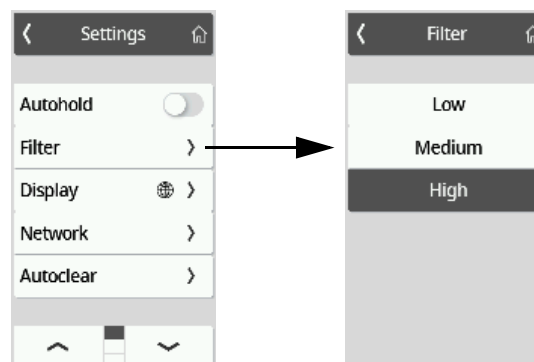

Filter	Weight determination
Low	Fast
Medium	Medium
High	Slow

- Press the desired filter level.  
The setting is active.

#### NOTE

With the **Low** setting, it may occur that no weight value is displayed permanently despite the activated **Hold** function in the case of patients who are not very steady on their feet.

## Calibrating ultrasonic height measurement

Device mode	Function available
Basic	-
Advanced	-
Expert	•
Service	•



Before performing a measurement with the device for the first time, height measurement must be calibrated. Repeat this calibration at least once per year.

The automated calibration procedure consists of two steps:

- Calibration over the entire measuring range
- Calibration against a calibration rod (included in the scope of delivery of the measuring rod).

#### NOTE

Make sure that there are no objects or people in the immediate vicinity of the device during the calibration procedure → [Setting up the device, page 93](#).

- Press the  key.  
The **Settings** menu is displayed.
- Press the  or  key until the **Height meas.** menu item is displayed.
- Press the **Height meas.** menu item.

- Press the **Ultras. calibration** menu item.  
The **Ultras. calibration** dialog is displayed:

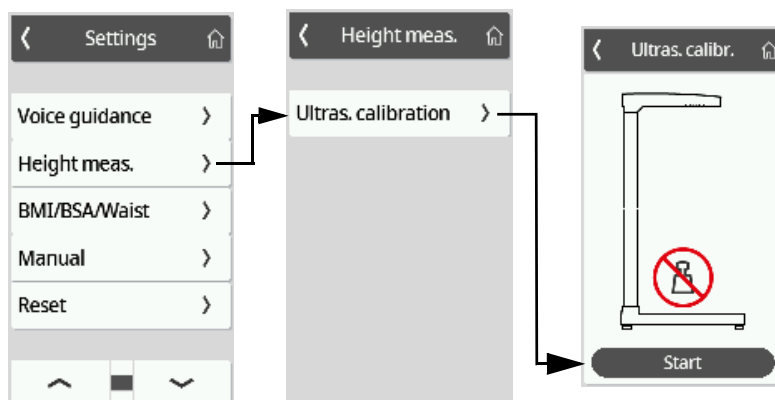

- Make sure that there is no load on the scale.
- Step back from the measuring device (distance approx. 0.5 m).
- Press the **Start** key.  
The first step of the calibration procedure starts.
- Wait until the first part of the calibration procedure has been completed.  
The device requests you to place the calibration rod onto the weighing platform:

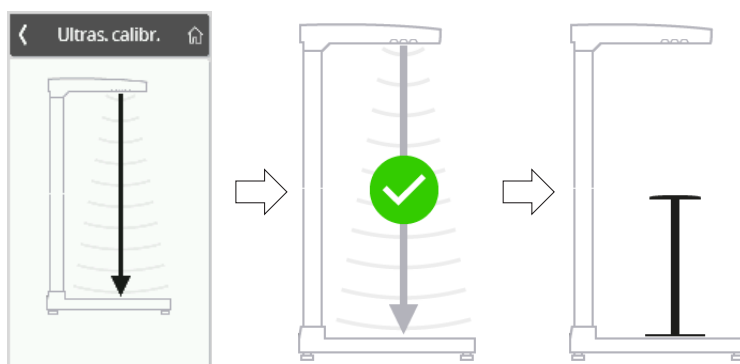

- Place the calibration rod centrally onto the illuminated foot silhouettes of the weighing platform.  
The second step of the calibration procedure starts:
- Wait until the second part of the calibration procedure has been completed.  
The main screen is displayed again.

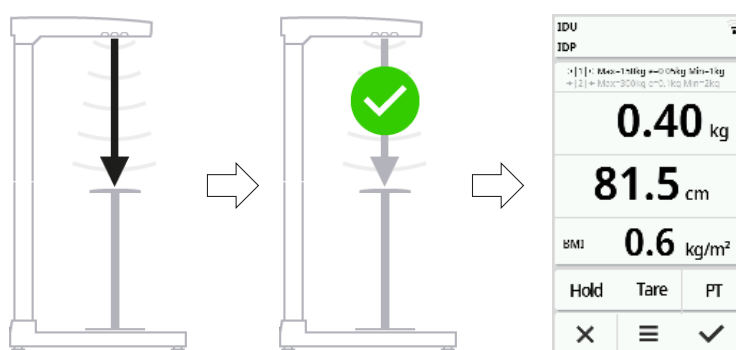
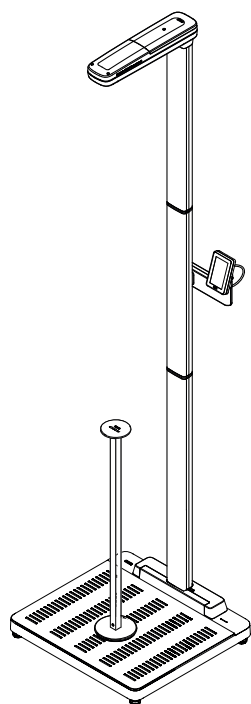

- Remove the calibration rod from the weighing platform.  
The device is ready to measure.

## Selecting BMI/BSA/Waist circumf.



Device mode	Function available
<b>Basic</b>	-
<b>Advanced</b>	-
<b>Expert</b>	•
<b>Service</b>	•

You can specify whether the device calculates the Body Mass Index (**BMI**) or the Body Surface Area (**BSA**) as soon as the patient's weight and height are available.

The device can also be set so that the waist circumference (**Waist circumf.**) can be entered manually.

### NOTE

If the **Waist circumf.** setting is selected, automatic BMI/BSA calculation is not possible.

1. Press the  key.  
The **Settings** menu is displayed.
2. Press the  or  key until the **BMI/BSA/Waist** menu item is displayed.
3. Press the **BMI/BSA/Waist** item.
4. Press the desired setting:  
The setting is active.

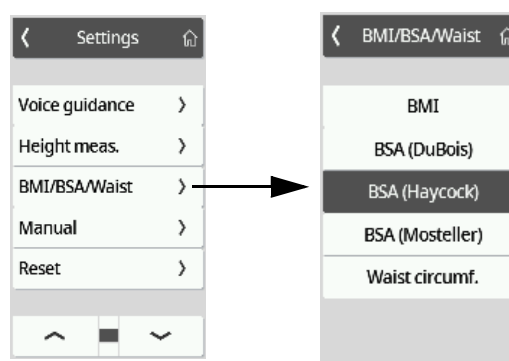



## 7.3 Adjusting display settings

### Setting the display language

Device mode	Function available
<b>Basic</b>	-
<b>Advanced</b>	•
<b>Expert</b>	•
<b>Service</b>	•

The display language can be set

1. Press the  key.  
The **Settings** menu is displayed.
2. Press the  or  key until the **Display** menu item is displayed.
3. In the **Display** menu, select the **Language** item.

- Press the desired filter language.  
The setting is active.

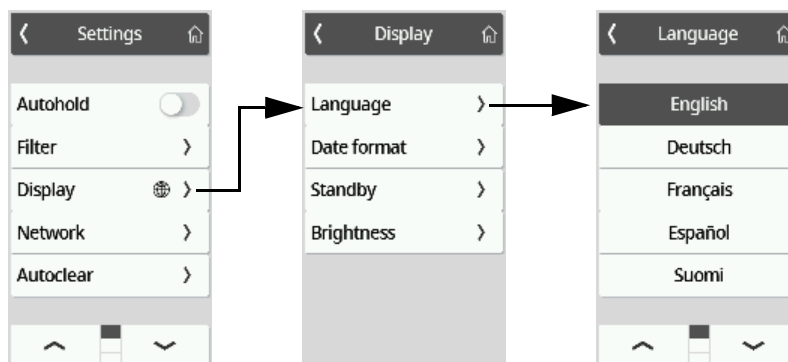

- To exit the menu, press the key.

### Setting the date format

Device mode	Function available
<b>Basic</b>	-
<b>Advanced</b>	•
<b>Expert</b>	•
<b>Service</b>	•

The format in which the patient's date of birth is displayed can be set.

- Press the key.  
The **Settings** menu is displayed.
- Press the or key until the **Display** menu item is displayed.
- In the **Display** menu, select the **Date format** item.
- Press the desired date format.  
The setting is active.

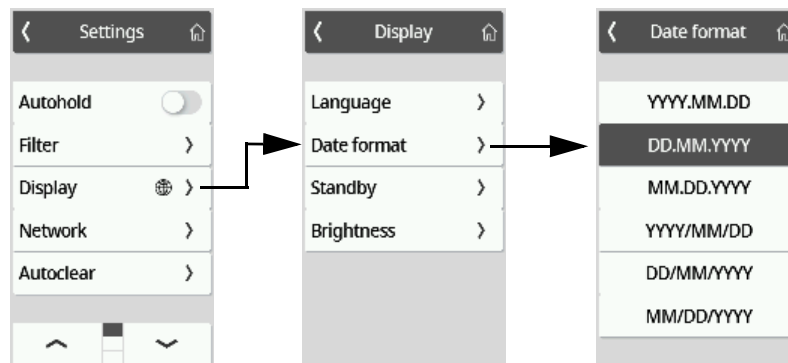

- To exit the menu, press the key.

### Setting the standby time

Device mode	Function available
<b>Basic</b>	-
<b>Advanced</b>	•
<b>Expert</b>	•
<b>Service</b>	•

The period of time after which the multifunctional display goes off (standby) can be set.







**WARNING!**  
**Electric shock**

The device is not de-energized when the display goes off.

- ▶ The device is not equipped with an on/off switch. Remove the power supply connector if the device has to be de-energized, e.g. for hygiene processing or maintenance work.

1. Press the  key.  
The **Settings** menu is displayed.
2. Press the  or  key until the **Display** menu item is displayed.
3. In the **Display** menu, select the **Standby** item.
4. Press the desired setting.  
The setting is active.  
The display goes off after the set period of time.

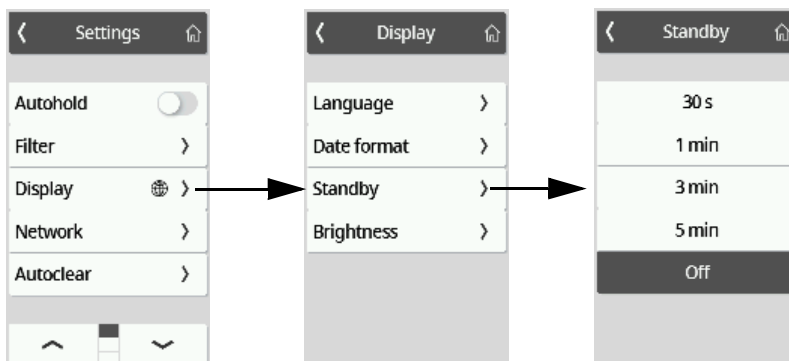

**NOTE**



If the **Off** setting is selected in the **Standby** menu, the multifunctional display remains permanently active.

5. To exit the menu, press the  key.

**Setting the display brightness**

Device mode	Function available
<b>Basic</b>	–
<b>Advanced</b>	•
<b>Expert</b>	•
<b>Service</b>	•

The display brightness can be adjusted in stages (0 = off, 9 = max).

1. Press the  key.  
The **Settings** menu is displayed.
2. Press the  or  key until the **Display** menu item is displayed.
3. In the **Display** menu, select the **Brightness** item.

4. Adjust the brightness:
  - ▶ Press the plus/minus keys
  - ▶ Press the stages in the selection bar

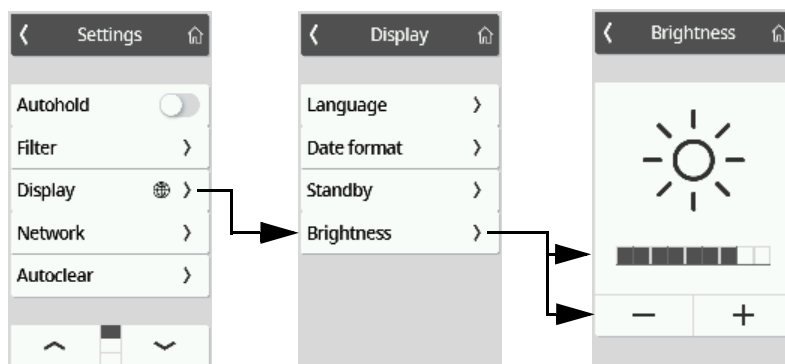

The setting is active.



5. To exit the menu, press the  key.

### Switching over units

Device mode	Function available
Basic	-
Advanced	-
Expert	•
Service	•

1. Press the  key.  
The **Settings** menu is displayed.
2. Press the  or  key until the **Display** menu item is displayed.
3. In the **Display** menu, select the **Units** item.
4. Press the desired system of units.  
The setting is active.  
Measuring results are displayed in the selected system of units.



5. To exit the menu, press the  key.

## 7.4 Setting up network functions



### CAUTION!

#### Malfunction, implausible measuring results

If network settings are not carried out correctly, measuring results can be assigned incorrectly or lost.

- ▶ Have the steps described in this section carried out by your administrator or hospital technician. If you have any questions, contact seca Service.

### NOTE

As soon as the device is connected to a network, the **Autohold** function is activated automatically. The **Autohold** function cannot be deactivated if the device is connected to a network.

The following requirements must be met to be able to assign measured values to an electronic patient file in an EMR System or the **seca analytics 125** software:

- Device is set up in the **seca connect 103** software
- Device is connected to your network via a LAN or WiFi connection
- An interface is set up in the **seca connect 103** software to your EMR System or the **seca analytics 125** software
- Barcode scanner is connected to the device



On connection to an EMR System, the measurement procedure consists of the following steps:

- Record ID(s) using barcode scanner
- Record measured values on the device
- Use the **seca connect 103** software to transmit the measuring results to the EMR System

### NOTE

The measurement procedure (workflow settings) can be individually adapted in the **seca connect 103** software.

### Setting up the device in the **seca connect 103** software

For data transmission between the device and your EMR System, the device must be set up in the **seca connect 103** software. Amongst others, the following data must be entered:

- Device name
  - Setup location
  - Workflow settings (measurement procedure)
  - Address of the **seca connect 103** server
  - Network port
1. Set up the device in the **seca connect 103** software as described in the system instructions for use for the **seca connect 103** software. The software generates a QR code containing the entered information.
  2. Make sure that a barcode scanner is connected to the device  
→ [Connecting a barcode scanner \(optional\), page 94](#).
  3. Scan the QR code from the software user interface or a paper printout. The settings carried out in the **seca connect 103** software are stored in the device.

4. You have the following options for continuing:
  - ▶ LAN: Connect the device to the network using a LAN cable
  - ▶ WiFi: → [Connecting the device to the WiFi network \(seca connect 103\), page 117](#)

**NOTICE!**

**Malfunction**

To be able to transmit measuring results to an EMR System, an interface must be set up between the **seca connect 103** software and the EMR System.





- ▶ Observe the system instructions for use for the **seca connect 103**.
- ▶ Set up the interface in cooperation with the manufacturer of your EMR System.

**Entering the IP address**

Device mode	Function available
<b>Basic</b>	-
<b>Advanced</b>	-
<b>Expert</b>	•
<b>Service</b>	•

**NOTE**

Manual entry is only necessary if no barcode scanner is connected to your device. If a barcode scanner is connected, the network connection can be set up from the **seca connect 103** software.

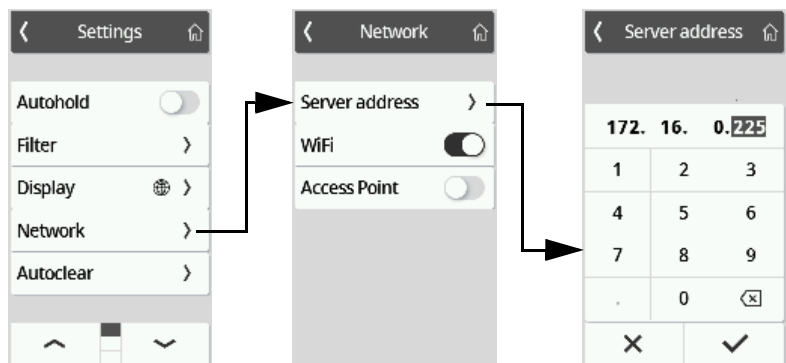

1. Press the  key.  
The **Settings** menu is displayed.
2. Press the  or  key until the **Network** menu item is displayed.
3. Press the **Network** item.
4. Press the **Server address** item.
5. Enter the IP address of the server on which the **seca connect 103** software is installed:
  - a) Enter the value
  - b) Confirm your entry by pressing the  key







6. You have the following options for continuing:
  - ▶ Connect the device to the network using a LAN cable
  - ▶ Establish a WiFi connection → [Connecting the device to the WiFi network \(seca connect 103\), page 117](#)

## Activating/deactivating the WiFi function

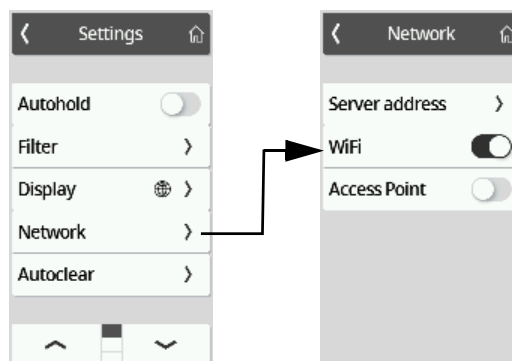
To activate/deactivate the WiFi function for the device, proceed as follows:

1. Press the  key.  
The **Settings** menu is displayed.
2. Press the  or  key until the **Network** menu item is displayed.
3. Press the **Network** item.  
The current setting is displayed.



4. Press the desired setting for the **WiFi** item:
  -  Function activated
  -  Function deactivated
5. To exit the menu, press the  key.

## Connecting the device to the WiFi network (seca connect 103)

Device mode	Function available
<b>Basic</b>	-
<b>Advanced</b>	-
<b>Expert</b>	•
<b>Service</b>	•

Connect your device to the WiFi network via the **seca connect 103** software if you do not have access to the WPS function of the router or want to integrate several devices:

1. Make sure that the WiFi function of the device is activated → [Activating/deactivating the WiFi function, page 117](#).
2. Enter the data for the WiFi network in the **seca connect 103** software as described in the system instructions for use for the software.  
The software generates a QR code containing the entered information.
3. Make sure that a barcode scanner is connected to the device  
→ [Connecting a barcode scanner \(optional\), page 94](#).
4. Scan the QR code from the software user interface.  
The settings carried out in the **seca connect 103** software are stored in the device.  
The device connects to the router of the WiFi network.  
As soon as the device is connected to the WiFi network, the  symbol is permanently on.

## Connecting the device to the WiFi network (WPS)

Connect your device to the WiFi network via WPS if no barcode scanner is connected to the device and you have access to the router.

1. Make sure that the WiFi function of the device is activated → [Activating/deactivating the WiFi function, page 117](#).
2. Press the WPS button on the router and on the connection panel on the weighing platform.

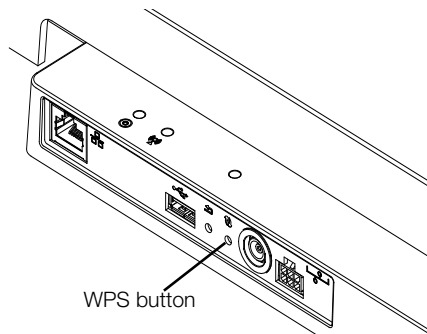

**Automatically clearing measured values (Autoclear)**

The device connects to the router of the WiFi network.

As soon as the device is connected to the WiFi network, the  symbol is permanently on.

**NOTICE!**

**Malfunction, incomplete data transmission**





Further settings have to be carried out to enable the transmission of measurement data to an EMR System via the **seca connect 103** software.

- ▶ Observe the system instructions for use for the **seca connect 103**.

Device mode	Function available
<b>Basic</b>	-
<b>Advanced</b>	-
<b>Expert</b>	•
<b>Service</b>	•

Out-of-date measuring results and patient data lead to incorrect calculation of the BMI or BSA or to implausible bioimpedance analyses. The period of time after which the following parameters are cleared automatically can be set:

- Weight
- Height
- **BMI**
- **BSA**

1. Press the  key.  
The **Settings** menu is displayed.
2. Press the  or  key until the **Autoclear** menu item is displayed.
3. Press the **Autoclear** item.
4. Specify the time after which the device is to clear measuring results and patient data:
  - a) Enter value (minimum: 1sec./maximum: 3600 sec./1 h)
  - b) Confirm your entry by pressing the  key

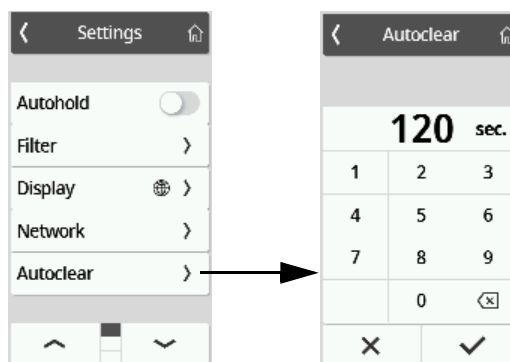



5. To exit the menu, press the  key.

## 7.5 Configuring voice guidance

### Selecting a language

Device mode	Function available
<b>Basic</b>	-
<b>Advanced</b>	•
<b>Expert</b>	•
<b>Service</b>	•

To change the language, proceed as follows:

1. Press the  key.  
The **Settings** menu is displayed.
2. Press the  or  key until the **Voice guidance** menu item is displayed.
3. In the **Voice guidance** menu, select the **Language** item.

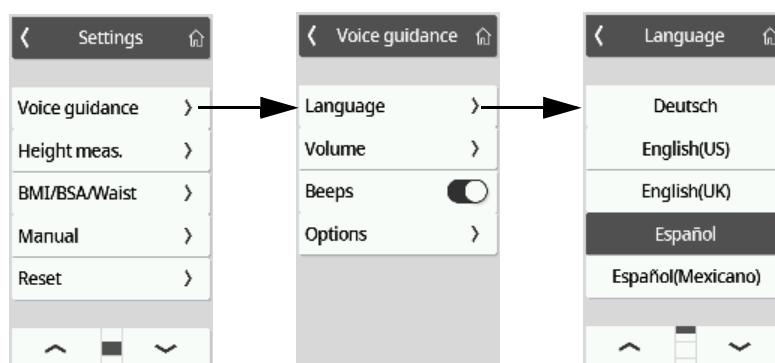



4. Select a language.
  - a) Press the arrow keys until the desired language appears on the display
  - b) Press the desired language
 The setting is active.
5. To exit the menu, press the  key.

### Setting the volume

Device mode	Function available
<b>Basic</b>	-
<b>Advanced</b>	•
<b>Expert</b>	•
<b>Service</b>	•

The voice output volume can be adjusted in stages (0 = off, 9 = max.).

1. Press the  key.  
The **Settings** menu is displayed.
2. Press the  or  key until the **Voice guidance** menu item is displayed.

3. In the **Voice guidance** menu, select the **Volume** item.

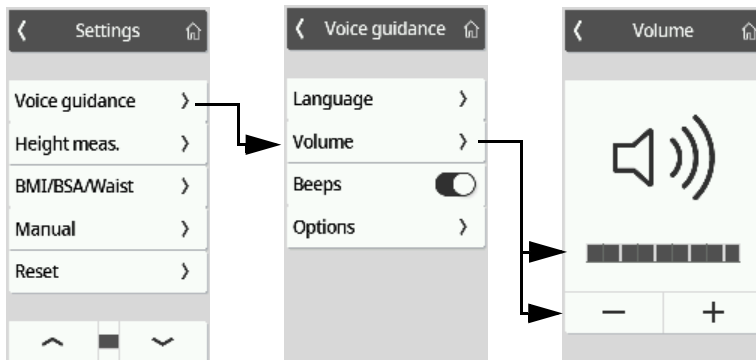

4. Adjust the volume:

- ▶ Press the plus/minus keys
- ▶ Press the stages in the selection bar

The setting is active.

5. To exit the menu, press the  key.



### Activating/deactivating beeps

Device mode	Function available
<b>Basic</b>	-
<b>Advanced</b>	-
<b>Expert</b>	•
<b>Service</b>	•

Beeps can be activated for measuring height in order to indicate the beginning and end of a measurement procedure.

1. Press the  key.



The **Settings (Einstellungen)** menu is displayed.

2. Press the  or  key until the **Voice guidance** menu item is displayed.

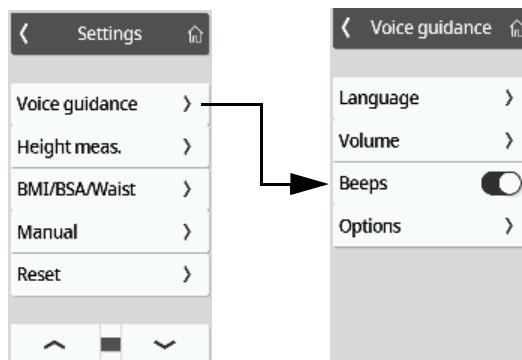
3. In the **Voice guidance** menu, select the **Beeps** item.



4. Select the desired setting for the **Beeps** item:

-  Function activated
-  Function deactivated

5. To exit the menu, press the  key.





### Activating/deactivating the announcement of patient instructions (Measurement)

Device mode	Function available
<b>Basic</b>	-
<b>Advanced</b>	-
<b>Expert</b>	•
<b>Service</b>	•



The device can be set so that the patient is guided through the measurement procedure by voice outputs.

#### NOTE

Select a language the patient understands → [Selecting a language, page 119](#).

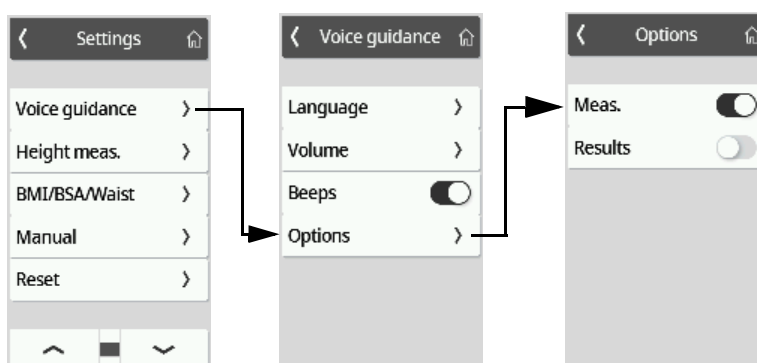
1. Press the  key.  
The **Settings** menu is displayed.
2. Press the  or  key until the **Voice guidance** menu item is displayed.
3. In the **Voice guidance** menu, select the **Options** item.



4. Select the desired setting for the **Meas.** item:
  -  Function activated
  -  Function deactivated
5. To exit the menu, press the  key.



### Activating/deactivating the announcement of measuring results (Results)

Device mode	Function available
<b>Basic</b>	-
<b>Advanced</b>	-
<b>Expert</b>	•
<b>Service</b>	•

You can set the device so that the measuring results (weight, height and BMI) are announced after every measurement procedure.

#### NOTE

Select a language the patient understands → [Selecting a language, page 119](#).

1. Press the  key.  
The **Settings** menu is displayed.
2. Press the  or  key until the **Voice guidance** menu item is displayed.

3. In the **Voice guidance** menu, select the **Options** item.

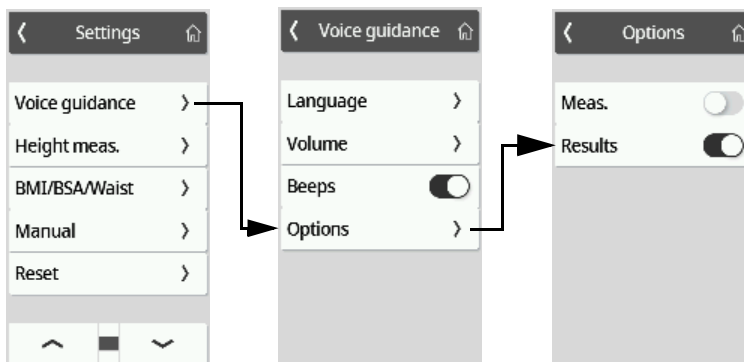

4. Select the desired setting for the **Results** item:

- Function activated
- Function deactivated

5. To exit the menu, press the  key.

## 7.6 Factory settings

Device mode	Function available
<b>Basic</b>	-
<b>Advanced</b>	-
<b>Expert</b>	•
<b>Service</b>	•

### Overview of factory settings

Function	Factory setting
<b>Hold</b>	Off
<b>Tare</b>	0 kg
<b>Pre-tare</b>	0 kg
<b>Height</b>	0 cm
<b>Autohold</b>	Off
<b>Device mode</b>	Expert
<b>Autoclear</b>	300 sec.
<b>Filter</b>	Medium
<b>Display: Language</b>	English
<b>Display: Date format</b>	YYYY/MM/DD
<b>Display: Standby</b>	Off
<b>Display: Brightness</b>	Stage 7 of 9
<b>Voice guidance: Language</b>	English
<b>Voice guidance: Volume</b>	Stage 5 of 9
<b>Voice guidance: Beeps</b>	On
<b>Voice guidance: Meas.</b>	On
<b>Voice guidance: Results</b>	On
<b>BMI/BSA/Waist</b>	BMI
<b>Units</b>	Metric (kg, cm)
<b>Server address</b>	None
<b>WiFi<sup>a</sup></b>	On
<b>Access Point<sup>a</sup></b>	Off

a. Individual settings are **not** reset when factory settings are restored.

**Restoring factory settings**

1. Press the  key.  
The **Settings** menu is displayed.
2. Press the  or  key until the **Voice guidance** menu item is displayed.
3. Press the **Reset** item.

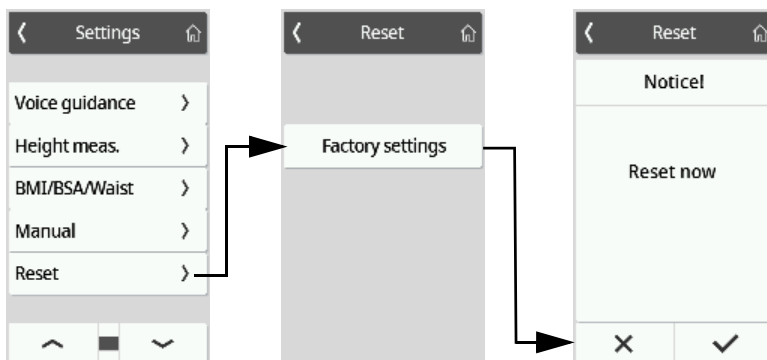

4. Press the **Factory settings** key.  
The device will be reset to factory settings.  
The following network settings are **not** reset:
  - Server address
  - Server port
  - WiFi
  - Access point
5. Confirm your selection.
6. Confirm the prompt on the display with the  key.  
You exit the menu automatically.  
The device will be reset to factory settings.

## 8. HYGIENE TREATMENT

**WARNING!**  
**Electric shock**

The device is not de-energized when the display goes out. Use of fluids on the device may cause electric shock.

- ▶ Disconnect the power supply connector before performing any hygiene treatment.
- ▶ Ensure that no fluids penetrate the device.

**NOTICE!****Damage to device**

Inappropriate detergents and disinfectants may damage the sensitive surfaces of the device.

- ▶ Use alcohol-based disinfectant (e.g. 70 % ethanol) exclusively.
- ▶ Do not use aggressive or abrasive cleaning agents.
- ▶ Ensure that no moisture or dust get into the sensors during cleaning.

### 8.1 Cleaning

- ▶ Use a soft cloth dampened with mild soapsuds to clean the surfaces of the device.

## 8.2 Disinfecting

1. Use an alcohol-based disinfectant (e.g. 70 % ethanol).
2. Follow the instructions on the disinfectant.
3. Disinfect the device:
  - ▶ Moisten a soft cloth with disinfectant and wipe down the device with it.
  - ▶ Comply with the intervals, see table.

Interval	Component
<b>Before</b> every measurement	<ul style="list-style-type: none"><li>• Weighing platform</li><li>• Standing aid (devices with standing aid)</li></ul>
<b>After</b> every measurement	<ul style="list-style-type: none"><li>• Weighing platform</li><li>• Standing aid (devices with standing aid)</li></ul>
If required	<ul style="list-style-type: none"><li>• Multifunctional display</li><li>• Column (devices with measuring rod)</li><li>• Measuring head (devices with measuring rod)</li></ul>

## 8.3 Sterilizing

This device may not be sterilised.

## 9. FUNCTION CHECK

- ▶ Perform a function check prior to each use.

A complete function check includes:

- Visual inspection for mechanical damage
- Checking the alignment of the device
- Visual and function check of the display elements
- Function check of all the controls shown in the section entitled “Overview”
- Function check of optional accessories

If you notice any faults or deviations during the function check, first try to resolve the error with the aid of the section entitled “Troubleshooting” in this document.



### **CAUTION!**

#### **Personal injury**

If you notice any faults or deviations during the function check which cannot be resolved with the aid of the section entitled “Troubleshooting” in this document, you may not use the device.

- ▶ Have the device repaired by seca Service or by an authorized service partner.
- ▶ Follow the section entitled “Servicing” in this document.

## 10. TROUBLESHOOTING

If faults occur when operating the device, first attempt to remedy them yourself using the following tables. If the fault persists, contact seca Service.

With some faults, an error code appears on the multifunctional display. Please indicate the error code when contacting seca Service.

Information about display messages and the structure of error codes can be found here:

→ [Display message traffic light system, page 129](#)

→ [Error codes, page 129](#)

### 10.1 General faults

Fault	Cause	Remedy
<b>No menu access possible</b>	<b>Basic</b> device mode active	Clarify with the administrator/hospital technician whether the device can be operated in another device mode <ul style="list-style-type: none"> <li>→ <a href="#">Changing the device mode, page 106</a></li> <li>→ <a href="#">Functions/device mode, page 134</a></li> </ul>
<b>Required function not available</b>	Device mode active in which the function is not intended	Clarify with the administrator/hospital technician whether the device can be operated in another device mode <ul style="list-style-type: none"> <li>→ <a href="#">Changing the device mode, page 106</a></li> <li>→ <a href="#">Functions/device mode, page 134</a></li> </ul>
<b>Multifunctional display does not react when keys are pressed</b>	Device is in an undefined state following implausible inputs.	<ul style="list-style-type: none"> <li>Disconnect the plug-in power supply unit from the socket</li> <li>Wait approx. 1 minute</li> <li>Plug the plug-in power supply unit into the socket; the device and the multifunctional display switch on automatically</li> </ul>
	With device combinations with a standing aid and/or measuring rod: Additional display connected	<ul style="list-style-type: none"> <li>Remove the second display</li> <li>Disconnect the plug-in power supply unit from the socket</li> <li>Wait approx. 1 minute</li> <li>Plug the plug-in power supply unit into the socket; the device and the multifunctional display switch on automatically</li> </ul>
<b>Multifunctional display remains dark after pressing</b>	Device is in an undefined state following implausible inputs.	<ul style="list-style-type: none"> <li>Disconnect the plug-in power supply unit from the socket</li> <li>Wait approx. 1 minute</li> <li>Plug the plug-in power supply unit into the socket; the device and the multifunctional display switch on automatically</li> </ul>
	Multifunctional display defective	Inform seca Service

### 10.2 Measuring weight

Fault/error code	Cause	Remedy
<b>Displayed weight value is implausible</b>	Weighing electronics use outdated zero point	<ul style="list-style-type: none"> <li>Remove the weight from the weighing platform</li> <li>Press <b>Weight</b> display field</li> <li>Press  key: Device restart</li> <li>Wait until main screen is displayed again</li> </ul>
	Weighing electronics defective	Inform seca Service

Fault/error code	Cause	Remedy
<b>Autohold function cannot be deactivated</b>	Device is connected to a network (intended behavior): <b>Autohold</b> function is activated automatically.	If necessary, disconnect device from network
<b>001-272XX-XXX to 008-272XX-XXX</b>	Load cell or weight calculation module defective	Inform seca Service
<b>020-272XX-XXX to 023-272XX-XXX</b>	One corner of the scale has been loaded excessively.	<ul style="list-style-type: none"> <li>• Distribute weight evenly</li> </ul>
		<ul style="list-style-type: none"> <li>• Disconnect the plug-in power supply unit from the socket</li> <li>• Plug the plug-in power supply unit into the socket; the device and the multifunctional display switch on automatically</li> </ul>
		<ul style="list-style-type: none"> <li>• Inform seca Service</li> </ul>
<b>010-272XX-XXX</b>	The scale has been switched on with too high a load.	<ul style="list-style-type: none"> <li>• Remove the weight from the weighing platform</li> <li>• Disconnect the plug-in power supply unit from the socket</li> <li>• Plug the plug-in power supply unit into the socket; the device and the multifunctional display switch on automatically</li> </ul>
<b>013-272XX-XXX</b>	The scale was caused to oscillate and was unable to determine the zero point.	<ul style="list-style-type: none"> <li>• Disconnect the plug-in power supply unit from the socket</li> <li>• Plug the plug-in power supply unit into the socket; the device and the multifunctional display switch on automatically</li> </ul>
<b>019-272XX-XXX</b>	Ambient temperature too high or too low.	<ul style="list-style-type: none"> <li>• Observe ambient conditions for operation, transport, and storage → <a href="#">General technical data, page 135</a></li> </ul>

### 10.3 Height measurement, ultrasonic

Fault/error code	Cause	Remedy
 <b>symbol appears during calibration</b>	Calibration failed	<ul style="list-style-type: none"> <li>• Make sure that no objects or people are in the immediate vicinity of the device during calibration</li> <li>• Make sure that the supplied calibration rod was used</li> <li>• Make sure that the calibration rod is positioned centrally on the foot silhouettes of the weighing platform</li> </ul>
<b>Ultrasound measuring head status LED does not light up</b>	Device is in an undefined state following implausible inputs.	<ul style="list-style-type: none"> <li>• Take power supply unit out of the socket</li> <li>• Wait approx. 1 minute</li> <li>• Plug the power supply unit into the socket; the device and the multifunctional display switch on automatically</li> </ul>
	Wiring in the ultrasound measuring head incorrect	Wire the ultrasound measuring head as described in the corresponding assembly instructions
	The status LED is defective.	Inform seca Service

Fault/error code	Cause	Remedy
<b>Foot silhouettes on the weighing platform do not light up</b>	Device is in an undefined state following implausible inputs.	<ul style="list-style-type: none"> <li>• Disconnect the plug-in power supply unit from the socket</li> <li>• Wait approx. 1 minute</li> <li>• Plug the plug-in power supply unit into the socket; the device and the multifunctional display switch on automatically</li> </ul>
	The foot silhouette illumination is defective.	Inform seca Service
<b>Patient instructions are not announced</b>	Function not activated	Activate function → <a href="#">Activating/deactivating the announcement of patient instructions (Measurement), page 121</a>
	Volume set to zero	Increase volume
	Loudspeaker is defective	Inform seca Service
<b>No beeps audible</b>	Function not activated	Activate function → <a href="#">Activating/deactivating beeps, page 120</a>
	Volume set to zero	Increase volume
	Loudspeaker is defective	Inform seca Service
<b>Measuring results are not announced</b>	Function not activated	Activate function → <a href="#">Activating/deactivating the announcement of measuring results (Results), page 121</a>
	Volume set to zero	Increase volume
	Loudspeaker is defective	Inform seca Service
<b>080-297XX-XXX</b>	Voice output memory cannot be read.	Inform seca Service
		Deactivate beeps and voice outputs to suppress the error message until repair is carried out: <ul style="list-style-type: none"> <li>• Deactivate announcement of patient instructions → <a href="#">Activating/deactivating the announcement of patient instructions (Measurement), page 121</a></li> <li>• Deactivate announcement of measuring results → <a href="#">Activating/deactivating the announcement of measuring results (Results), page 121</a></li> <li>• Deactivate beeps → <a href="#">Configuring voice guidance, page 119</a></li> </ul>
<b>081-297XX-XXX</b>	Voice file not found.	Inform seca Service
		Deactivate beeps and voice outputs to suppress the error message until repair is carried out: <ul style="list-style-type: none"> <li>• Deactivate announcement of patient instructions → <a href="#">Activating/deactivating the announcement of patient instructions (Measurement), page 121</a></li> <li>• Deactivate announcement of measuring results → <a href="#">Activating/deactivating the announcement of measuring results (Results), page 121</a></li> <li>• Deactivate beeps → <a href="#">Activating/deactivating beeps, page 120</a></li> </ul>
<b>082-297XX-XXX</b>	An error occurred during the measurement procedure.	Repeat measurement procedure and ask the patient to remain standing still
		If the error occurs again, inform seca Service

Fault/error code	Cause	Remedy
083-297XX-XXX	An error occurred during the calibration procedure.	<ul style="list-style-type: none"> <li>Remove objects from the immediate vicinity of the device → <a href="#">Setting up the device, page 93</a>.</li> <li>Ask persons in the vicinity to remain further away from the device → <a href="#">Setting up the device, page 93</a></li> </ul>
	Interference caused by reflection	
	Interference caused by other ultrasonic emitters	Increase the distance from other ultrasonic emitters → <a href="#">Setting up the device, page 93</a>
084-297XX-XXX	The ambient temperature is too high or too low.	<ul style="list-style-type: none"> <li>Observe ambient conditions for operation, transport, and storage → <a href="#">General technical data, page 135</a></li> </ul>
	The temperature sensor is defective.	Inform seca Service
099-297XX-XXX	Voice guidance: Language that does not support the announcement of measuring results in imperial units active. Announcement of the measuring results was automatically deactivated.	Set metric units and activate announcement of the measuring results → <a href="#">Switching over units, page 114</a> → <a href="#">Activating/deactivating the announcement of measuring results (Results), page 121</a>
		Select language that supports announcement of the measuring results in imperial units (EN (US/UK), ES/ES-MX) and activate announcement of the measuring results. → <a href="#">Selecting a language, page 119</a> → <a href="#">Activating/deactivating the announcement of measuring results (Results), page 121</a>

## 10.4 Data transmission

Fault/error code	Cause	Remedy
<b>The “Date of birth” dialog window appears after pressing the ✓ key</b>	Patient ID not scanned	<ul style="list-style-type: none"> <li>Press ✕ key</li> <li>Scan patient ID</li> </ul>
	ID scanning not set up	Check workflow settings for the device in the <b>seca connect 103</b> software
	Patient does not yet have a file in the EMR System	<ul style="list-style-type: none"> <li>Enter date of birth and press ✓ key again</li> <li>Create patient file in the EMR System and assign measurement</li> </ul>
	Device is connected to the <b>seca analytics 125</b> software	<ul style="list-style-type: none"> <li>Enter date of birth</li> <li>Press ✓ key</li> </ul>
<b>Autoclear function: Entering “0 seconds” is not accepted; instead, the factory setting (300 seconds) is suggested</b>	Implausible input; switching off the function is not intended in the factory	<ul style="list-style-type: none"> <li>Accept factory setting</li> <li>Manually enter value between 1 and 3600 seconds</li> </ul>
<b>Workflow LED does not light up</b>	No network connection	Set up network connection → <a href="#">Setting up network functions, page 115</a>
	WiFi function deactivated	Activate WiFi function → <a href="#">Activating/deactivating the WiFi function, page 117</a>
	Workflow LED is defective	Inform seca Service



Fault/error code	Cause	Remedy
<b>Workflow LED lights up red</b>	ID was <b>not</b> found in the EMR System or the seca software	Create the ID in the EMR System or the seca software
	Device has <b>not</b> saved measuring results to the clipboard.	Repeat measurement
	The measuring results were <b>not</b> submitted to an EMR System or seca software.	<ul style="list-style-type: none"> <li>• Repeat measurement</li> <li>• Check WiFi connection</li> </ul>
<b>02-288XX-XXX</b>	No data transmission possible	Check network and workflow settings: <ul style="list-style-type: none"> <li>• Check network settings → <a href="#">Setting up network functions, page 115</a></li> <li>• Check workflow settings: <b>seca connect 103</b> system instructions for use</li> </ul>
<b>052-280XX-XXX</b>	Internal device communication error	<ul style="list-style-type: none"> <li>• Disconnect the plug-in power supply unit from the socket</li> <li>• Wait approx. 1 minute</li> <li>• Plug the plug-in power supply unit into the socket; the device and the multifunctional display switch on automatically</li> <li>• Inform seca Service</li> </ul>
<b>420-280XX-XXX</b>	No connection to the server	<ul style="list-style-type: none"> <li>• Check LAN cable</li> <li>• Check network settings → <a href="#">Setting up network functions, page 115</a></li> </ul>

### 10.5 Display message traffic light system

Symbol	Description
	Green: Action successful, e.g. data submitted to EMR System or <b>seca analytics 125</b> software
	Yellow: Incorrect operation or malfunction, can be remedied by the user with the aid of the error tables in these instructions for use → <a href="#">Troubleshooting, page 125</a> .
	Red: Device error that cannot be remedied by the user. Inform seca Service.

### 10.6 Error codes

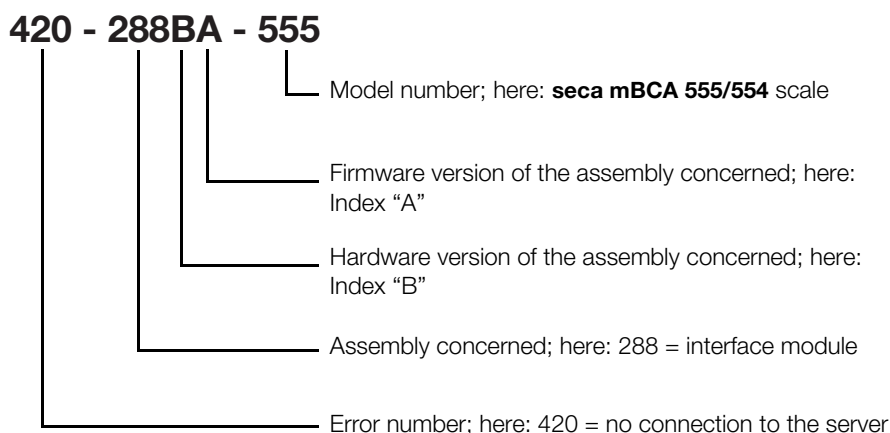

# 11.SERVICING

## 11.1 Calibrated scales (read off calibration counter and GAL value)

We recommend having your device serviced prior to verification.

### NOTICE!

#### Incorrect measurements as a result of poor servicing



- ▶ Have servicing and repairs carried out exclusively by seca Service or by an authorized service partner.
- ▶ You can find service partners in your area at [www.seca.com](http://www.seca.com) or by sending an e-mail to [service@seca.com](mailto:service@seca.com).

Have an authorized technician perform verification according to national legal regulations.

Verification is necessary whenever one or more verification seals are damaged or the contents of the verification counter no longer match the number on the applicable verification counter sticker. If verification seals are damaged, contact seca Service directly.

Verifications may only be performed by authorized agencies. To guarantee this, the scale is equipped with a verification counter to record any change in verification-related data. The GAL value used by the device can also be read off.

If you want to check whether the scale has been properly verified, proceed as follows:

1. Press the  key.  
The **Settings** menu is displayed.
2. Select the **About** item in the menu.
3. Use the   keys to select the **Verification** view.



4. Read off the GAL value (figure shows example values).



5. Read off the calibration counter.

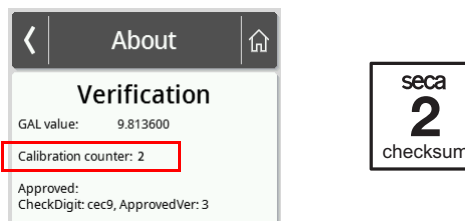

The value must match the number indicated on the calibration counter seal (figure shows example values).

Both numbers have to match for the verification to be valid. If the sticker and the verification counter do not match, the scale must be verified. Please contact your service partner or seca Service. Once the scale has been verified, a new, updated verification counter sticker is used to identify the status of the verification counter. The person authorized to perform the verification secures this sticker with an additional seal. The verification counter sticker can be ordered from seca Service.

## 11.2 Non-calibrated scales

---

The product must be set up carefully and serviced regularly. Depending on how frequently the product is used, we recommended servicing at intervals of 3 to 5 years.



### **CAUTION!**

#### **Incorrect measurements as a result of poor servicing**

- ▶ Have servicing and repairs carried out exclusively by seca Service or by an authorized service partner.
- ▶ You can find service partners in your area at [www.seca.com](http://www.seca.com) or by sending an e-mail to [service@seca.com](mailto:service@seca.com).

# 12. TECHNICAL DATA

## 12.1 Menu structures

**“Basic” device mode** Access to the menu is not possible in **Basic** device mode.

**“Advanced” device mode**

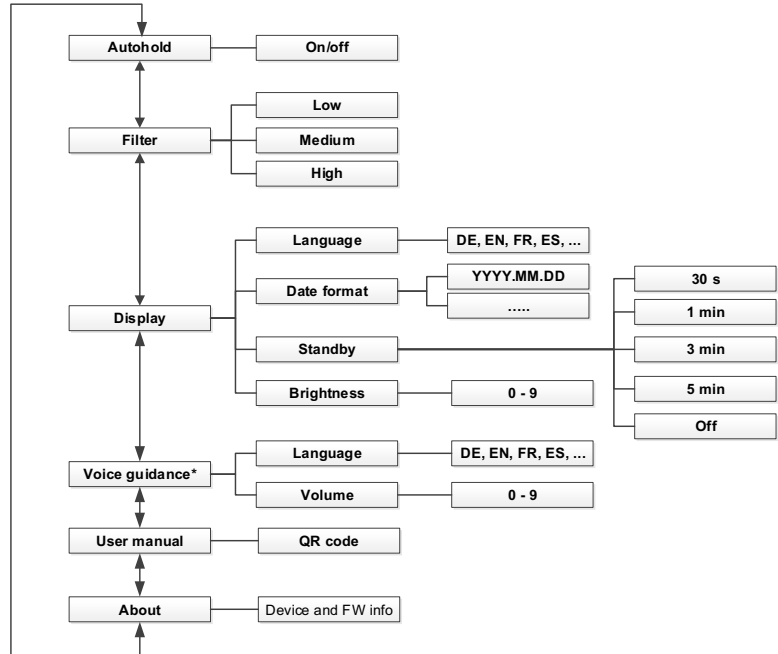

\*Device combinations with ultrasonic measuring rod

“Expert”/“Service” device modes

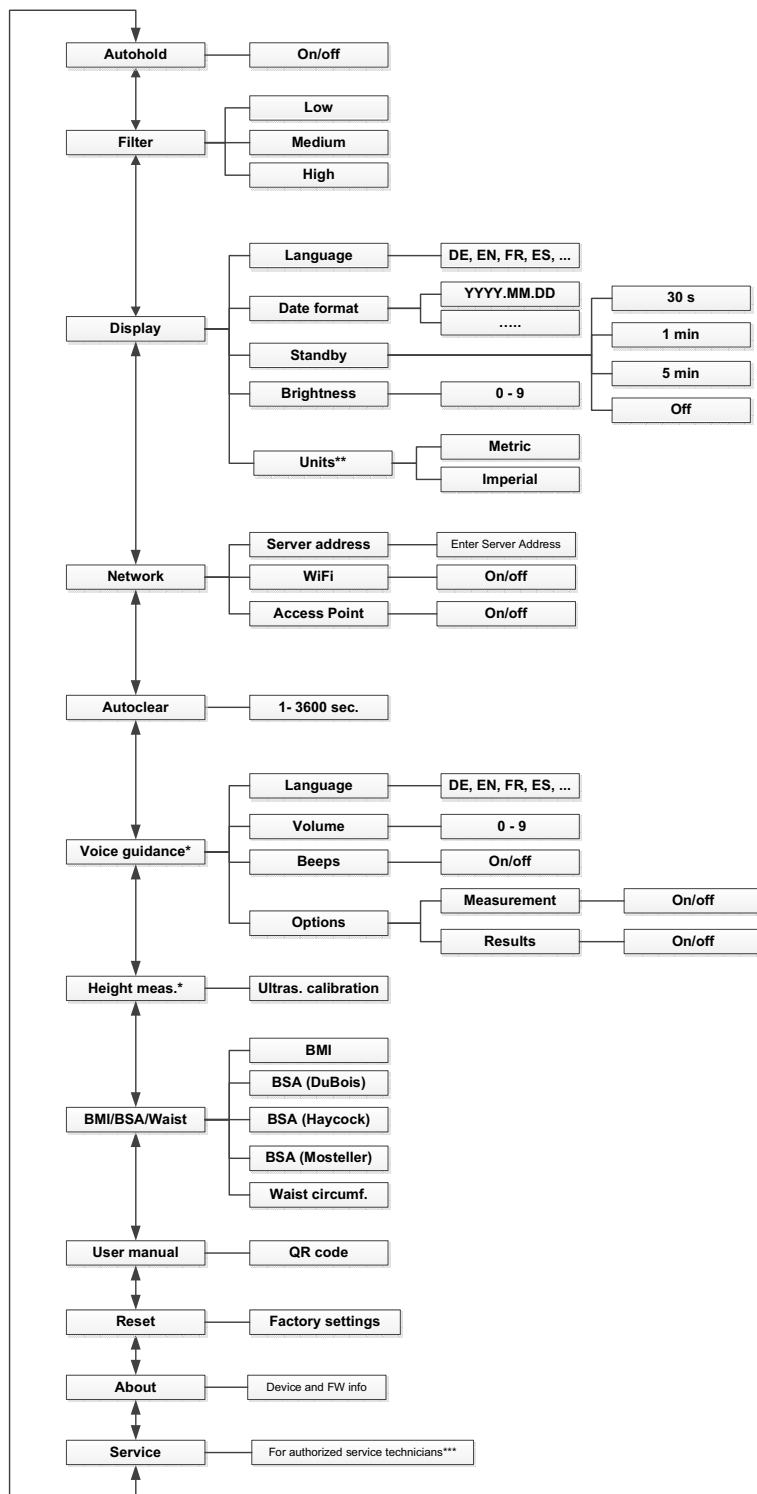

\*Device combinations with ultrasonic measuring rod

\*\*Non-calibrated scales

\*\*\*Service partners at [www.seca.com](http://www.seca.com) or by e-mail: [service@seca.com](mailto:service@seca.com)

## 12.2 Functions/device mode

Function	Device mode			
	Basic	Advanced	Expert	Service
<b>Measure</b>				
Calculate BMI/BSA automatically	•	•	•	•
Measure weight	•	•	•	•
Record IDs (user/patient) <sup>a</sup>	•	•	•	•
Enter height manually	•	•	•	•
Measure height	•	•	•	•
Permanently display measuring results (Hold)	–	•	•	•
Submit measuring results <sup>a</sup>	•	•	•	•
Enter waist circumference	–	•	•	•
Tare additional weight (tare)	–	•	•	•
Permanently save the additional weight	–	•	•	•
<b>Configure</b>				
Activate/deactivate announcement of measuring results (Results)	–	–	•	•
Activate/deactivate announcement of patient instructions (Measurement)	–	–	•	•
Access PDF version of the instructions for use (QR code)	–	•	•	•
<b>Autoclear</b> function: Define time period	–	–	•	•
Activate <b>Autohold</b> function	–	•	•	•
Set filter (sensitivity of the scale to patient movements)	–	•	•	•
Set date format	–	•	•	•
Set display brightness	–	•	•	•
Set display language	–	•	•	•
Read off calibration counter reading (calibrated scales)	–	•	•	•
Switch over units (non-calibrated scales)	–	–	•	•
Read off GAL value	–	•	•	•
Connect device to WiFi network (WPS)	–	–	•	•
Connect device to WiFi network (manually)	–	–	•	•
Connect devices to WiFi network (seca connect 103)	–	–	•	•
Enter IP address	–	–	•	•
Set volume for voice guidance	–	•	•	•
Call up menu	–	•	•	•
Service functions <sup>b</sup>	–	–	–	•
Activate/deactivate beeps for ultrasonic height measurement	–	–	•	•
Select language for voice guidance	–	•	•	•
Set standby time	–	•	•	•
Calibrate ultrasonic height measurement	–	–	•	•
Switch between BMI/BSA calculation and waist circumference input	–	–	•	•
Restore factory settings	–	–	•	•
Activate/deactivate WiFi module	–	–	•	•

a. devices with connection to an EMR System or the seca analytics 125 software (via seca connect 103 software)

b. For authorized service technicians only

## 12.3 General technical data

General technical data	
Ambient conditions, operation <ul style="list-style-type: none"> <li>• Temperature</li> <li>• Air pressure</li> <li>• Humidity</li> </ul>	+10 °C to +40 °C (50 °F to 104 °F) 700 hPa – 1060 hPa 20 % – 80 %, noncondensing
Ambient conditions, storage <ul style="list-style-type: none"> <li>• Temperature</li> <li>• Air pressure</li> <li>• Humidity</li> <li>• Warm-up time from lowest storage temperature to operational temperature <ul style="list-style-type: none"> <li>- At ambient temperature 20 °C: 8 h</li> <li>- At ambient temperature 20 °C and with condensation formation: 24 h</li> </ul> </li> <li>• Cooling time from highest storage temperature to operational temperature (at ambient temperature 20 °C) 8 h</li> </ul>	-10 °C to +65 °C (14 °F to 149 °F) 700 hPa – 1060 hPa 0 % – 95 %, noncondensing
Ambient conditions, transport <ul style="list-style-type: none"> <li>• Temperature</li> <li>• Air pressure</li> <li>• Humidity</li> </ul>	-10 °C to +65 °C (14 °F to 149 °F) 700 hPa – 1060 hPa 0 % – 95 %, noncondensing
Power supply: Plug-in power supply unit <ul style="list-style-type: none"> <li>• Supply voltage</li> <li>• Maximum current consumption</li> <li>• Insulated device, protection class II (IEC 60601-1)</li> </ul>	12 V Max. 1.5 A 
Mains voltage	100 V – 240 V
Power supply frequency	50 Hz – 60 Hz
Power consumption	max. 18 W
IEC 60601-1: Medical electrical device, Type BF	
Type of protection in accordance with IEC 60529	IP 21
Duty cycle	Continuous duty
Medical device in accordance with Regulation (EU) 2017/745: <ul style="list-style-type: none"> <li>• Devices without bioimpedance measurement</li> <li>• Devices with bioimpedance measurement</li> </ul>	Class I with measuring function Class IIa
Application parts in accordance with IEC 60601-1: Scales <b>seca 651/650</b> : Scales <b>seca 655/654</b> : Scales <b>seca mBCA 555/554, seca mBCA 552</b> : Standing aid <b>seca 455</b> : BIA standing aid <b>seca mBCA 550, seca mBCA 549</b> :	Multifunctional display, glass plate Multifunctional display, glass plate Multifunctional display, glass plate, electrodes Upper railing arch Grip plates with electrodes
Interfaces: <ul style="list-style-type: none"> <li>• USB</li> <li>• WiFi</li> <li>• LAN</li> <li>• Internal bus system/multifunctional display</li> </ul>	USB 2.0, max. 500 mA IEEE 802.11b/g/n/e/i IEEE 802.3u seca Device Bus (SDB)
Minimum weight (measurement procedure triggering on device combinations with voice guidance)	0.5 kg

## 12.4 Dimensions, weight

Dimensions, weight	
<b>Scale with standing aid</b>	
Dimensions	
• Depth	653 mm
• Width	801 mm
• Height	1280 mm
Net weight	approx.. 25 g
<b>Scale with ultrasonic measuring rod</b>	
Dimensions	
• Depth	614 mm
• Width	600 mm
• Height	2387 mm
Net weight	approx. 22 kg
<b>Scale with standing aid and ultrasonic measuring rod</b>	
Dimensions	
• Depth	650 mm
• Width	801 mm
• Height	2387 mm
Net weight	approx. 29 kg

## 12.5 Weighing technology data, calibrated models

Weighing technology data, calibrated	
Calibration in accordance with Directive 2014/31/EU	Class III
Maximum capacity	
• Weighing range 1	150 kg
• Weighing range 2	300 kg
Minimum capacity	
• Weighing range 1	1 kg
• Weighing range 2	2 kg
Graduations	
• Weighing range 1	50 g
• Weighing range 2	100 g
Tare range	Up to 300 kg
Accuracy on initial calibration	
• Weighing range 1: 0 kg to 25 kg	± 25 g
• Weighing range 1: 25 kg to 100 kg	± 50 g
• Weighing range 1: 100 kg to 150 kg	± 75 g
• Weighing range 2: 0 to 50 kg	± 50 g
• Weighing range 2: 50 to 200 kg	± 100 g
• Weighing range 2: 200 to 300 kg	± 150 g

## 12.6 Weighing technology data, non-calibrated models

Weighing technology data, non-calibrated	
Maximum capacity	360 kg
Minimum capacity	1 kg
Increments	50 g
Tare range	Up to 360 kg
Accuracy:	
• 0 to 50 kg	± 50 g
• 50 kg to 360 kg	± 0.10 % ± 50 g

17-10-07-654-100\_01-2020B



## 12.7 Technical data, ultrasonic height measurement

### Metrological data

Technical data, height measurement, ultrasonic	
<ul style="list-style-type: none"> <li>Measuring range, standard</li> <li>Measuring range with standing aid/BIA standing aid</li> <li>Graduations</li> </ul>	60 cm – 220 cm 100 cm – 220 cm 1 mm
Accuracy: Measuring range: 100 to 200 cm Ambient conditions: 20 °C, no air movements, no air movement, no interfering objects in the vicinity of the measuring device	± 5 mm

### Voice outputs and acoustic signals

The device supports the measurement procedure through acoustic and optical signals and voice outputs.

The following table provides an overview of the signals and voice outputs of the device in the sequence of the measurement procedure:

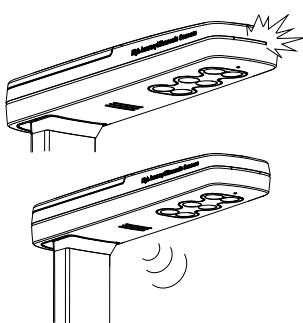





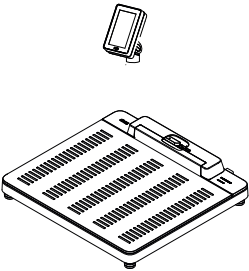
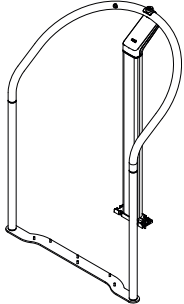

Signal/voice output	Meaning
Status LED on ultrasound head lights up continuously	The device is ready for measurement
“Please stand upright and look straight ahead.”	Instruction to the patient
Status LED on ultrasound head goes off	The measurement procedure is in progress
“Do not move. The measurement starts now.”	Instruction to the patient
Short beeps	The measurement procedure is in progress
Long beep	The measurement procedure is complete
“Your weight is (...) kilograms. Your height is (...) centimeters. Your BMI is (...)”	Announcement of the measuring results
“The measurement is completed. Please step off the platform.”	Instruction to the patient

## 13. OPTIONAL ACCESSORIES AND SPARE PARTS

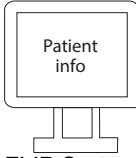
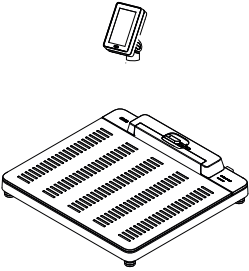
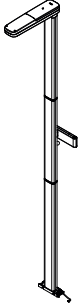
Accessory/spare part	Article number
Switch-mode power supply: 100-240 V~ / 50-60 Hz, 12 V= / 1.5 A / 18 W	68 32 10 272
Barcode scanner	See recommendation at <a href="http://www.seca.com">www.seca.com</a>
<b>seca 463</b> scanner holder	463 0000 009
<b>seca 459</b> “panda bear” figure	459 0000 009
Standing aids	See → <a href="#">Compatible seca products, page 138</a>
Measuring rods	
Configuration software	
Evaluation software	

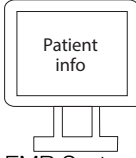
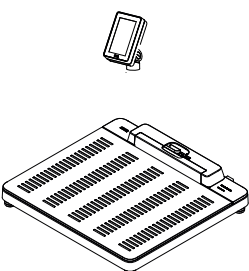
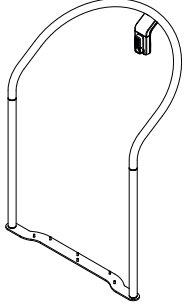
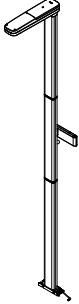
## 14. COMPATIBLE SECA PRODUCTS

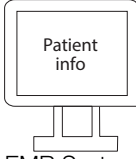
Scale	Standing aid	Measuring rod	Configuration software	EMR System <sup>a</sup>
 655 7021 099 654 1321 009	 <b>seca 455</b> 455 0001 009	-	 <b>seca connect 103</b>	 Patient info EMR System
 655 7021 099 654 1321 009	-	 <b>seca 257</b> 257 1714 009	 <b>seca connect 103</b>	 Patient info EMR System
 655 7021 099 654 1321 009	 <b>seca 455</b> 455 0002 009	 <b>seca 257</b> 257 1714 009	 <b>seca connect 103</b>	 Patient info EMR System

a. Not available from seca. seca Service will be pleased to assist if you have any questions concerning the compatibility of your EMR System.

## 15. DISPOSAL



Do not dispose of the device with household waste. The device must be disposed of properly as electronic waste. Comply with the national provisions applicable in your country. For further information contact our service department at:

**service@seca.com**

## 16. WARRANTY

We offer a two-year warranty from the date of delivery for defects attributable to faulty material or poor workmanship. This excludes all moveable parts such as (rechargeable) batteries, cables, power supply units, etc. Defects which are covered by the warranty shall be rectified free of charge for customers on production of the sales receipt. No further claims can be accepted. The costs of shipment in both directions shall be borne by the customer where the device is not located at the customer's premises. In the event of any damage during shipment warranty claims can only be asserted where the complete original packaging was used for shipment and the device was secured inside in the same manner as in the original packaging. You should therefore keep all packaging.

The warranty shall become null and void where the device is opened by persons not expressly authorised to do so by seca.

In the event of a warranty issue, please contact your local seca office or the dealer from whom you ordered the product.

## 17. DECLARATION OF CONFORMITY

### 17.1 Europe

Calibrated devices:



Non-calibrated devices:



seca gmbh & co. kg hereby declares that the product meets the terms of the applicable European directives. The unabridged declaration of conformity can be found at: [www.seca.com](http://www.seca.com).

### 17.2 USA and Canada

seca 651/650  
seca 655/654  
seca mBCA 555/554/552



WiFi Module:  
FCC 2AC7Z-ESPWROOM02  
IC 21098-ESPWROOM02

This device complies with Part 15 of the FCC Rules and with RSS-210 of Industry Canada. Operation is subject to the following two conditions. (1) this device may not cause harmful interference, and (2) this device must accept any interference received, including interference that may cause undesired operation.

#### NOTE

This device complies with Part 15 of the FCC Rules and with RSS-210 of Industry Canada. Operation is subject to the following two conditions:

- This device may not cause harmful interference.
- This device must accept any interference received, including interference that may cause undesired operation.

#### NOTE

Changes or modifications made to this equipment not expressly approved by seca may void the FCC authorization to operate this equipment.